

## FEATURES

- | Low profile package
- | Ideal for automated placement
- | 3000 Watt peak pulse power capability with a 10/1000 $\mu$ s waveform
- | For surface mounted applications to optimize board space
- | Excellent clamping capability
- | Very fast response time
- | Low incremental surge resistance

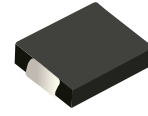

DO-214AB(SMC)

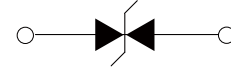

Schematic Symbol

## APPLICATIONS

- | Power supply protection
- | Automotive application
- | Industrial application
- | Power management

## APPROVALS

|             |                                    |
|-------------|------------------------------------|
| <b>RoHS</b> | Compliance with 2011/65/EU         |
| <b>HF</b>   | Compliance with IEC61249-2-21:2003 |

## MAXIMUM RATINGS ( $T_A=25^{\circ}\text{C}$ )

| Parameter   | Symbol    | Value | Unit  |
|---|-----------|-------|-------|
| Peak Pulse Power Dissipation on 10/1000 $\mu$ s waveform (Note1, Note2).                        | $P_{PPM}$ | 3000  | Watts |
| Steady State Power Dissipation at $T_L=50^{\circ}\text{C}$ , Lead lengths.375" (9.5mm) ( Note2) | $P_D$     | 6.5   | Watts |

- Notes :** 1.Non-repetitive current pulse,  $T_A=25^{\circ}\text{C}$ .  
 2.Mounted on 5.0mm\*5.0mm (0.03mm thick) Copper Pads to each terminal.

## THERMAL CONSIDERATIONS

| Parameter                              | Symbol          | Value       | Unit                        |
|--|-----------------|-------------|-----------------------------|
| Operating Junction Temperature         | $T_J$           | -55 to +150 | $^{\circ}\text{C}$          |
| Storage Temperature Range              | $T_{STG}$       | -55 to +150 | $^{\circ}\text{C}$          |
| Junction to Ambient on printed circuit | $R_{\theta JA}$ | 75          | $^{\circ}\text{C}/\text{W}$ |

## ELECTRICAL CHARACTERISTICS (T<sub>A</sub>=25°C)

| Part Number | Device Marking Code | Reverse Stand-off Voltage | Breakdown Voltage Min.@I <sub>T</sub> | Breakdown Voltage Max.@I <sub>T</sub> | Test Current        | Maximum Clamping Voltage @I <sub>PP</sub> | Peak Pulse Current  | Reverse Leakage @V <sub>RWM</sub> |
|-------------|---------------------|---------------------------|---------------------------------------|---------------------------------------|---------------------|---|---------------------|-----------------------------------|
|             |                     | V <sub>RWM</sub> (V)      | V <sub>BR</sub> (V)                   | V <sub>BR</sub> (V)                   | I <sub>T</sub> (mA) | V <sub>C</sub> (V)                        | I <sub>PP</sub> (A) | I <sub>R</sub> (μA)               |
| SVC300B100  | DGZ                 | 100.0                     | 111.0                                 | 123.0                                 | 1.0                 | 162.0                                     | 18.5                | 2.0                               |

## CHARACTERISTIC CURVES

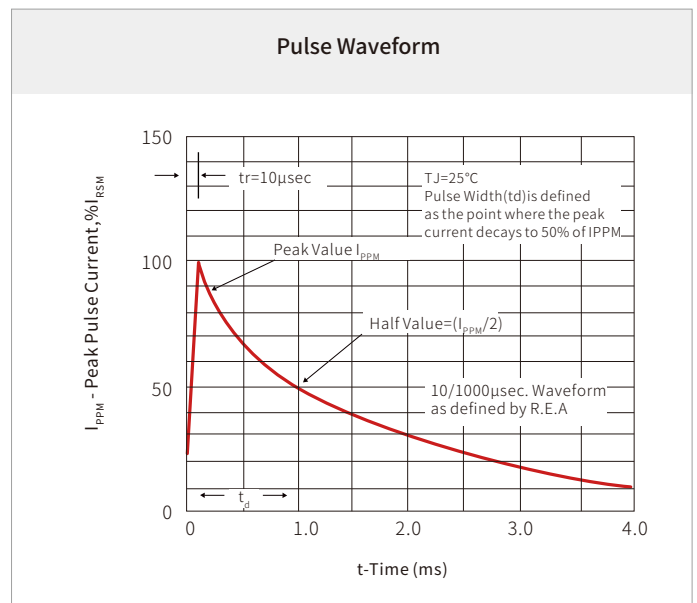
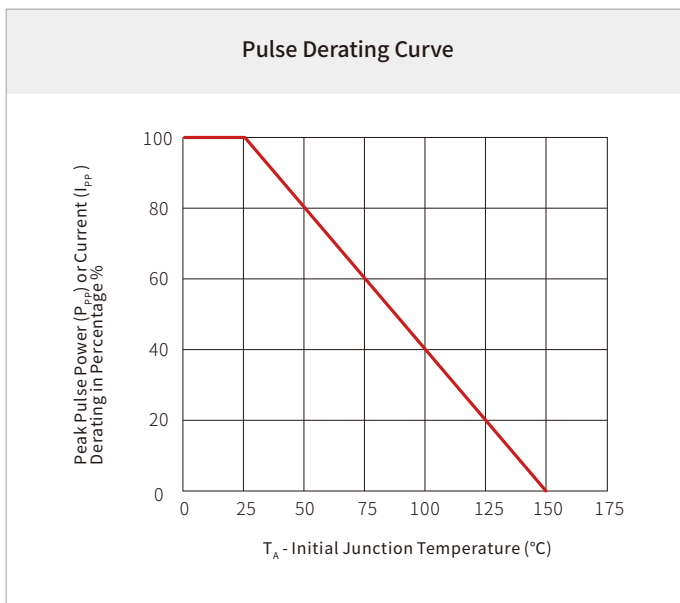
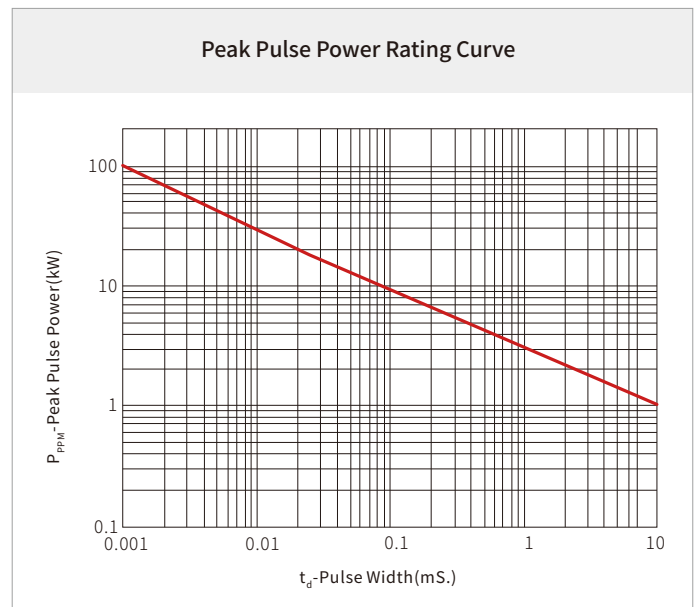
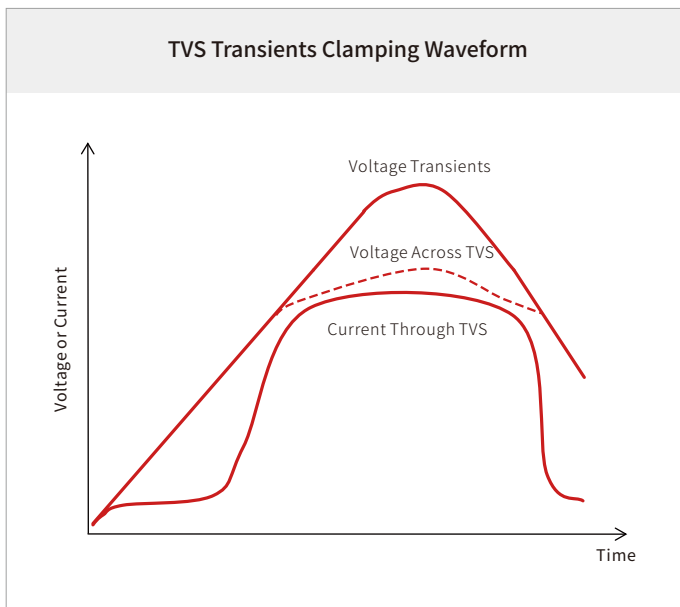

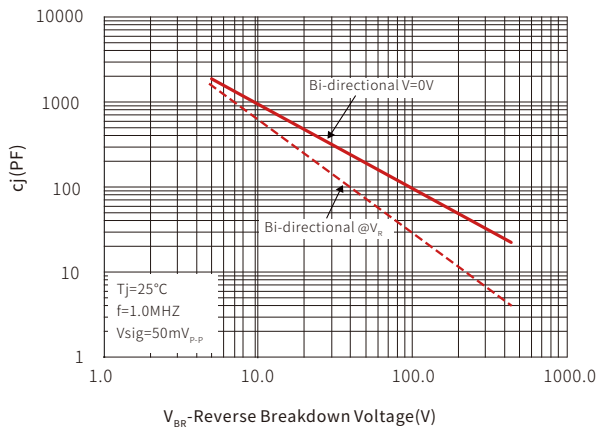
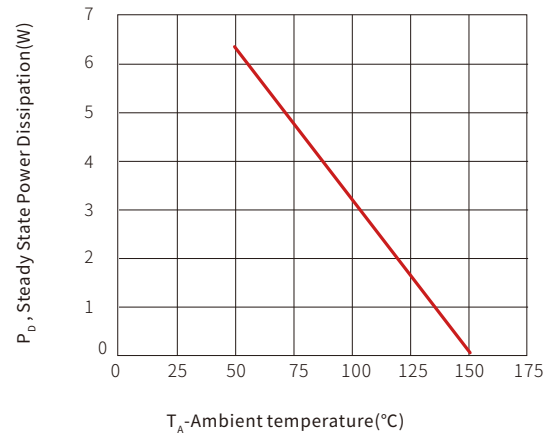
**Typical Junction Capacitance**

**Steady State Power Dissipation Derating Curve**

## SOLDERING PARAMETERS

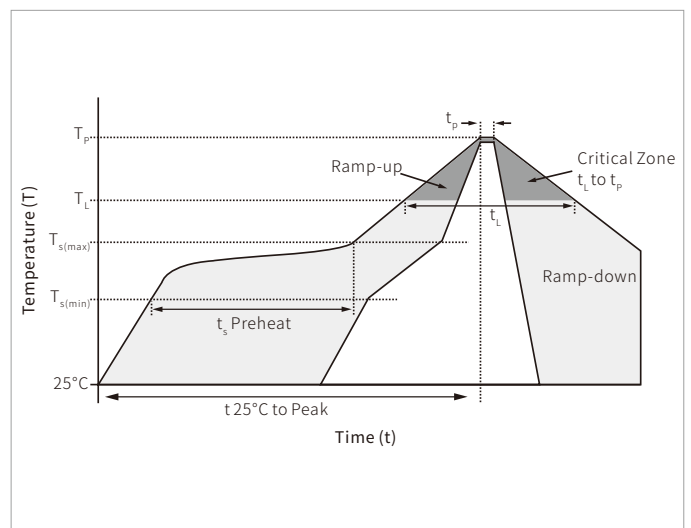
| Reflow Condition                                       |                                  | Lead-free assembly |
|--|----------------------------------|--------------------|
| Pre Heat   | Temperature Max ( $T_{s(min)}$ ) | 150°C              |
|  | Temperature Max ( $T_{s(max)}$ ) | 200°C              |
|  | Time (min to max) ( $t_s$ )      | 60 – 180 secs      |
| Average ramp up rate (Liquidus Temp ( $T_L$ ) to peak) |                                  | 3°C/second max     |
| $T_{s(max)}$ to $T_L$ - Ramp-up Rate                   |                                  | 3°C/second max     |
| Reflow   | Temperature ( $T_L$ ) (Liquidus) | 217°C              |
|  | Time (min to max) ( $t_r$ )      | 60 – 150 seconds   |
| Peak Temperature ( $T_p$ )                             |                                  | 260°C              |
| Time within 5°C of actual peak Temperature ( $t_p$ )   |                                  | 20 – 40 seconds    |
| Ramp-down Rate   |                                  | 6°C/second max     |
| Time 25°C to peak Temperature ( $T_p$ )                |                                  | 8 minutes max.     |
| Do not exceed  |                                  | 260°C              |

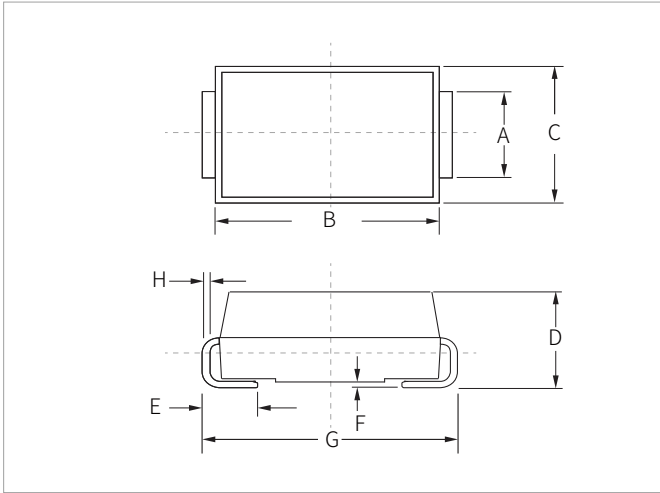

## DO-214AB(SMC) PACKAGE INFORMATION



| Ref. | Millimeters |      | Inches |       |
|------|-------------|------|--------|-------|
|      | Min.        | Max. | Min.   | Max.  |
| A    | 2.80        | 3.20 | 0.110  | 0.126 |
| B    | 6.60        | 7.20 | 0.260  | 0.283 |
| C    | 5.70        | 6.10 | 0.224  | 0.240 |
| D    | 2.15        | 2.75 | 0.085  | 0.108 |
| E    | 1.00        | 1.60 | 0.039  | 0.063 |
| F    | 0.02        | 0.20 | 0.000  | 0.008 |
| G    | 7.60        | 8.00 | 0.299  | 0.315 |
| H    | 0.15        | 0.30 | 0.006  | 0.012 |

## RECOMMENDED PAD LAYOUT DIMENSIONS

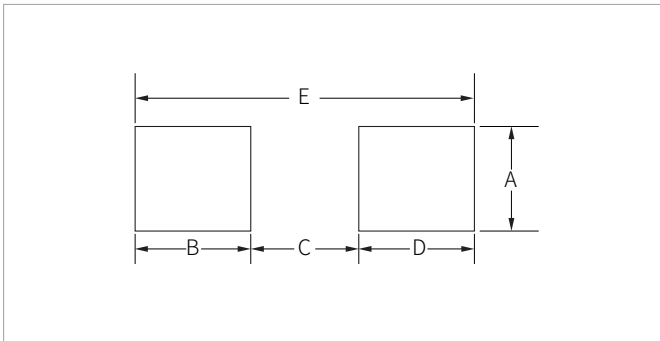

| Ref. | Millimeters |      | Inches   |       |
|------|-------------|------|----------|-------|
|      | Min.        | Max. | Min.     | Max.  |
| A    | 3.30        | -    | 0.129    | -     |
| B    | 2.40        | -    | 0.094    | -     |
| C    | -           | 4.20 | -        | 0.165 |
| D    | 2.40        | -    | 0.094    | -     |
| E    | 8.20REF     |      | 0.323REF |       |

## ORDERING INFORMATION

| Part Number | Component Package | QTY/Reel | Reel Size |
|-------------|-------------------|----------|-----------|
| SVC300B100  | DO-214AB(SMC)     | 3000PCS  | 13"       |

**Headquarters**

No.3387 Shendu Road  
Pujiang I&E Park  
Minhang Shanghai China  
201000

**Hotline**

400-021-5756

**Web**

<https://www.semiware.com>

**Sales Center**

Tel: 86-21-3463-7458  
Email: [sales18@semiware.com](mailto:sales18@semiware.com)

**Customer Service**

Tel: 86-21-5484-1001  
Email: [sales17@semiware.com](mailto:sales17@semiware.com)

**Technical Support**

Tel: 86-21-3463-7654  
Email: [fae01@semiware.com](mailto:fae01@semiware.com)

**Complaint & Suggestions**

Tel: 86-21-3463-7172  
Ext: 8868  
Email: [cs03@semiware.com](mailto:cs03@semiware.com)

**By QR Code**

Website



Wechat

To find your local partner within Semiware' s global website: [www.semiware.com](http://www.semiware.com)

© 2022 Semiware Semiconductor Inc.

The content of this document has been carefully checked and understood. However, neither Semiware nor its subsidiaries assume any liability whatsoever for any errors or inaccuracies of this document and the consequences thereof. Published specifications are subject to change without notice. Product suitability for any area of application must ultimately be determined by the customer. In all cases, products must never be operated outside their published specifications. Semiware does not guarantee the availability of all published products. This disclaimer shall be governed by substantive Chinese law and resulting disputes shall be settled by the courts at the place of business of Semiware. Latest publications and a complete disclaimer can be downloaded from the Semiware website. All trademarks recognized.