

FEATURES

- | Low profile package
- | Ideal for automated placement
- | 5000 Watt peak pulse power capability with a 10/1000µs waveform
- | For surface mounted applications to optimize board space
- | Excellent clamping capability
- | Very fast response time
- | Low incremental surge resistance

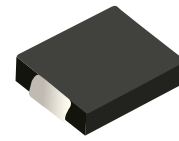

DO-214AB(SMC)

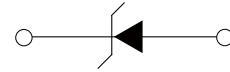

Uni-directional

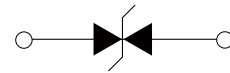

Bi-directional

APPLICATIONS

- | Power supply protection
- | Automotive application
- | Industrial application
- | Power management

APPROVALS

RoHS	Compliance with 2011/65/EU
HF	Compliance with IEC61249-2-21:2003

MAXIMUM RATINGS (T_A=25°C)

Parameter	Symbo	Value	Unit
Peak Pulse Power Dissipation on 10/1000us waveform (Note1, Note2).	P _{PPM}	5000	Watts
Steady State Power Dissipation at T _L =50°C, Lead lengths.375"(9.5mm) (Note2)	P _D	6.5	Watts

- Notes :** 1.Non-repetitive current pulse,T_A=25°C.
 2.Mounted on 5.0mm*5.0mm (0.03mm thick) Copper Pads to each terminal.

THERMAL CONSIDERATIONS

Parameter	Symbol	Value	Unit
Operating Junction Temperature	T _J	-55 to +150	°C
Storage Temperature Range	T _{STG}	-55 to +150	°C
Junction to Ambient on printed circuit	R _{θJA}	75	°C/W

ELECTRICAL CHARACTERISTICS (T_A = 25°C)

Part Number		Device Marking Code		Reverse Stand-off Voltage	Breakdown Voltage Min.@I _T	Breakdown Voltage Max.@I _T	Test Current	Maximum Clamping Voltage @I _{PP}	Peak Pulse Current	Reverse Leakage @V _{RWM}
Uni-Polar	Bi-Polar	Uni	Bi	V _{RWM} (V)	V _{BR} (V)	V _{BR} (V)	I _T (mA)	V _C (V)	I _{PP} (A)	I _R (uA)
5.0SMDJ11A	5.0SMDJ11CA	5PEN	5BEN	11.0	12.20	13.50	10	18.2	275.0	800
5.0SMDJ12A	5.0SMDJ12CA	5PEP	5BEP	12.0	13.20	14.70	10	19.9	252.0	800
5.0SMDJ13A	5.0SMDJ13CA	5PEQ	5BEQ	13.0	14.40	15.90	10	21.5	233.0	500
5.0SMDJ14A	5.0SMDJ14CA	5PER	5BER	14.0	15.60	17.20	10	23.2	216.0	200
5.0SMDJ15A	5.0SMDJ15CA	5PES	5BES	15.0	16.70	18.50	1	24.4	205.0	100
5.0SMDJ16A	5.0SMDJ16CA	5PET	5BET	16.0	17.80	19.70	1	26.0	193.0	50
5.0SMDJ17A	5.0SMDJ17CA	5PEU	5BEU	17.0	18.90	20.90	1	27.6	181.0	20
5.0SMDJ18A	5.0SMDJ18CA	5PEV	5BEV	18.0	20.00	22.10	1	29.2	172.0	10
5.0SMDJ20A	5.0SMDJ20CA	5PEW	5BEW	20.0	22.20	24.50	1	32.4	155.0	5
5.0SMDJ22A	5.0SMDJ22CA	5PEX	5BEX	22.0	24.40	26.90	1	35.5	141.0	5
5.0SMDJ24A	5.0SMDJ24CA	5PEZ	5BEZ	24.0	26.70	29.50	1	38.9	129.0	5
5.0SMDJ26A	5.0SMDJ26CA	5PFE	5BFE	26.0	28.90	31.90	1	42.1	119.0	5
5.0SMDJ28A	5.0SMDJ28CA	5PFG	5BFG	28.0	31.10	34.40	1	45.4	110.0	5
5.0SMDJ30A	5.0SMDJ30CA	5PFK	5BFK	30.0	33.30	36.80	1	48.4	103.0	5
5.0SMDJ33A	5.0SMDJ33CA	5PFM	5BFM	33.0	36.70	40.60	1	53.3	93.9	5
5.0SMDJ36A	5.0SMDJ36CA	5PFP	5BFP	36.0	40.00	44.20	1	58.1	86.1	5
5.0SMDJ40A	5.0SMDJ40CA	5PFR	5BFR	40.0	44.40	49.10	1	64.5	77.6	5
5.0SMDJ43A	5.0SMDJ43CA	5PFT	5BFT	43.0	47.80	52.80	1	69.4	72.1	5
5.0SMDJ45A	5.0SMDJ45CA	5PFV	5BFV	45.0	50.00	55.30	1	72.7	68.8	5
5.0SMDJ48A	5.0SMDJ48CA	5PFX	5BFX	48.0	53.30	58.90	1	77.4	64.7	5
5.0SMDJ51A	5.0SMDJ51CA	5PFZ	5BFZ	51.0	56.70	62.70	1	82.4	60.7	5
5.0SMDJ54A	5.0SMDJ54CA	5PGE	5BGE	54.0	60.00	66.30	1	87.1	57.5	5
5.0SMDJ58A	5.0SMDJ58CA	5PGG	5BGG	58.0	64.40	71.20	1	93.6	53.5	5
5.0SMDJ60A	5.0SMDJ60CA	5PGK	5BGK	60.0	66.70	73.70	1	96.8	51.7	5
5.0SMDJ64A	5.0SMDJ64CA	5PGM	5BGM	64.0	71.10	78.60	1	103.0	48.6	5
5.0SMDJ70A	5.0SMDJ70CA	5PGP	5BGP	70.0	77.80	86.00	1	113.0	44.3	5
5.0SMDJ75A	5.0SMDJ75CA	5PGR	5BGR	75.0	83.30	92.10	1	121.0	41.4	5
5.0SMDJ78A	5.0SMDJ78CA	5PGT	5BGT	78.0	86.70	95.80	1	126.0	39.7	5
5.0SMDJ85A	5.0SMDJ85CA	5PGV	5BGV	85.0	94.40	104.00	1	137.0	36.5	5
5.0SMDJ90A	5.0SMDJ90CA	5PGX	5BGX	90.0	100.00	111.00	1	146.0	34.3	5
5.0SMDJ100A	5.0SMDJ100CA	5PGZ	5BGZ	100.0	111.00	123.00	1	162.0	30.9	5
5.0SMDJ110A	5.0SMDJ110CA	5PHE	5BHE	110.0	122.00	135.00	1	177.0	28.3	5

Part Number		Device Marking Code		Reverse Stand-off Voltage	Breakdown Voltage Min.@I _T	Breakdown Voltage Max.@I _T	Test Current	Maximum Clamping Voltage @I _{pp}	Peak Pulse Current	Reverse Leakage @V _{RWM}
Uni-Polar	Bi-Polar	Uni	Bi	V _{RWM} (V)	V _{BR} (V)	V _{BR} (V)	I _T (mA)	V _C (V)	I _{pp} (A)	I _R (μA)
5.0SMDJ120A	5.0SMDJ120CA	5PHG	5BHG	120.0	133.00	147.00	1	193.0	26.0	5
5.0SMDJ130A	5.0SMDJ130CA	5PHK	5BHK	130.0	144.00	159.00	1	209.0	24.0	5
5.0SMDJ150A	5.0SMDJ150CA	5PHM	5BHM	150.0	155.00	171.00	1	226.8	22.3	5
5.0SMDJ160A	5.0SMDJ160CA	5PHP	5BHP	160.0	167.00	185.00	1	243.0	20.8	5
5.0SMDJ170A	5.0SMDJ170CA	5PHR	5BHR	170.0	178.00	197.00	1	259.0	19.5	5
5.0SMDJ180A	5.0SMDJ180CA	5PHT	5BHT	180.0	189.00	209.00	1	275.0	18.4	5
5.0SMDJ190A	5.0SMDJ190CA	5PHV	5DHV	190.0	200.00	220.00	1	291.6	17.3	5
5.0SMDJ200A	5.0SMDJ200CA	5PHX	5DHX	200.0	211.00	232.00	1	307.8	16.4	5
5.0SMDJ210A	5.0SMDJ210CA	5PHZ	5DHZ	210.0	224.00	247.00	1	324.0	15.6	5
5.0SMDJ220A	5.0SMDJ220CA	5PIE	5DIE	220.0	246.00	272.00	1	356.0	14.2	5
5.0SMDJ250A	5.0SMDJ250CA	5PIG	5DIG	250.0	279.00	309.00	1	405.0	12.5	5
5.0SMDJ300A	5.0SMDJ300CA	5PIK	5DIK	300.0	335.00	371.00	1	486.0	10.4	5
5.0SMDJ350A	5.0SMDJ350CA	5PIM	5DIM	350.0	391.00	432.00	1	567.0	8.9	5
5.0SMDJ400A	5.0SMDJ400CA	5PIP	5DIP	400.0	447.00	494.00	1	648.0	7.8	5

CHARACTERISTIC CURVES

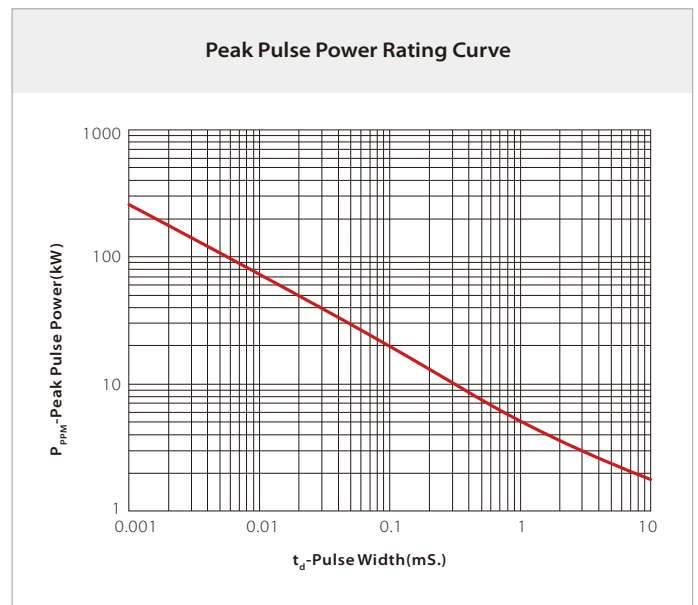
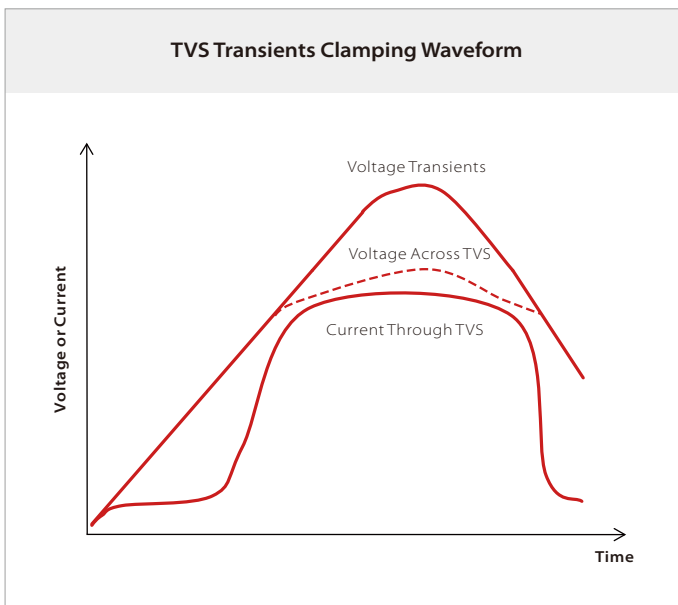

Pulse Derating Curve

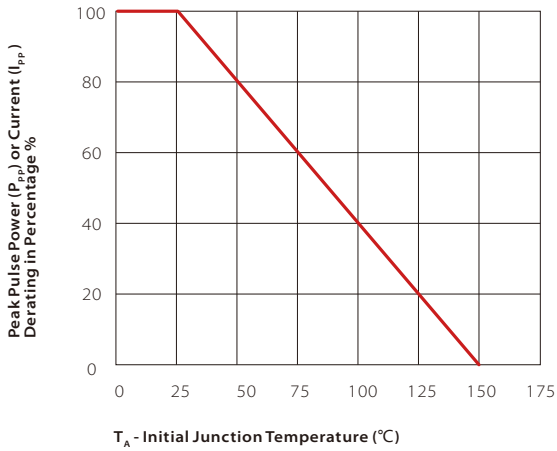

Pulse Waveform

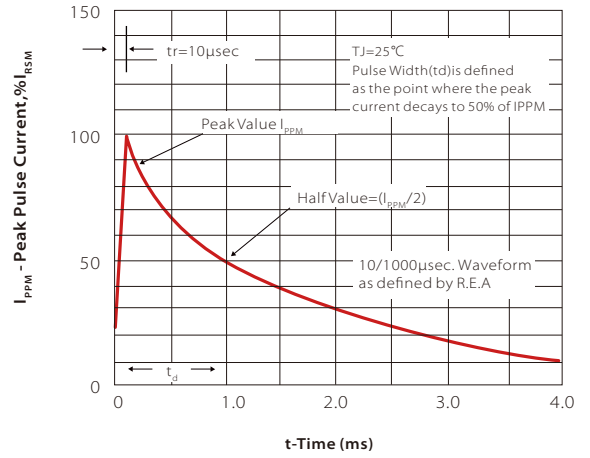

Typical Junction Capacitance

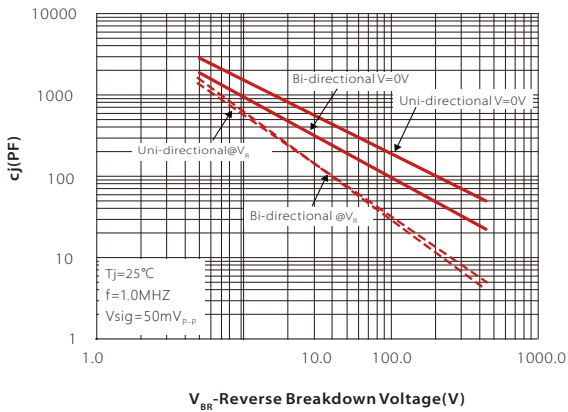

Steady State Power Dissipation Derating Curve

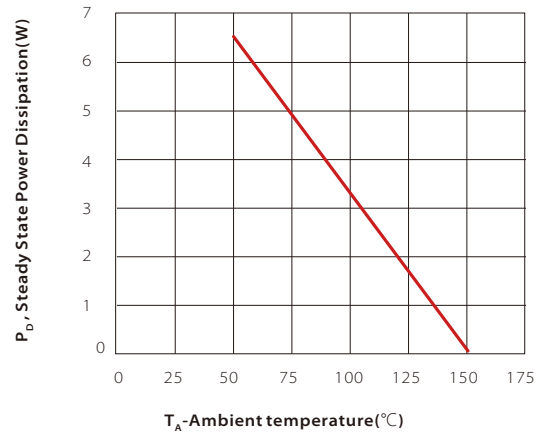

SOLDERING PARAMETERS

Reflow Condition		Lead-free assembly
Pre Heat	Temperature Max ($T_{s(min)}$)	150°C
	Temperature Max ($T_{s(max)}$)	200°C
	Time (min to max) (t_s)	60 – 180 secs
Average ramp up rate (Liquidus Temp (T_L) to peak)		3°C/second max
$T_{s(max)}$ to T_L - Ramp-up Rate		3°C/second max
Reflow	Temperature (T_L) (Liquidus)	217°C
	Time (min to max) (t_r)	60 – 150 seconds
Peak Temperature (T_p)		260°C
Time within 5°C of actual peak Temperature (t_p)		20 – 40 seconds
Ramp-down Rate		6°C/second max
Time 25°C to peak Temperature (T_p)		8 minutes max.
Do not exceed		260°C

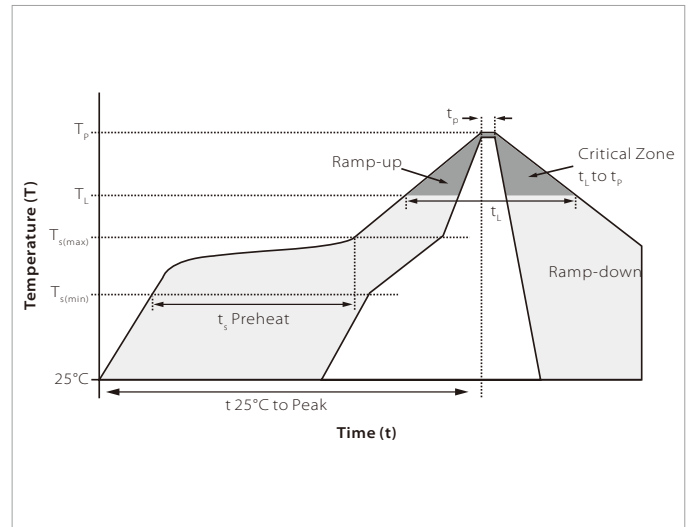

DO-214AB(SMC) PACKAGE INFORMATION

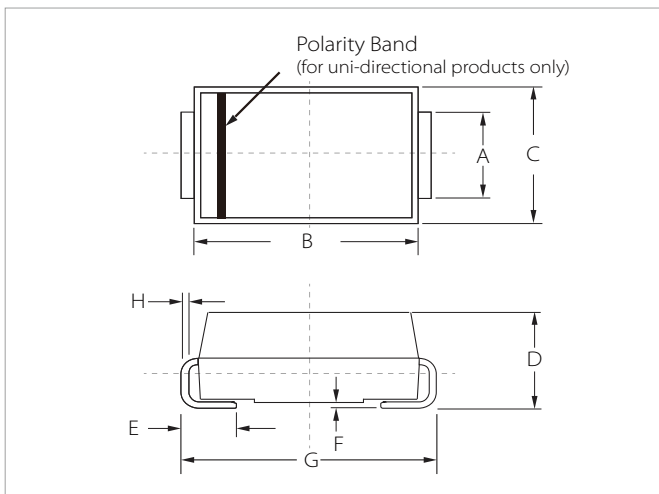

Ref.	Millimeters		Inches	
	Min.	Max.	Min.	Max.
A	2.80	3.20	0.110	0.126
B	6.60	7.20	0.260	0.283
C	5.70	6.10	0.224	0.240
D	2.15	2.75	0.085	0.108
E	1.00	1.60	0.039	0.063
F	0.02	0.20	0.000	0.008
G	7.60	8.00	0.299	0.315
H	0.15	0.30	0.006	0.012

RECOMMENDED PAD LAYOUT DIMENSIONS

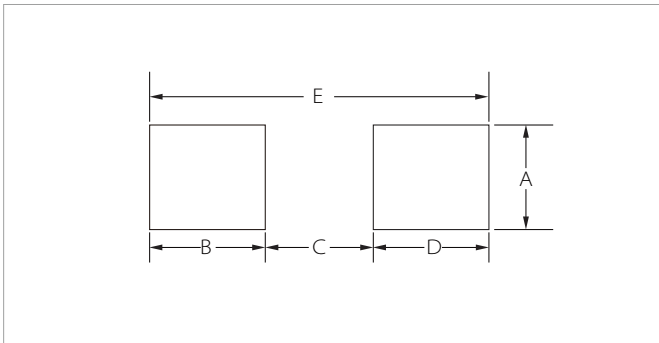

Ref.	Millimeters		Inches	
	Min.	Max.	Min.	Max.
A	3.30	-	0.129	-
B	2.40	-	0.094	-
C	-	4.20	-	0.165
D	2.40	-	0.094	-
E	8.20REF		0.323REF	

ORDERING INFORMATION

Part Number	Component Package	QTY/Reel	Reel Size
5.0SMDJxx(C)A	DO-214AB(SMC)	3000PCS	13"

Headquarters

No.3387 Shendu Road Pujiang
I&E Park
Minhang Shanghai China
201000

Hotline

400-021-5756

Web

<https://www.semiware.com>

Sales Center

Tel: 86-21-3463-7458
Email: sales18@semiware.com

Customer Service

Tel: 86-21-5484-1001
Email: sales17@semiware.com

Technical Support

Tel: 86-21-3463-7654
Email: fae01@semiware.com

Complaint & Suggestions

Tel: 86-21-3463-7172
Ext: 8868
Email: cs03@semiware.com

By QR Code

Website



Wechat

To find your local partner within Semiware's global network: www.semiware.com

© 2022 Semiware Semiconductor Inc.

The content of this document has been carefully checked and understood. However, neither Semiware nor its subsidiaries assume any liability whatsoever for any errors or inaccuracies of this document and the consequences thereof. Published specifications are subject to change without notice. Product suitability for any area of application must ultimately be determined by the customer. In all cases, products must never be operated outside their published specifications. Semiware does not guarantee the availability of all published products. This disclaimer shall be governed by substantive Chinese law and resulting disputes shall be settled by the courts at the place of business of Semiware. Latest publications and a complete disclaimer can be downloaded from the Semiware website. All trademarks recognized.