

FEATURES

- | Complementary to MMBT3904

- | Power Dissipation of 300mW

- | High Stability and High Reliability

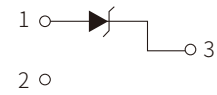

Schematic Symbol

APPROVALS

RoHS	Compliance with 2011/65/EU
HF	Compliance with IEC61249-2-21:2003

MAXIMUM RATINGS ($T_A=25^{\circ}\text{C}$)

Parameter	Symbo	Value	Unit
Power Dissipation	P_D	300	mW
Maximum forward voltage at $I_F=10\text{mA}$	V_F	0.9	V
Thermal Resistance from Junction to Ambient	$R_{\theta JA}$	417	$^{\circ}\text{C}/\text{W}$
Storage temperature range	T_J, T_{STG}	-65 to +150	$^{\circ}\text{C}$

ELECTRICAL CHARACTERISTICS

Part Number	Device Marking Code	Zener Voltage Range				Maximum Zener Impedance			Maximum Reverse Current		Typical temperature coefficient @I _{ZT} mV/°C	
		V _Z @I _{ZT}			I _{ZT}	Z _{ZT} @I _{ZT}	Z _{ZK} @I _{ZK}		I _R	V _R	Min	Max
		Nom(V)	Min(V)	Max(V)	(mA)	(Ω)	(mA)	(μA)	(V)			
BZX84C2V4	Z11	2.4	2.20	2.60	5	100	600	1.0	50	1.0	-3.5	0
BZX84C2V7	Z12	2.7	2.5	2.9	5	100	600	1.0	20	1.0	-3.5	0
BZX84C3V0	Z13	3.0	2.8	3.2	5	95	600	1.0	10	1.0	-3.5	0
BZX84C3V3	Z14	3.3	3.1	3.5	5	95	600	1.0	5	1.0	-3.5	0
BZX84C3V6	Z15	3.6	3.4	3.8	5	90	600	1.0	5	1.0	-3.5	0
BZX84C3V9	Z16	3.9	3.7	4.1	5	90	600	1.0	3	1.0	-3.5	0
BZX84C4V3	Z17	4.3	4.0	4.6	5	90	600	1.0	3	1.0	-3.5	0
BZX84C4V7	Z1	4.7	4.4	5.0	5	80	500	1.0	3	2.0	-3.5	0.2
BZX84C5V1	Z2	5.1	4.8	5.4	5	60	480	1.0	2	2.0	-2.7	1.2
BZX84C5V6	Z3	5.6	5.2	6.0	5	40	400	1.0	1	2.0	-2.0	2.5
BZX84C6V2	Z4	6.2	5.8	6.6	5	10	150	1.0	3	4.0	0.4	3.7
BZX84C6V8	Z5	6.8	6.4	7.2	5	15	80	1.0	2	4.0	1.2	4.5
BZX84C7V5	Z6	7.5	7.0	7.9	5	15	80	1.0	1	5.0	2.5	5.3
BZX84C8V2	Z7	8.2	7.7	8.7	5	15	80	1.0	0.7	5.0	3.2	6.2
BZX84C9V1	Z8	9.1	8.5	9.6	5	15	100	1.0	0.5	6.0	3.8	7.0
BZX84C10	Z9	10	9.4	10.6	5	20	150	1.0	0.2	7.0	4.5	8.0
BZX84C11	Y1•	11	10.4	11.6	5	20	150	1.0	0.1	8.0	5.4	9.0
BZX84C12	Y2•	12	11.4	12.7	5	25	150	1.0	0.1	8.0	6.0	10.0
BZX84C13	Y3	13	12.4	14.1	5	30	170	1.0	0.1	8.0	7.0	11.0
BZX84C15	Y4	15	13.8	15.6	5	30	200	1.0	0.1	10.5	9.2	13.0
BZX84C16	Y5	16	15.3	17.1	5	40	200	1.0	0.1	11.2	10.4	14.0
BZX84C18	Y6•	18	16.8	19.1	5	45	225	1.0	0.1	12.6	12.4	16.0
BZX84C20	Y7	20	18.8	21.2	5	55	225	1.0	0.1	14.0	14.4	18.0
BZX84C22	Y8	22	20.8	23.3	5	55	250	1.0	0.1	15.4	16.4	20.0
BZX84C24	Y9	24	22.8	25.6	5	70	250	1.0	0.1	16.8	18.4	22.0
BZX84C27	Y10	27	25.1	28.9	2	80	300	0.5	0.1	18.9	21.4	25.3
BZX84C30	Y11•	30	28.0	32.0	2	80	300	0.5	0.1	21.0	24.4	29.4
BZX84C33	Y12	33	31.0	35.0	2	80	325	0.5	0.1	23.1	27.1	33.4
BZX84C36	Y13	36	34.0	38.0	2	90	350	0.5	0.1	25.2	30.4	37.4
BZX84C39	Y14	39	37.0	41.0	2	130	350	0.5	0.1	27.3	33.4	41.2
BZX84C43	Y15	43	40.0	46.0	2	100	700	1.0	0.1	32.0	10.0	12.0
BZX84C47	Y16	47	44.0	50.0	2	100	750	1.0	0.1	35.0	10.0	12.0
BZX84C51	Y17	51	48.0	54.0	2	125	750	1.0	0.1	38.0	10.0	12.0

Part Number	Device Marking Code	Zener Voltage Range				Maximum Zener Impedance			Maximum Reverse Current		Typical temperature coefficient @ I_{ZT} mV/°C	
		$V_z@I_{ZT}$			I_{ZT}	$Z_{ZT}@I_{ZT}$	$Z_{ZK}@I_{ZK}$		I_R	V_R	Min	Max
		Nom(V)	Min(V)	Max(V)	(mA)	(Ω)	(mA)	(μ A)	(V)			
BZX84C56	Y18	56.0	52.0	60.0	2	135	700	1.0	0.1	39.0	10.0	12.0
BZX84C62	Y19	62.0	58.0	66.0	2	200	1000	1.0	0.2	47.0	10.0	12.0
BZX84C68	Y20	68.0	64.0	72.0	2	250	1000	1.0	0.2	52.0	10.0	12.0
BZX84C75	Y21	75.0	70.0	79.0	2	300	1000	1.0	0.2	57.0	10.0	12.0

CHARACTERISTIC CURVES

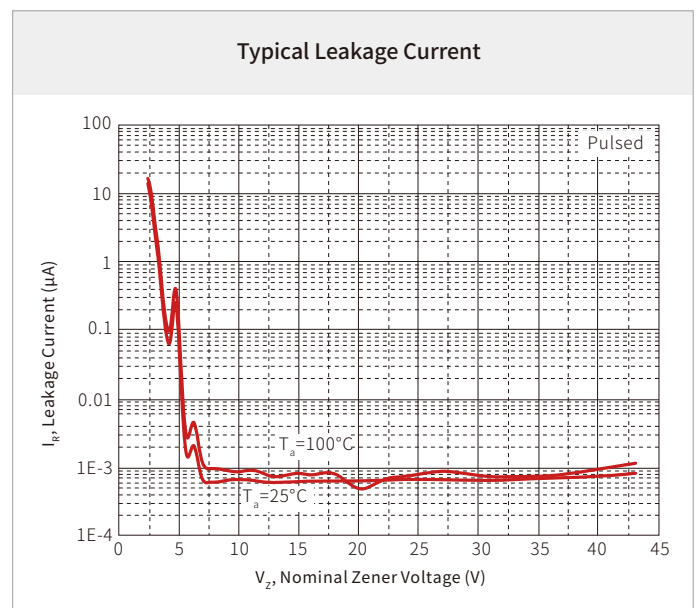
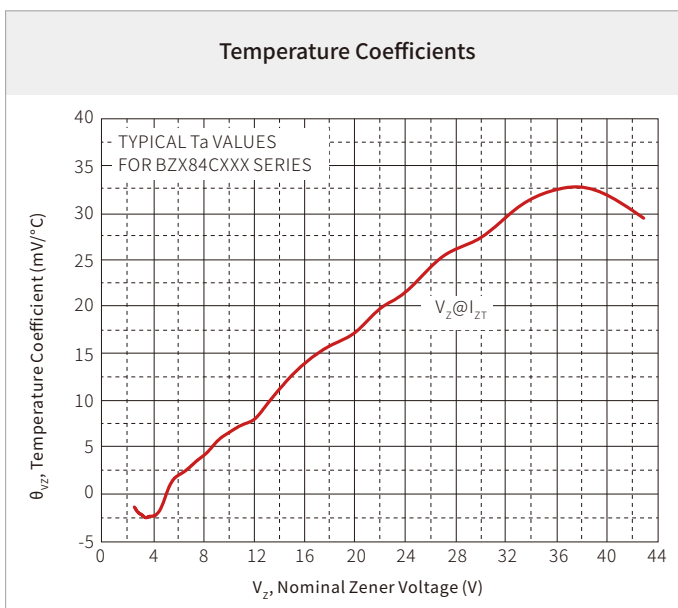
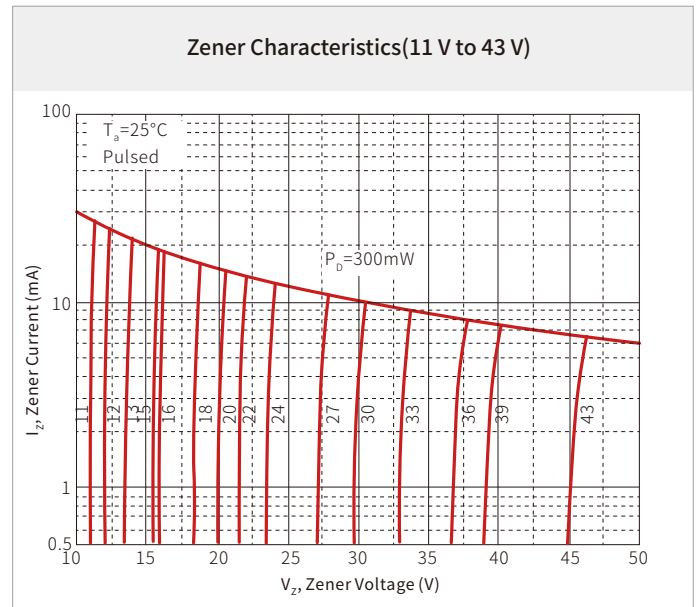
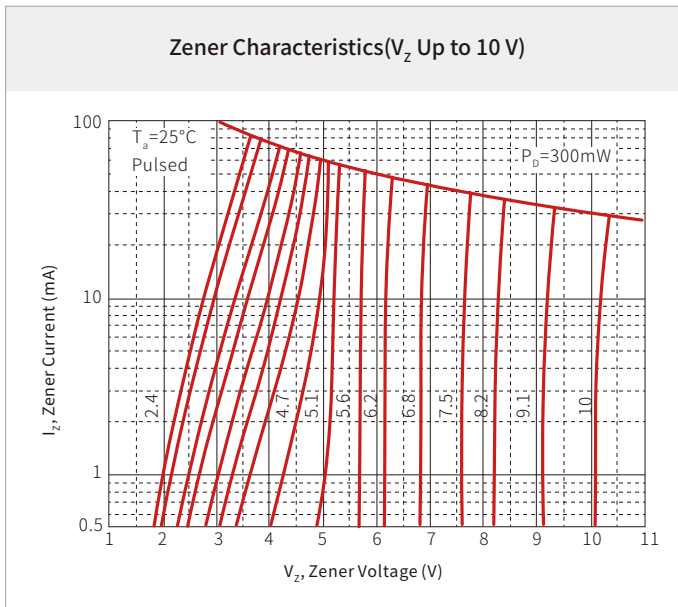

Typical Capacitance

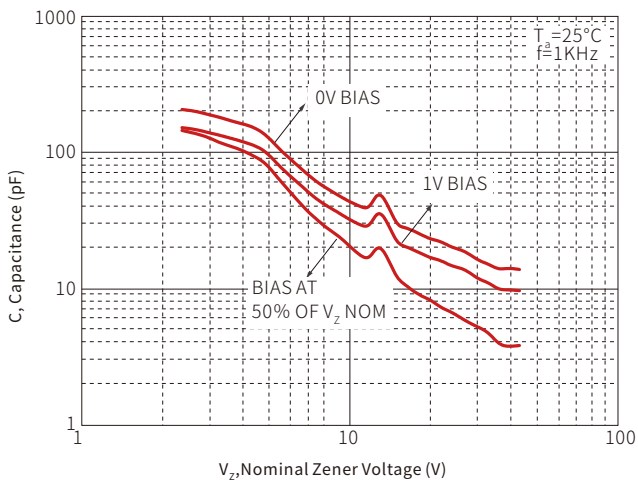

Effect of Zener Voltage on Zener Impedance

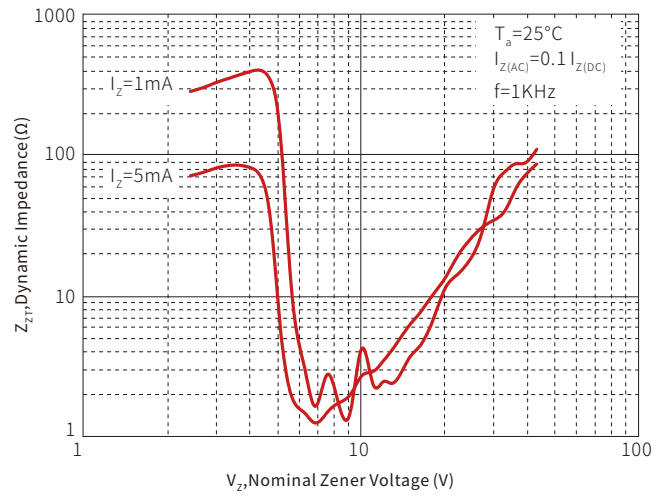

Power Derating Curve

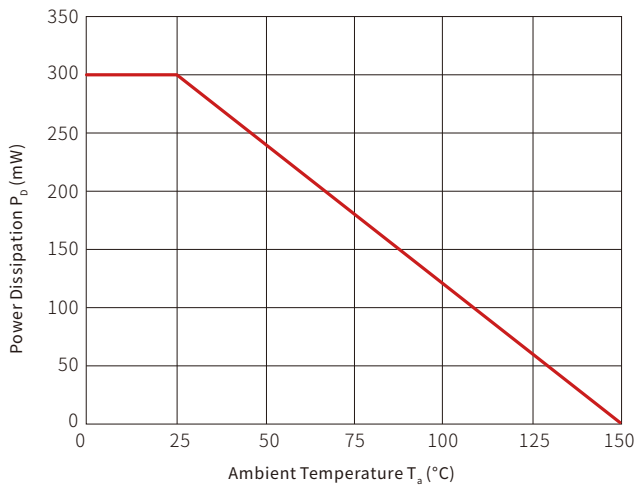

SOLDERING PARAMETERS

Reflow Condition		Lead-free assembly
Pre Heat	Temperature Max ($T_{s(min)}$)	150°C
	Temperature Max ($T_{s(max)}$)	200°C
	Time (min to max) (t_s)	60 – 180 secs
Average ramp up rate (Liquidus Temp (T_L) to peak)		3°C/second max
$T_{s(max)}$ to T_L - Ramp-up Rate		3°C/second max
Reflow	Temperature (T_L) (Liquidus)	217°C
	Time (min to max) (t_L)	60 – 150 seconds
Peak Temperature (T_p)		260°C
Time within 5°C of actual peak Temperature (t_p)		20 – 40 seconds
Ramp-down Rate		6°C/second max
Time 25°C to peak Temperature (T_p)		8 minutes max.
Do not exceed		260°C

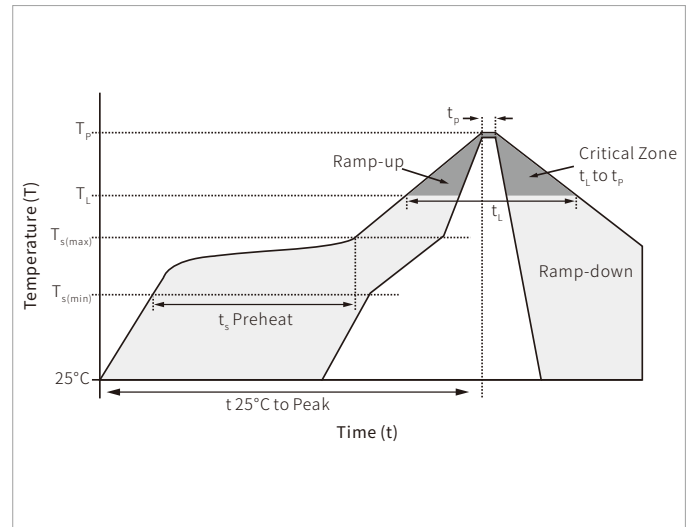

SOT-23 PACKAGE INFORMATION

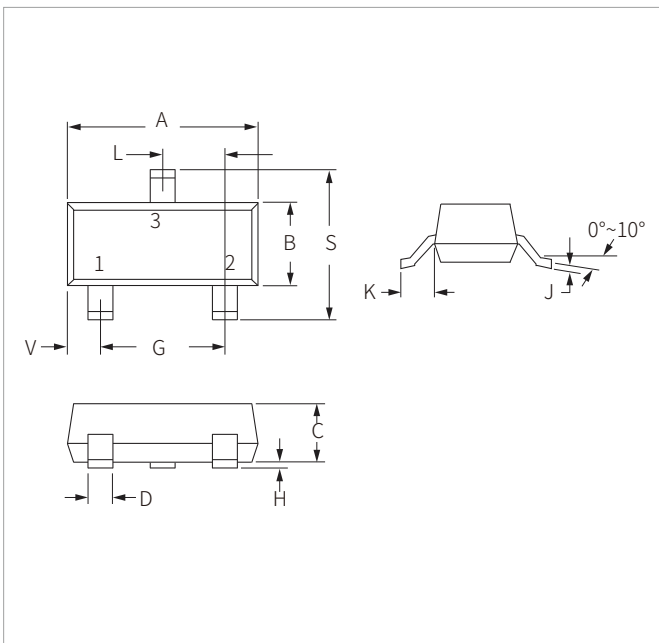

Ref.	Millimeters		Inches	
	Min.	Max.	Min.	Max.
A	2.80	3.05	0.110	0.120
B	1.20	1.40	0.047	0.055
C	0.90	1.15	0.035	0.045
D	0.37	0.50	0.015	0.020
G	1.75	2.05	0.069	0.081
H	0.01	0.100	0.001	0.004
J	0.085	0.180	0.003	0.007
K	0.35	0.69	0.014	0.029
L	0.89	1.02	0.035	0.040
S	2.10	2.65	0.083	0.104
V	0.45	0.60	0.018	0.024

RECOMMENDED PAD LAYOUT DIMENSIONS

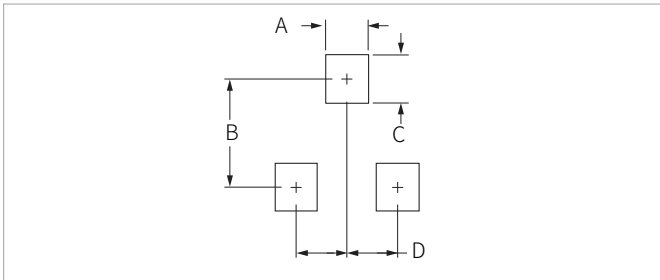

Ref.	Millimeters		Inches	
	Min.	Max.	Min.	Max.
A	0.71	0.97	0.028	0.038
B	1.88	2.13	0.074	0.084
C	0.71	0.97	0.028	0.038
D	0.81	1.07	0.032	0.042

ORDERING INFORMATION

Part Number	Component Package	QTY/Reel	Reel Size
BZX84Cxxx	SOT-23	3000PCS	7"

Headquarters

No.3387 Shendu Road
Pujiang I&E Park
Minhang Shanghai China
201000

Hotline

400-021-5756

Web

<https://www.semiware.com>

Sales Center

Tel: 86-21-3463-7458
Email: sales18@semiware.com

Customer Service

Tel: 86-21-5484-1001
Email: sales17@semiware.com

Technical Support

Tel: 86-21-3463-7654
Email: fae01@semiware.com

Complaint & Suggestions

Tel: 86-21-3463-7172
Ext: 8868
Email: cs03@semiware.com

By QR Code

Website



Wechat

To find your local partner within Semiware' s global website: www.semiware.com

© 2022 Semiware Semiconductor Inc.

The content of this document has been carefully checked and understood. However, neither Semiware nor its subsidiaries assume any liability whatsoever for any errors or inaccuracies of this document and the consequences thereof. Published specifications are subject to change without notice. Product suitability for any area of application must ultimately be determined by the customer. In all cases, products must never be operated outside their published specifications. Semiware does not guarantee the availability of all published products. This disclaimer shall be governed by substantive Chinese law and resulting disputes shall be settled by the courts at the place of business of Semiware. Latest publications and a complete disclaimer can be downloaded from the Semiware website. All trademarks recognized.