

FEATURES

- | Low Forward Voltage Drop

- | Low Reverse Leakage

- | Surface Mount Package Ideally Suited For Automatic Insertion



SOD-123FL

MECHANICAL DATA

- | Encapsulation: SOD-123FL Small Outline Plastic Package

- | Polarity: Color Band Denotes Cathode end

- | Mounting Position: Any

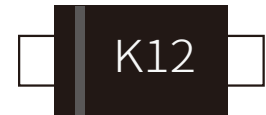

Marking

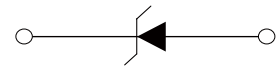

Schematic Symbol

APPROVALS

RoHS	Compliance with 2011/65/EU
HF	Compliance with IEC61249-2-21:2003

MAXIMUM RATINGS (T_A = 25°C)

Parameter	Symbol	Value	Unit	
Maximum Repetitive Peak Reverse Voltage	V _{RRM}	20	V	
Maximum RMS voltage	V _{RMS}	14	V	
Maximum DC Blocking Voltage	V _{DC}	20	V	
Maximum Average Forward Rectified Current at T _L = 100°C	I _{F(AV)}	1.0	A	
Peak Forward Surge Current, 8.3ms Single Half Sine-wave Superimposed on Rated Load (JEDEC method)	I _{FSM}	30	A	
Max Instantaneous Forward Voltage at 1 A	V _F	0.55	V	
Maximum DC Reverse Current at Rated DC Reverse Voltage	I _R	T _a = 25°C	0.2	mA
		T _a = 100°C	20	mA
Typical Thermal Resistance ⁽²⁾	R _{θJA}	85	°C/W	
Operating Junction Temperature Range	T _J	-55 to +125	°C	
Storage Temperature Range	T _{STG}	-55 to +150	°C	

(1) Measured at 1 MHz and applied reverse voltage of 4 V D.C

(2) P.C.B. mounted with 2.0" X 2.0" (5 X 5 cm) copper pad areas.

CHARACTERISTIC CURVES

Fig. 1- Derating Curve Output Rectified Current

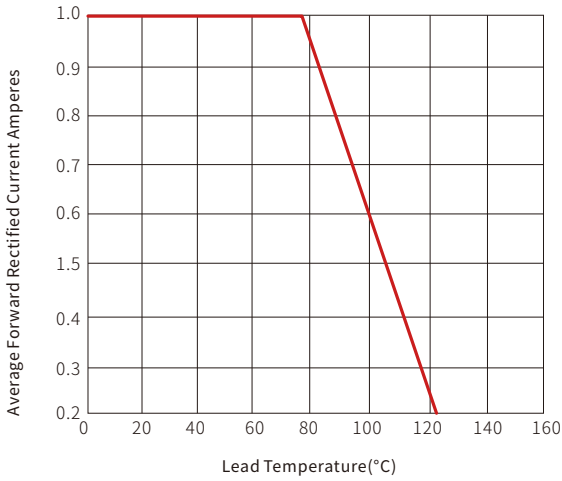

Fig. 2-maximum Non-repetitive Peak Forward Surge Current Perleg

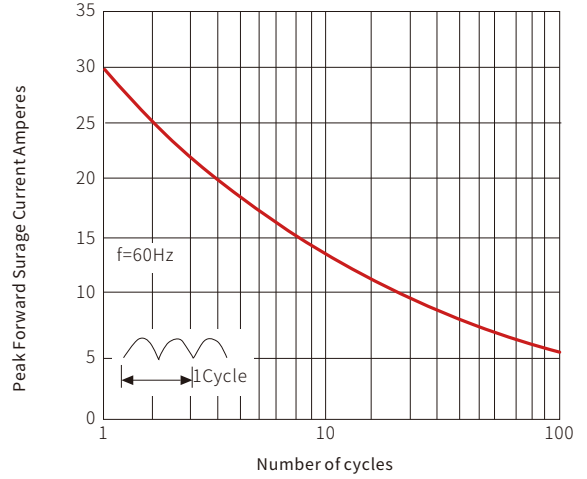

Fig. 3-typical Forward Voltage Characteristics

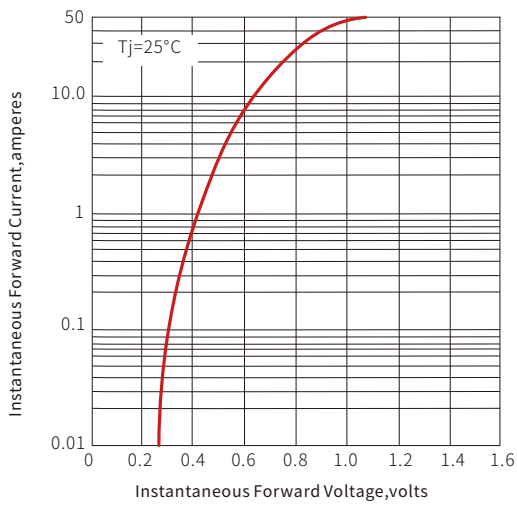
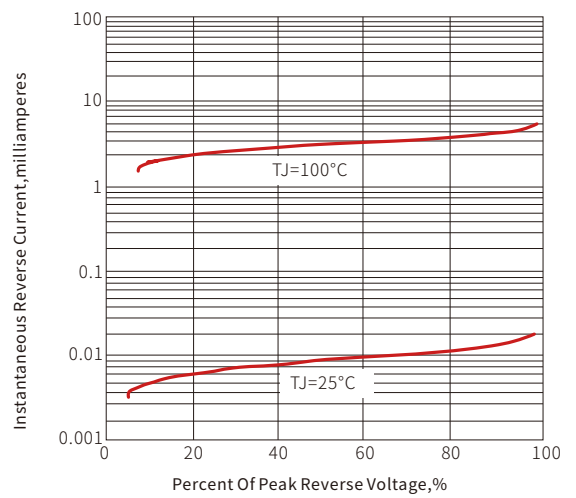
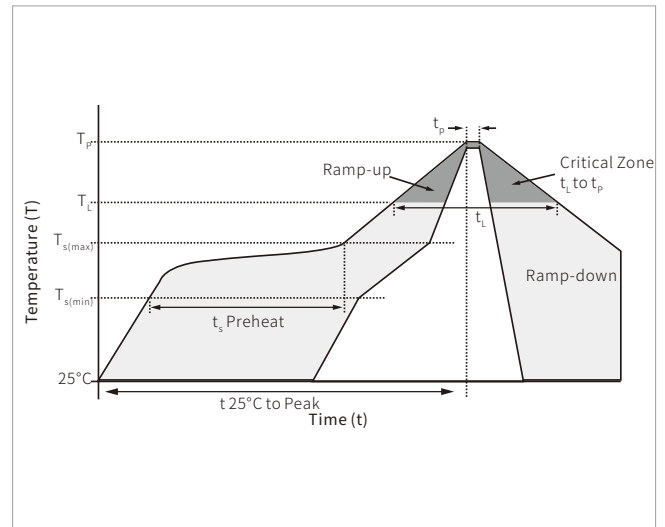

Fig. 4-typical Reverse Leakage Characteristics



SOLDERING PARAMETERS

Reflow Condition		Lead-free assembly
Pre Heat	Temperature Max ($T_{s(min)}$)	150°C
	Temperature Max ($T_{s(max)}$)	200°C
	Time (min to max) (t_s)	60 – 180 secs
Average ramp up rate (Liquidus Temp (T_L) to peak		3°C/second max
$T_{s(max)}$ to T_L - Ramp-up Rate		3°C/second max
Reflow	Temperature (T_L) (Liquidus)	217°C
	Time (min to max) (t_L)	60 – 150 seconds
Peak Temperature (T_p)		260°C
Time within 5°C of actual peak Temperature (t_p)		20 – 40 seconds
Ramp-down Rate		6°C/second max
Time 25°C to peak Temperature (T_p)		8 minutes max.
Do not exceed		260°C



SOD-123FL PACKAGE INFORMATION

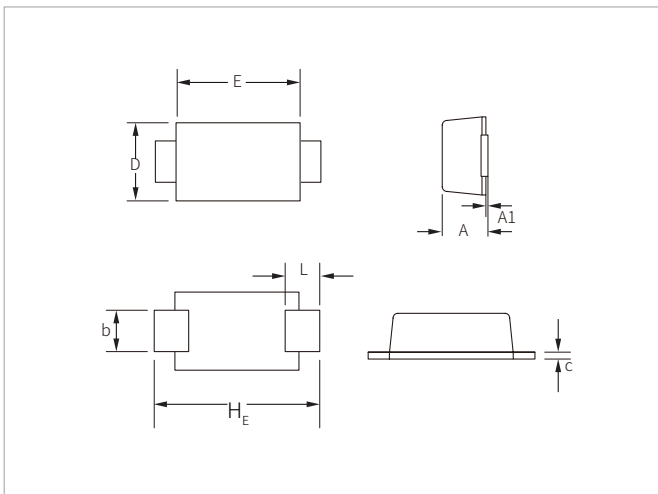

Ref.	Millimeters		Inches	
	Min.	Max.	Min.	Max.
A	0.95	1.45	0.037	0.057
A1	0.00	0.10	0.000	0.004
b	0.70	1.20	0.028	0.047
c	0.05	0.30	0.002	0.012
D	1.50	2.00	0.059	0.079
E	2.50	2.90	0.098	0.114
L	0.35	0.90	0.014	0.035
H_E	3.40	3.90	0.134	0.154

RECOMMENDED PAD LAYOUT DIMENSIONS

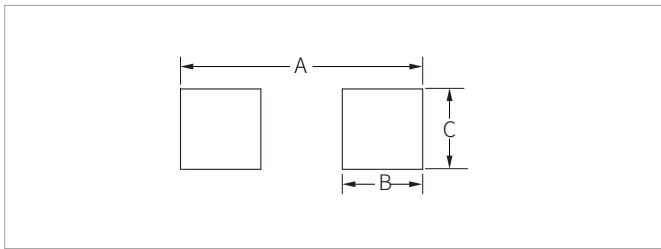

Ref.	Millimeters	Inches
A	4.20	0.165
B	1.50	0.059
C	1.20	0.047

ORDERING INFORMATION

Part Number	Component Package	QTY/Reel	Reel Size
1N5817	SOD-123FL	3000PCS	7"

Headquarters

No.3387 Shendu Road
Pujiang I&E Park
Minhang Shanghai China
201000

Hotline

400-021-5756

Web

<https://www.semiware.com>

Sales Center

Tel: 86-21-3463-7458
Email: sales18@semiware.com

Customer Service

Tel: 86-21-5484-1001
Email: sales17@semiware.com

Technical Support

Tel: 86-21-3463-7654
Email: fae01@semiware.com

Complaint & Suggestions

Tel: 86-21-3463-7172
Ext: 8868
Email: cs03@semiware.com

By QR Code

Website



Wechat

To find your local partner within Semiware's global website: www.semiware.com

© 2022 Semiware Semiconductor Inc.

The content of this document has been carefully checked and understood. However, neither Semiware nor its subsidiaries assume any liability whatsoever for any errors or inaccuracies of this document and the consequences thereof. Published specifications are subject to change without notice. Product suitability for any area of application must ultimately be determined by the customer. In all cases, products must never be operated outside their published specifications. Semiware does not guarantee the availability of all published products. This disclaimer shall be governed by substantive Chinese law and resulting disputes shall be settled by the courts at the place of business of Semiware. Latest publications and a complete disclaimer can be downloaded from the Semiware website. All trademarks recognized.