

FEATURES

- | High Current Capability
- | Low Forward Voltage Drop
- | Extremely Fast Switching Speed
- | Meet AEC-Q101 Requirements



SOT-23



Marking

MECHANICAL DATA

- | SOT-23 Small Outline Plastic Package
- | Epoxy UL: 94V-0
- | Mounting Position: Any

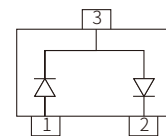

Schematic Symbol

APPROVALS

RoHS	Compliance with 2011/65/EU
HF	Compliance with IEC61249-2-21:2003

MAXIMUM RATINGS ($T_A=25^{\circ}\text{C}$)

Parameter	Symbol	Value	Unit
Maximum Repetitive Peak Reverse Voltage	V_{RRM}	30	V
Maximum RMS Voltage	V_{RMS}	21	V
Maximum DC Blocking Voltage	V_{DC}	30	V
Maximum Average Forward Rectified Current	I_{FM}	200	mA
Peak Forward Surge Current 8.3ms Single Half Sine-wave	I_{FSM}	600	mA
Typical Thermal Resistance	$R_{\theta JA}$	500	$^{\circ}\text{C}/\text{W}$
Power Dissipation	P_D	200	mW
Junction Temperature	T_J	125	$^{\circ}\text{C}$
Storage Temperature Range	T_{stg}	-50~+150	$^{\circ}\text{C}$

ELECTRICAL CHARACTERISTICS(T_A=25°C)

Parameter	Symbol	Test Conditions	Min.	Typ.	Max.	Unit
Forward voltage	V _F	I _F =0.1mA			0.24	V
		I _F =1.0mA			0.32	V
		I _F =10mA			0.40	V
		I _F =30mA			0.50	V
		I _F =100mA			1.00	V
Reverse breakdown voltage	V _(BR)	I _R =100μA	30			V
Reverse Leakage Current	I _R	V _R =25V			2	μA
Type junction capacitance	C _j	V _R =1V, f=1MHz			10	pF
Reverse Recovery Time	T _{RR}	I _F =I _R =10mA, R _L =100Ω I _{RR} =0.1×I _R			5	nS

CHARACTERISTIC CURVES

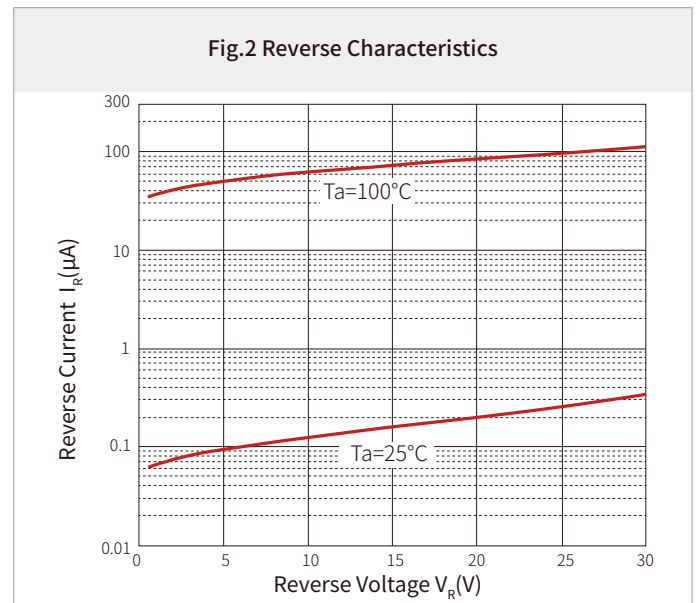
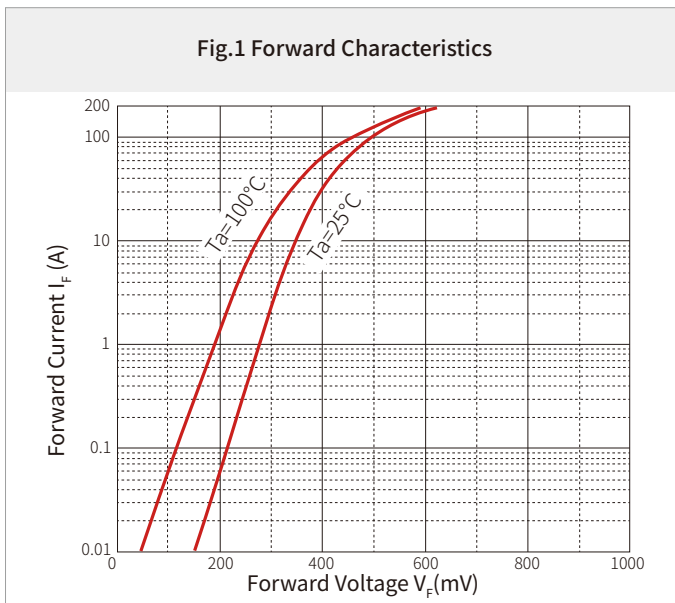
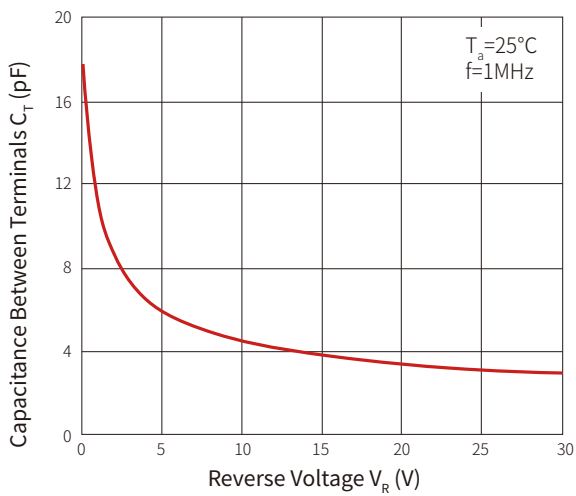
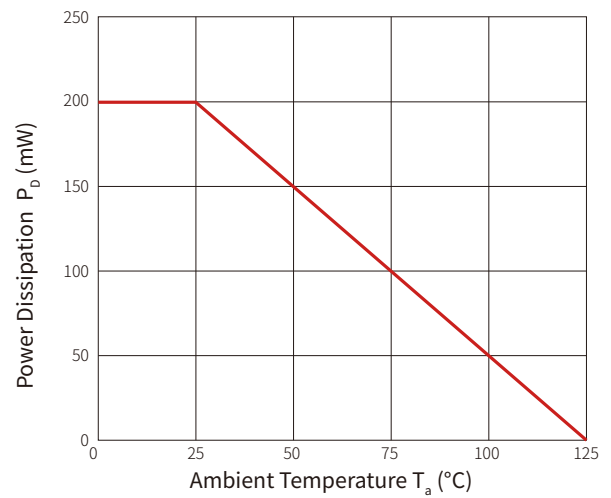
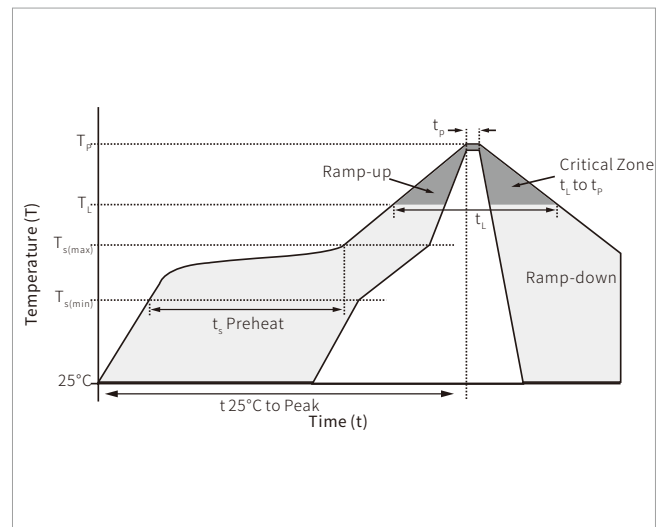

Fig.3 Capacitance Characteristics

Fig.4 Power Derating Curve

SOLDERING PARAMETERS

Reflow Condition		Lead-free assembly
Pre Heat	Temperature Max ($T_{s(\text{min})}$)	150 $^\circ\text{C}$
	Temperature Max ($T_{s(\text{max})}$)	200 $^\circ\text{C}$
	Time (min to max) (t_s)	60 – 180 secs
Average ramp up rate (Liquidus Temp (T_L) to peak)		3 $^\circ\text{C}/\text{second}$ max
$T_{s(\text{max})}$ to T_L - Ramp-up Rate		3 $^\circ\text{C}/\text{second}$ max
Reflow	Temperature (T_L) (Liquidus)	217 $^\circ\text{C}$
	Time (min to max) (t_L)	60 – 150 seconds
Peak Temperature (T_p)		260 $^\circ\text{C}$
Time within 5 $^\circ\text{C}$ of actual peak Temperature (t_p)		20 – 40 seconds
Ramp-down Rate		6 $^\circ\text{C}/\text{second}$ max
Time 25 $^\circ\text{C}$ to peak Temperature (T_p)		8 minutes max.
Do not exceed		260 $^\circ\text{C}$

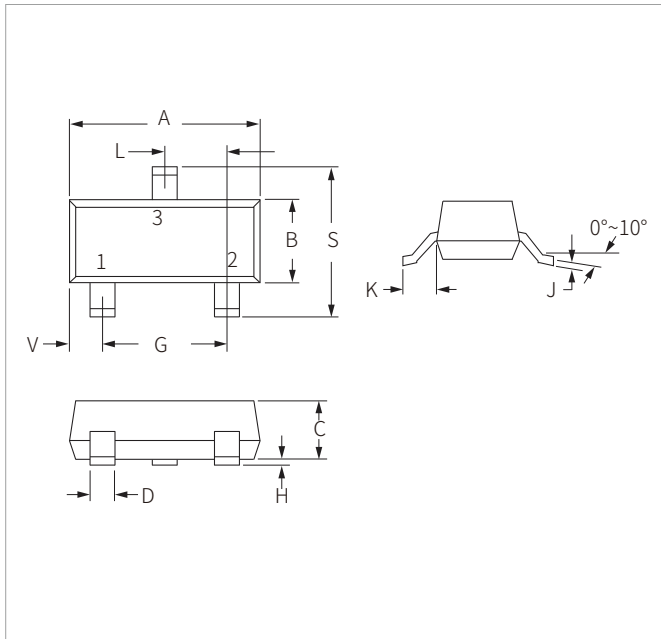

SOT-23 PACKAGE INFORMATION



Ref.	Millimeters		Inches	
	Min.	Max.	Min.	Max.
A	2.80	3.05	0.110	0.120
B	1.20	1.40	0.047	0.055
C	0.90	1.15	0.035	0.045
D	0.37	0.50	0.015	0.020
G	1.75	2.05	0.069	0.081
H	0.01	0.100	0.001	0.004
J	0.085	0.180	0.003	0.007
K	0.35	0.69	0.014	0.029
L	0.89	1.02	0.035	0.040
S	2.10	2.65	0.083	0.104
V	0.45	0.60	0.018	0.024

RECOMMENDED PAD LAYOUT DIMENSIONS

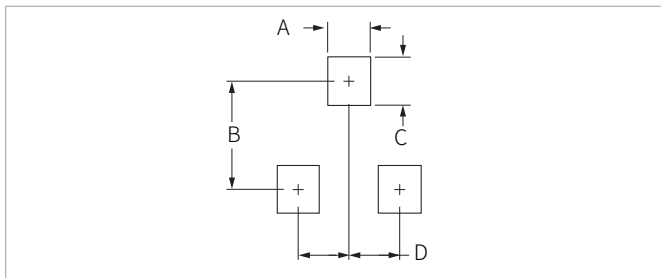

Ref.	Millimeters		Inches	
	Min.	Max.	Min.	Max.
A	0.71	0.97	0.028	0.038
B	1.88	2.13	0.074	0.084
C	0.71	0.97	0.028	0.038
D	0.81	1.07	0.032	0.042

ORDERING INFORMATION

Part Number	Component Package	QTY/Reel	Reel Size
BAT54SQ	SOT-23	3000PCS	7"

Headquarters

No.3387 Shendu Road
Pujiang I&E Park
Minhang Shanghai China
201000

Hotline

400-021-5756

Web

<https://www.semiware.com>

Sales Center

Tel: 86-21-3463-7458
Email: sales18@semiware.com

Customer Service

Tel: 86-21-5484-1001
Email: sales17@semiware.com

Technical Support

Tel: 86-21-3463-7654
Email: fae01@semiware.com

Complaint & Suggestions

Tel: 86-21-3463-7172
Ext: 8868
Email: cs03@semiware.com

By QR Code

Website



Wechat

To find your local partner within Semiware's global website: www.semiware.com

© 2022 Semiware Semiconductor Inc.

The content of this document has been carefully checked and understood. However, neither Semiware nor its subsidiaries assume any liability whatsoever for any errors or inaccuracies of this document and the consequences thereof. Published specifications are subject to change without notice. Product suitability for any area of application must ultimately be determined by the customer. In all cases, products must never be operated outside their published specifications. Semiware does not guarantee the availability of all published products. This disclaimer shall be governed by substantive Chinese law and resulting disputes shall be settled by the courts at the place of business of Semiware. Latest publications and a complete disclaimer can be downloaded from the Semiware website. All trademarks recognized.