

FEATURES

- | Excellent capability of absorbing transient surge
- | Quick response to surge voltage
- | Eliminates over voltage caused by fast rising transients
- | Solid-state silicon technology, non degenerative

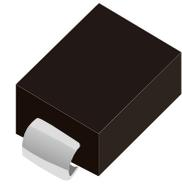

SMB(DO-214AA)

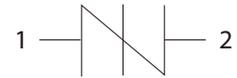

Schematic Symbol

APPLICATIONS

- | Audio/Video line
- | Network and telecom
- | Data lines and security systems
- | Serial ports

APPROVALS

RoHS	Compliance with 2011/65/EU
HF	Compliance with IEC61249-2-21:2003

ELECTRICAL CHARACTERISTICS

Part Number	Marking	V_{DRM}	V_S	V_T	I_{DRM}	I_S	I_T	I_H	C_o
		Min. (V)	Max. (V)	Max. (V)	Max. (μ A)	mA	Max. (A)	Min. (mA)	Typ.(pF)
P0060SA	P006A	6	15	4	5	800	2.2	40	50
P0080SA	P008A	6	25	4	5	800	2.2	40	50
P0150SA	P015A	15	25	4	5	800	2.2	40	50
P0300SA	P03A	25	40	4	5	800	2.2	40	70
P0640SA	P06A	58	77	4	5	800	2.2	120	50
P0720SA	P07A	65	88	4	5	800	2.2	120	50
P0900SA	P09A	75	98	4	5	800	2.2	120	45
P1100SA	P11A	90	130	4	5	800	2.2	120	45
P1300SA	P13A	120	160	4	5	800	2.2	120	45
P1500SA	P15A	140	180	4	5	800	2.2	120	40
P1800SA	P18A	170	220	4	5	800	2.2	120	40
P2300SA	P23A	190	260	4	5	800	2.2	120	35
P2600SA	P26A	220	300	4	5	800	2.2	120	35
P3100SA	P31A	275	350	4	5	800	2.2	120	30
P3500SA	P35A	320	400	4	5	800	2.2	120	30
P4200SA	P42A	400	520	4	5	800	2.2	\leq 50	30

SURGE RATINGS

Part Number	I_{PP} 2x10us	I_{PP} 8x20us	I_{PP} 10x560us	I_{PP} 10x1000us	V_{PP} 10x700us	I_{TSM} 60Hz	d_i/d_t
	(A)	(A)	(A)	(A)	(V)	(A)	(A/us)
P0060SA Thru P4200SA	150	150	100	50	3000	20	500

THERMAL CONSIDERATIONS

Symbol	Parameter	Value	Unit
$R_{\theta JA}$	Junction to Ambient on printed circuit	90	°C/W
T_J	Operating Junction Temperature	-55 to +150	°C
T_{STG}	Storage Temperature Range	-55 to +150	°C

RATINGS AND CHARACTERISTIC CURVES ($T_A=25^\circ\text{C}$)

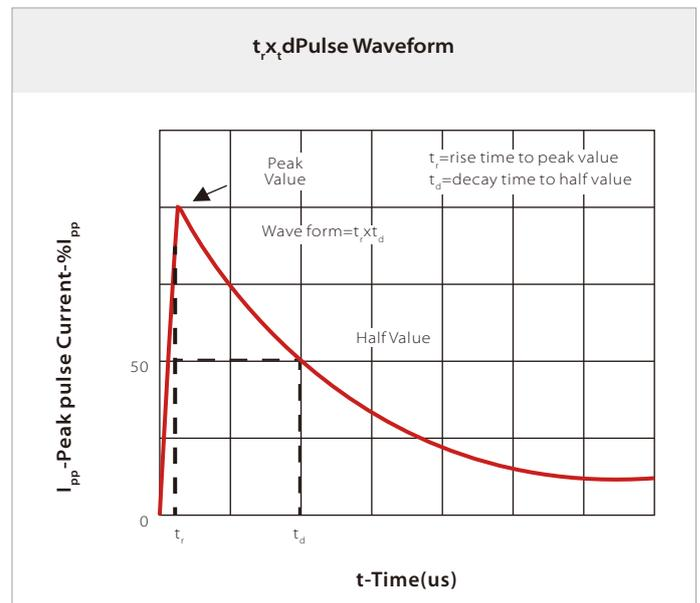
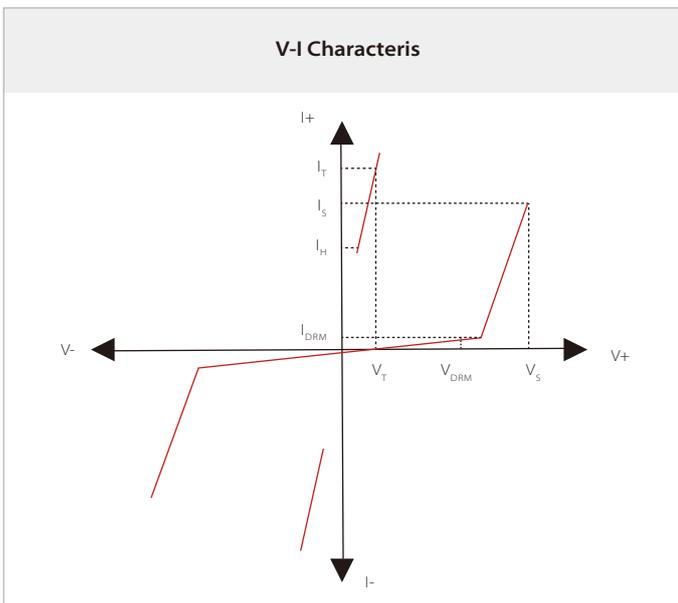

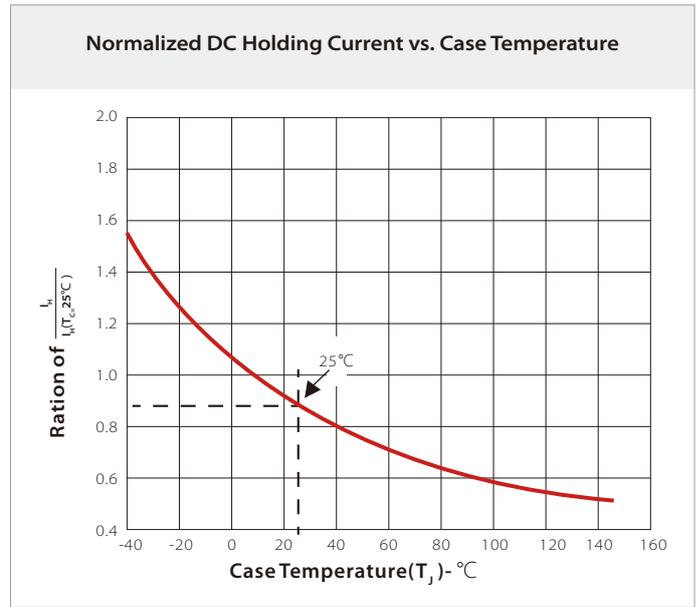
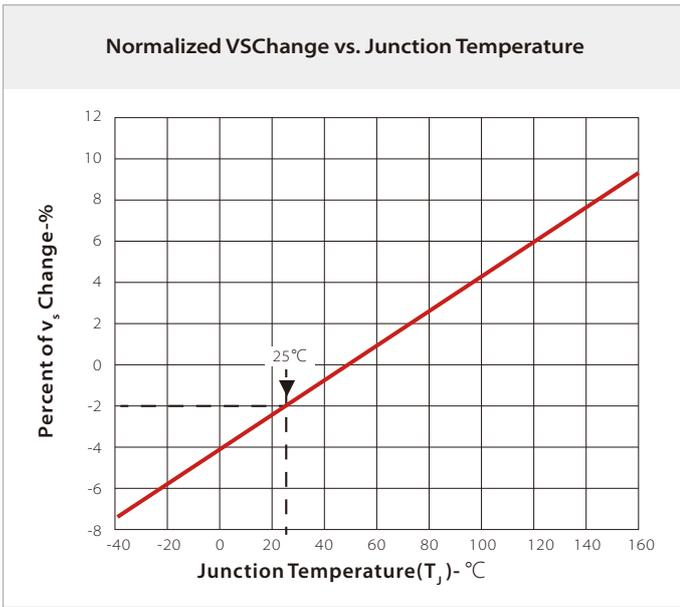

SOLDERING PARAMETERS

Reflow Condition		Lead-free assembly
Pre Heat	Temperature Max ($T_{s(\min)}$)	150°C
	Temperature Max ($T_{s(\max)}$)	200°C
	Time (min to max) (t_s)	60 – 180 secs
Average ramp up rate (Liquidus Temp (T_L) to peak)		3°C/second max
$T_{s(\max)}$ to T_L - Ramp-up Rate		3°C/second max
Reflow	Temperature (T_L) (Liquidus)	217°C
	Time (min to max) (t_r)	60 – 150 seconds
Peak Temperature (T_p)		260°C
Time within 5°C of actual peak Temperature (t_p)		20 – 40 seconds
Ramp-down Rate		6°C/second max
Time 25°C to peak Temperature (T_p)		8 minutes max.
Do not exceed		260°C

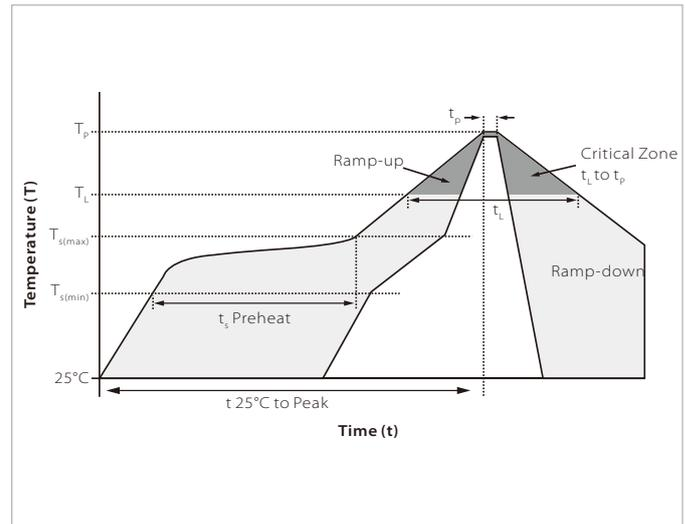

DO-214AA(SMB) PACKAGE INFORMATION

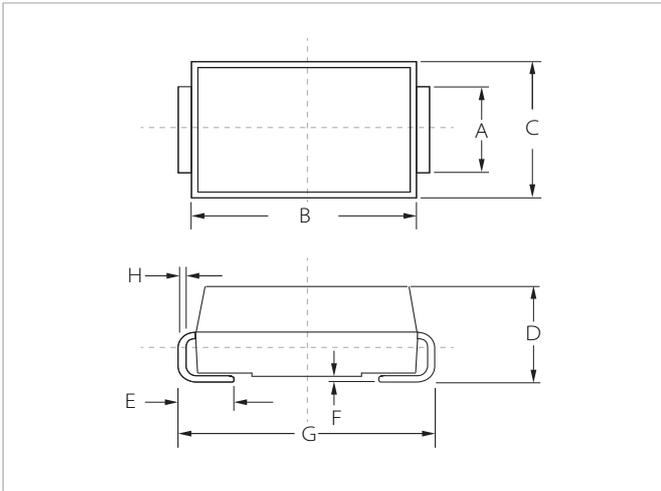

Ref.	Millimeters		Inches	
	Min.	Max.	Min.	Max.
A	1.80	2.20	0.071	0.087
B	4.30	4.70	0.170	0.185
C	3.40	3.90	0.134	0.153
D	2.15	2.55	0.085	0.100
E	1.00	1.50	0.039	0.059
F	0.02	0.20	0.001	0.008
G	5.10	5.50	0.200	0.216
H	0.15	0.30	0.006	0.012

RECOMMENDED PAD LAYOUT DIMENSIONS

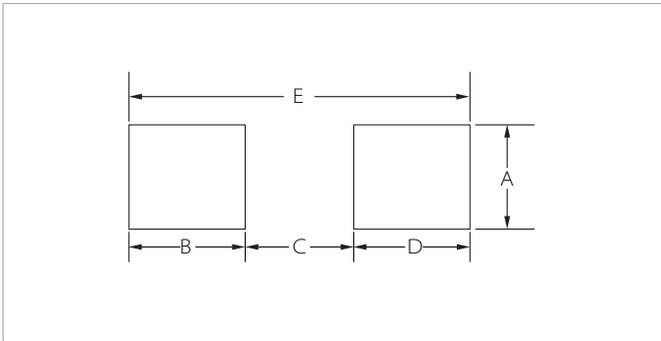

Ref.	Millimeters		Inches	
	Min.	Max.	Min.	Max.
A	2.20	-	0.087	-
B	1.45	-	0.057	-
C	-	2.55	-	0.010
D	1.45	-	0.057	-
E	5.60REF		0.220REF	

ORDERING INFORMATION

Part Number	Component Package	QTY/Reel	Reel Size
PxxxxSA	DO-214AA(SMB)	3000PCS	13"

Headquarters

No.3387 Shendu Road Pujiang
I&E Park
Minhang Shanghai China
201000

Hotline

400-021-5756

Web

<https://www.semiware.com>

Sales Center

Tel: 86-21-3463-7458
Email: sales18@semiware.com

Customer Service

Tel: 86-21-5484-1001
Email: sales17@semiware.com

Technical Support

Tel: 86-21-3463-7654
Email: fae01@semiware.com

Complaint & Suggestions

Tel: 86-21-3463-7172
Ext: 8868
Email: cs03@semiware.com

By QR Code

Website



Wechat

To find your local partner within Semiware's global network: www.semiware.com

© 2022 Semiware Semiconductor Inc.

The content of this document has been carefully checked and understood. However, neither Semiware nor its subsidiaries assume any liability whatsoever for any errors or inaccuracies of this document and the consequences thereof. Published specifications are subject to change without notice. Product suitability for any area of application must ultimately be determined by the customer. In all cases, products must never be operated outside their published specifications. Semiware does not guarantee the availability of all published products. This disclaimer shall be governed by substantive Chinese law and resulting disputes shall be settled by the courts at the place of business of Semiware. Latest publications and a complete disclaimer can be downloaded from the Semiware website. All trademarks recognized.