

FEATURES

- | Low $R_{DS(on)}$ Provides Higher Efficiency and Extends Battery Life
- | Excellent ON resistance for higher DC current :
 $R_{DS(ON)} < 42m\ \Omega$ @ $V_{GS} = -4.5V$ (Type:32m Ω)
- | $V_{DS} = -20V, I_D = -4.1A$
- | Supper high density cell design
- | High performance trench technology
- | High Power and current handing capability
- | Surface Mount Package

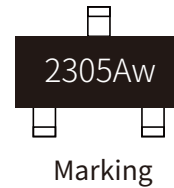

APPLICATION

- | Load/Power Switching for portable device
- | Charging device
- | Power supply converters circuit

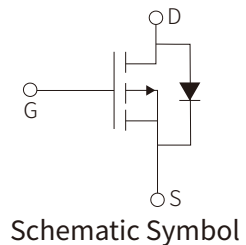

APPROVALS

RoHS	Compliance with 2011/65/EU
HF	Compliance with IEC61249-2-21:2003

ABSOLUTE MAXIMUM RATINGS

Parameter	Symbol	Value	Unit
Drain Source Voltage	V_{DSS}	-20	V
Gate Source Voltage	V_{GSS}	± 12	V
Continuous Drain Current ($T_c=25^\circ C$)	I_D	-4.1	A
Power Dissipation ($T_c=25^\circ C$)	P_D	1.7	W
Junction-to-Ambient Thermal Resistance ^a	$R_{\theta JA}$	75	$^\circ C/W$
Operating Junction and Storage Temperature Range	T_J, T_{STG}	-55 to 150	$^\circ C$

^a Surface mounted on FR-5 Board using 1 square inch pad size, 1oz copper

ELECTRICAL CHARACTERISTICS (Ta=25°C)

Parameter	Symbol	Test Conditions	Min	Typ	Max	Unit
Static Characteristics						
Drain Source Breakdown Voltage	BV_{DSS}	$V_{GS}=0V, I_D=-250\mu A$	-20			V
Gate Leakage Current	I_{GSS}	$V_{GS}=\pm 12V, V_{DS}=0V$			± 0.1	μA
Drain Cut-Off Current	I_{DSS}	$V_{DS}=-20V, V_{GS}=0V$			-1	μA
Gate Threshold Voltage	$V_{GS(th)}$	$V_{DS}=V_{GS}, I_D=-250\mu A$	-0.45	-0.70	-1.0	V
Drain-Source On-State Resistance	$R_{DS(on)}$	$V_{GS}=-4.5V, I_D=-4.1A$		32	42	$m\Omega$
		$V_{GS}=-2.5V, I_D=-3A$		50	75	$m\Omega$
Forward Trans conductance	g_{FS}	$V_{DS}=-5V, I_D=-2A$	6			S
Dynamic Characteristics						
Input Capacitance	C_{iss}	$V_{DS}=-4V, V_{GS}=0V, f=1.0MHz$		740		pF
Output Capacitance	C_{oss}			290		pF
Reverse Transfer Capacitance	C_{rss}			190		pF
Turn-on Delay Time	$t_{d(on)}$	$V_{DD}=-4V, I_D=-3.3A$ $V_{GEN}=-4.5V, R_G=1\Omega$ $R_L=1.2\Omega$			15	ns
Turn-on Rise Time	t_r				80	ns
Turn-Off Delay Time	$t_{d(off)}$				60	ns
Turn-off Fall Time	t_f				25	ns
Total Gate Charge	Q_g	$V_{DS}=-10V, I_D=-4.1A$ $V_{GS}=-4.5V$		7.8		nC
Gate-Source Charge	Q_{gs}			1.2		nC
Gate-Drain Charge	Q_{gd}			1.6		nC
Drain Source Body Diode Characteristics						
Source Drain Diode Forward Voltage	V_{SD}	$V_{GS}=0V, I_S=-1.6A$			-1.2	V

PARAMETER CHARACTERISTIC CURVE

Figure1: Output Characteristics

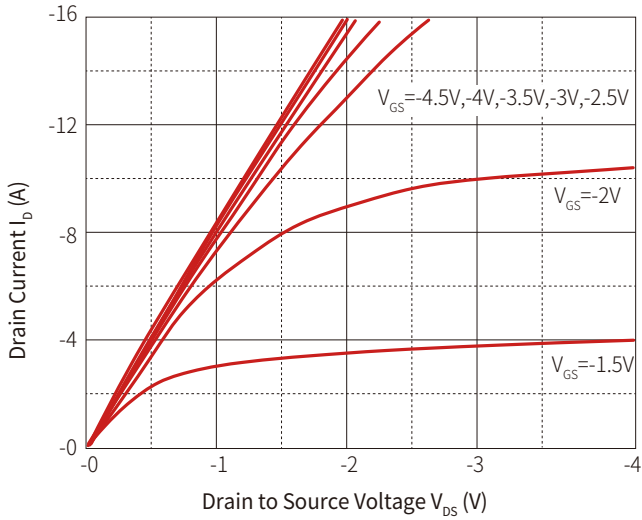

Figure2: Transfer Characteristics

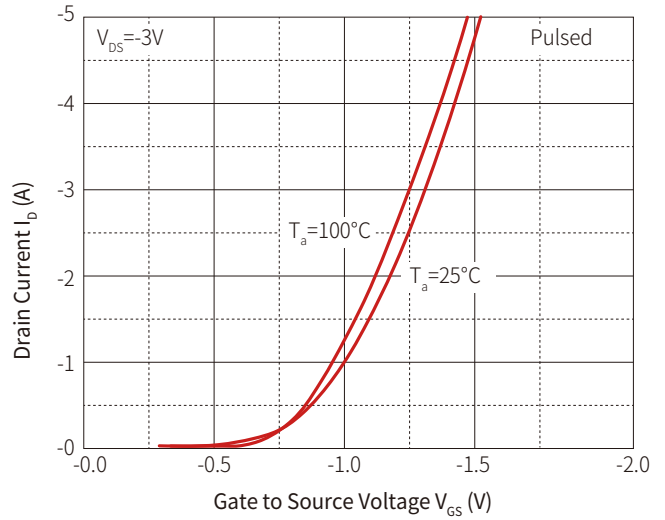

Figure3: $R_{DS(ON)}$ vs I_D

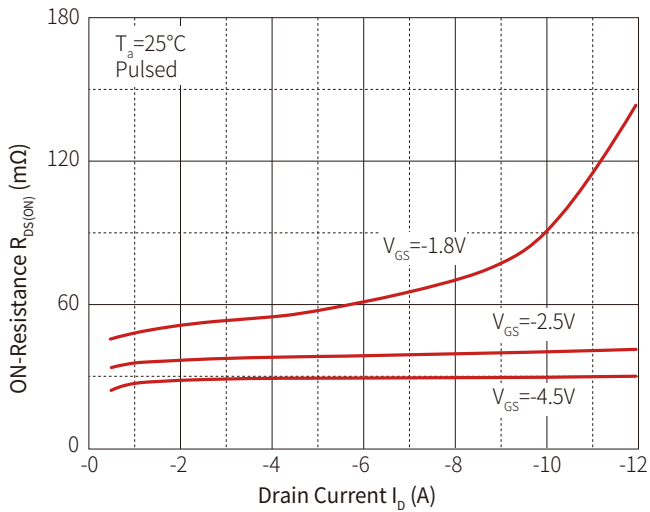
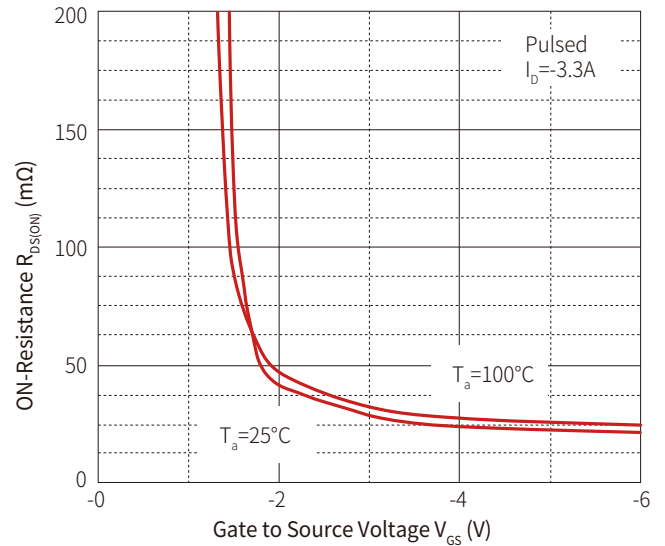
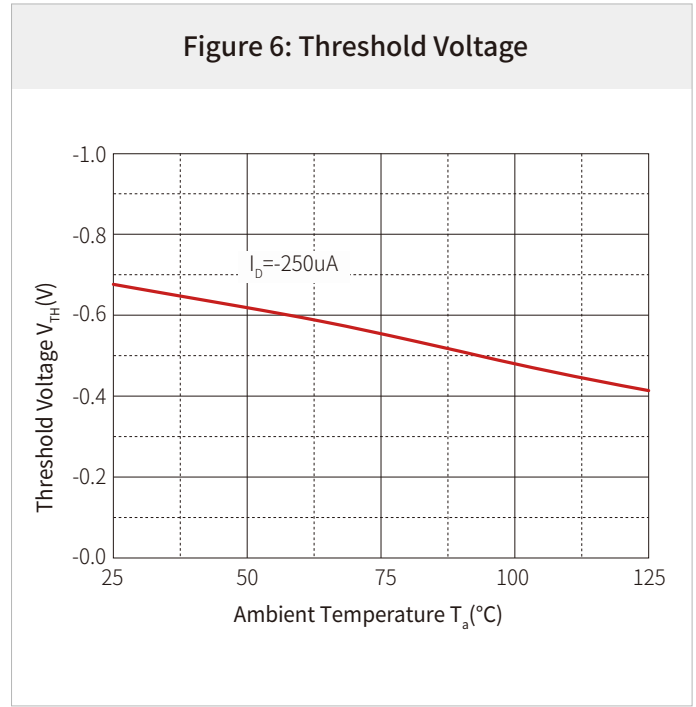
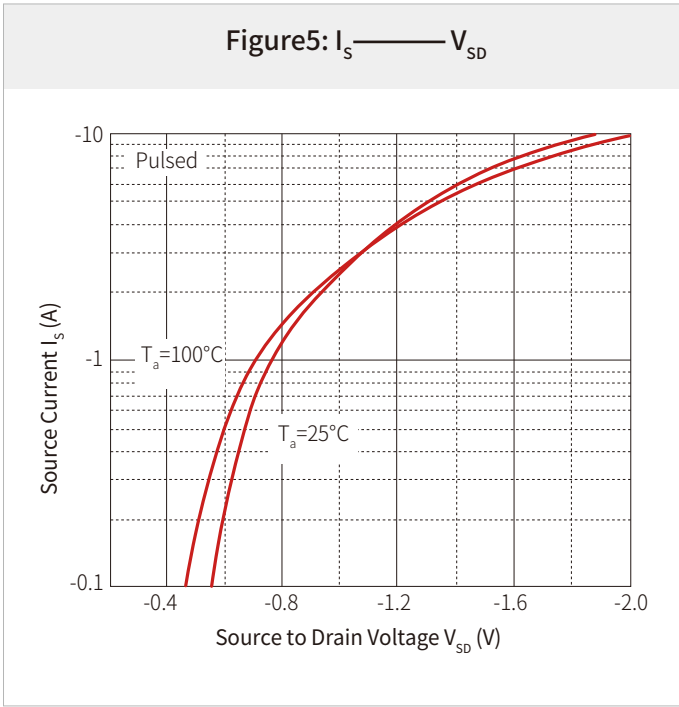
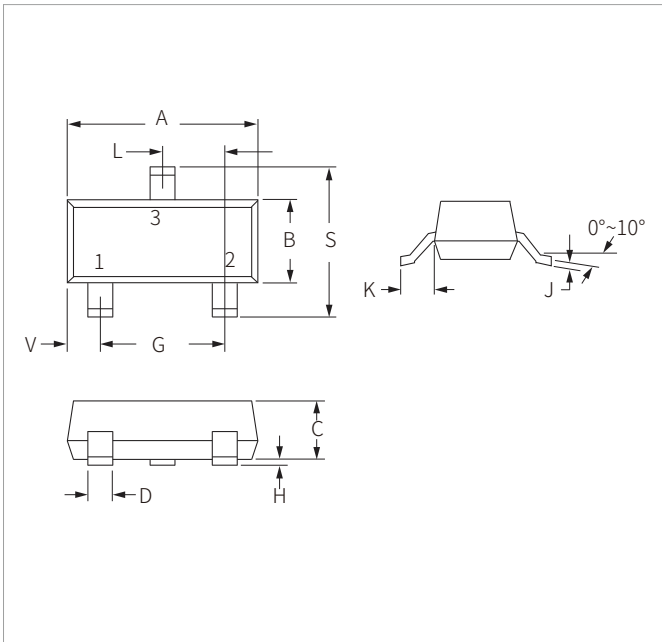

Figure4: $R_{DS(ON)}$ vs V_{GS}





SOT-23 PACKAGE INFORMATION



Ref.	Millimeters		Inches	
	Min.	Max.	Min.	Max.
A	2.80	3.05	0.110	0.120
B	1.20	1.40	0.047	0.055
C	0.90	1.15	0.035	0.045
D	0.37	0.50	0.015	0.020
G	1.75	2.05	0.069	0.081
H	0.01	0.100	0.001	0.004
J	0.085	0.180	0.003	0.007
K	0.35	0.69	0.014	0.029
L	0.89	1.02	0.035	0.040
S	2.10	2.65	0.083	0.104
V	0.45	0.60	0.018	0.024

RECOMMENDED PAD LAYOUT DIMENSIONS

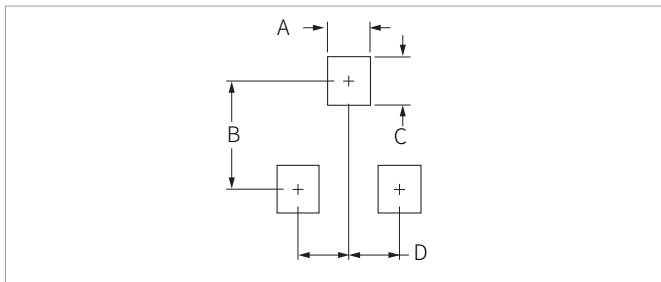

Ref.	Millimeters		Inches	
	Min	Max	Min	Max
A	0.71	0.97	0.028	0.038
B	1.88	2.13	0.074	0.084
C	0.71	0.97	0.028	0.038
D	0.81	1.07	0.032	0.042

ORDERING INFORMATION

Part Number	Component Package	QTY/Reel	Reel Size
SPM2305S	SOT-23	3000PCS	7"

Headquarters

No.3387 Shendu Road
Pujiang I&E Park
Minhang Shanghai China
201000

Hotline

400-021-5756

Web

<https://www.semiware.com>

Sales Center

Tel: 86-21-3463-7458
Email: sales18@semiware.com

Customer Service

Tel: 86-21-5484-1001
Email: sales17@semiware.com

Technical Support

Tel: 86-21-3463-7654
Email: fae01@semiware.com

Complaint & Suggestions

Tel: 86-21-3463-7172
Ext: 8868
Email: cs03@semiware.com

By QR Code

Website



Wechat

To find your local partner within Semiware' s global website: www.semiware.com

© 2022 Semiware Semiconductor Inc.

The content of this document has been carefully checked and understood. However, neither Semiware nor its subsidiaries assume any liability whatsoever for any errors or inaccuracies of this document and the consequences thereof. Published specifications are subject to change without notice. Product suitability for any area of application must ultimately be determined by the customer. In all cases, products must never be operated outside their published specifications. Semiware does not guarantee the availability of all published products. This disclaimer shall be governed by substantive Chinese law and resulting disputes shall be settled by the courts at the place of business of Semiware. Latest publications and a complete disclaimer can be downloaded from the Semiware website. All trademarks recognized.