

## FEATURES

- | Low profile package
- | Ideal for automated placement
- | 400 Watt peak pulse power capability with a 10/1000µs waveform
- | For surface mounted applications to optimize board space
- | Excellent clamping capability
- | Very fast response time
- | Low incremental surge resistance



DO-214AC(SMA)



Uni-directional



Bi-directional

## APPLICATIONS

- | Power supply protection
- | Automotive application
- | Industrial application
- | Power management

## APPROVALS

<b>RoHS</b>	Compliance with 2011/65/EU
<b>HF</b>	Compliance with IEC61249-2-21:2003

## MAXIMUM RATINGS ( $T_A=25^{\circ}\text{C}$ )

Parameter	Symbol	Value	Unit
Peak Pulse Power Dissipation on 10/1000us waveform (Note1, Note2).	$P_{PPM}$	400	Watts
Steady State Power Dissipation at $T_L=75^{\circ}\text{C}$ , Lead lengths.375" (9.5mm) ( Note2)	$P_D$	3.3	Watts

**Notes :** 1.Non-repetitive current pulse, $T_A=25^{\circ}\text{C}$ .

2.Mounted on 5.0mm x 5.0mm (0.03mm thick) Copper Pads to each terminal.

## THERMAL CONSIDERATIONS

Parameter	Symbol	Value	Unit
Operating Junction Temperature	$T_J$	-55 to +150	$^{\circ}\text{C}$
Storage Temperature Range	$T_{STG}$	-55 to +150	$^{\circ}\text{C}$
Junction to Ambient on printed circuit	$R_{\theta JA}$	120	$^{\circ}\text{C}/\text{W}$

## ELECTRICAL CHARACTERISTICS (T<sub>A</sub> = 25°C)

Part Number		Device Marking Code		Reverse Stand-off Voltage	Breakdown Voltage Min.@I <sub>T</sub>	Breakdown Voltage Max.@I <sub>T</sub>	Test Current	Maximum Clamping Voltage @I <sub>PP</sub>	Peak Pulse Current	Reverse Leakage @V <sub>RWM</sub>
Uni-Polar	Bi-Polar	Uni	Bi	V <sub>RWM</sub> (V)	V <sub>BR</sub> (V)	V <sub>BR</sub> (V)	I <sub>T</sub> (mA)	V <sub>C</sub> (V)	I <sub>PP</sub> (A)	I <sub>R</sub> (uA)
P4SMA6.8A	P4SMA6.8CA	6V8A	6V8C	5.8	6.45	7.14	10	10.5	39	1000
P4SMA7.5A	P4SMA7.5CA	7V5A	7V5C	6.4	7.13	7.88	10	11.3	36.3	500
P4SMA8.2A	P4SMA8.2CA	8V2A	8V2C	7.02	7.79	8.61	10	12.1	33.9	200
P4SMA9.1A	P4SMA9.1CA	9V1A	9V1C	7.78	8.65	9.55	1	13.4	30.6	50
P4SMA10A	P4SMA10CA	10A	10C	8.55	9.5	10.5	1	14.5	28.3	10
P4SMA11A	P4SMA11CA	11A	11C	9.4	10.5	11.6	1	15.6	26.3	5
P4SMA12A	P4SMA12CA	12A	12C	10.2	11.4	12.6	1	16.7	24.6	5
P4SMA13A	P4SMA13CA	13A	13C	11.1	12.4	13.7	1	18.2	22.5	1
P4SMA15A	P4SMA15CA	15A	15C	12.8	14.3	15.8	1	21.2	19.3	1
P4SMA16A	P4SMA16CA	16A	16C	13.6	15.2	16.8	1	22.5	18.2	1
P4SMA18A	P4SMA18CA	18A	18C	15.3	17.1	18.9	1	25.5	16.1	1
P4SMA20A	P4SMA20CA	20A	20C	17.1	19.0	21.0	1	27.7	14.8	1
P4SMA22A	P4SMA22CA	22A	22C	18.8	20.9	23.1	1	30.6	13.4	1
P4SMA24A	P4SMA24CA	24A	24C	20.5	22.8	25.2	1	33.2	12.3	1
P4SMA27A	P4SMA27CA	27A	27C	23.1	25.7	28.4	1	37.5	10.9	1
P4SMA30A	P4SMA30CA	30A	30C	25.6	28.5	31.5	1	41.4	9.9	1
P4SMA33A	P4SMA33CA	33A	33C	28.2	31.4	34.7	1	45.7	9.0	1
P4SMA36A	P4SMA36CA	36A	36C	30.8	34.2	37.8	1	49.9	8.2	1
P4SMA39A	P4SMA39CA	39A	39C	33.3	37.1	41.0	1	53.9	7.6	1
P4SMA43A	P4SMA43CA	43A	43C	36.8	40.9	45.2	1	59.3	6.9	1
P4SMA47A	P4SMA47CA	47A	47C	40.2	44.7	49.4	1	64.8	6.3	1
P4SMA51A	P4SMA51CA	51A	51C	43.6	48.5	53.6	1	70.1	5.8	1
P4SMA56A	P4SMA56CA	56A	56C	47.8	53.2	58.8	1	77.0	5.3	1
P4SMA62A	P4SMA62CA	62A	62C	53.0	58.9	65.1	1	85.0	4.8	1
P4SMA68A	P4SMA68CA	68A	68C	58.1	64.6	71.4	1	92.0	4.5	1
P4SMA75A	P4SMA75CA	75A	75C	64.1	71.30	78.8	1	103	4.0	1
P4SMA82A	P4SMA82CA	82A	82C	70.1	77.9	86.1	1	113	3.6	1
P4SMA91A	P4SMA91CA	91A	91C	77.8	86.5	95.5	1	125	3.3	1
P4SMA100A	P4SMA100CA	100A	100C	85.5	95	105	1	137	3.0	1
P4SMA110A	P4SMA110CA	110A	110C	94.0	105	116	1	152	2.7	1
P4SMA120A	P4SMA120CA	120A	120C	102	114	126	1	165	2.5	1
P4SMA130A	P4SMA130CA	130A	130C	111	124	137	1	179	2.3	1

Part Number		Device Marking Code		Reverse Stand-off Voltage	Breakdown Voltage Min.@I <sub>T</sub>	Breakdown Voltage Max.@I <sub>T</sub>	Test Current	Maximum Clamping Voltage @I <sub>PP</sub>	Peak Pulse Current	Reverse Leakage @V <sub>RWM</sub>
Uni-Polar	Bi-Polar	Uni	Bi	V <sub>RWM</sub> (V)	V <sub>BR</sub> (V)	V <sub>BR</sub> (V)	I <sub>T</sub> (mA)	V <sub>C</sub> (V)	I <sub>PP</sub> (A)	I <sub>R</sub> (uA)
P4SMA150A	P4SMA150CA	150A	150C	128	143	158	1	207	2.0	1
P4SMA160A	P4SMA160CA	160A	160C	136	152	168	1	219	1.9	1
P4SMA170A	P4SMA170CA	170A	170C	145	162	179	1	234	1.8	1
P4SMA180A	P4SMA180CA	180A	180C	154	171	189	1	246	1.7	1
P4SMA200A	P4SMA200CA	200A	200C	171	190	210	1	274	1.5	1
P4SMA220A	P4SMA220CA	220A	220C	185	209	231	1	328	1.3	1
P4SMA250A	P4SMA250CA	250A	250C	214	237	263	1	344	1.2	1
P4SMA300A	P4SMA300CA	300A	300C	256	285	315	1	414	1.0	1
P4SMA350A	P4SMA350CA	350A	350C	300	332	368	1	482	0.85	1
P4SMA400A	P4SMA400CA	400A	400C	342	380	420	1	548	0.75	1
P4SMA440A	P4SMA440CA	440A	440C	376	418	462	1	602	0.68	1
P4SMA480A	P4SMA480CA	480A	480C	408	456	504	1	658	0.61	1
P4SMA510A	P4SMA510CA	510A	510C	434	485	535	1	698	0.57	1
P4SMA530A	P4SMA530CA	530A	530C	451	503.5	556.5	1	725	0.55	1
P4SMA540A	P4SMA540CA	540A	540C	459	513	567	1	740	0.54	1
P4SMA550A	P4SMA550CA	550A	550C	467	522.5	577.5	1	760	0.52	1
P4SMA600A	P4SMA600CA	600A	600C	510	570	630	1	828	0.48	1

# CHARACTERISTIC CURVES

TVS Transients Clamping Waveform

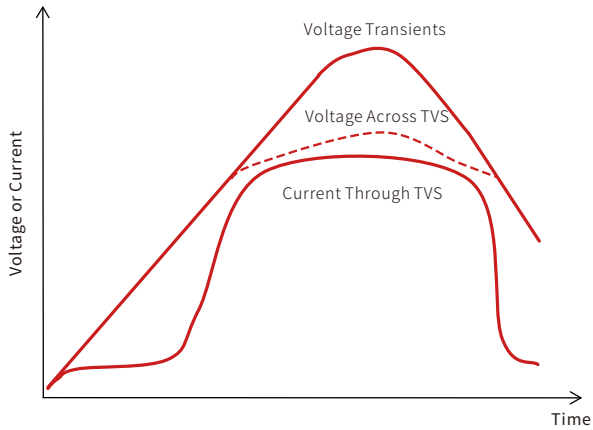

Peak Pulse Power Rating Curve

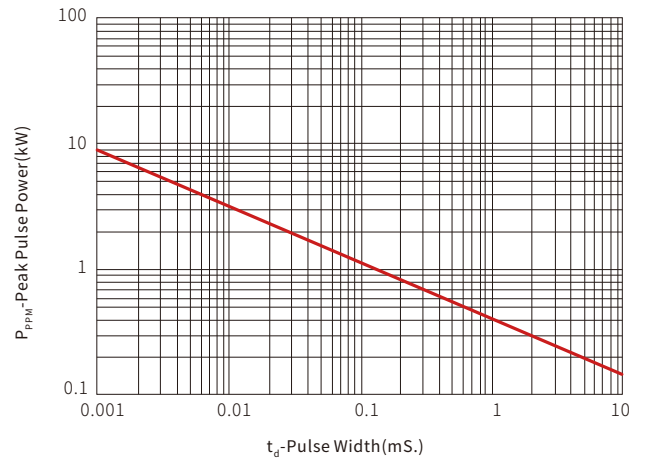

Pulse Derating Curve

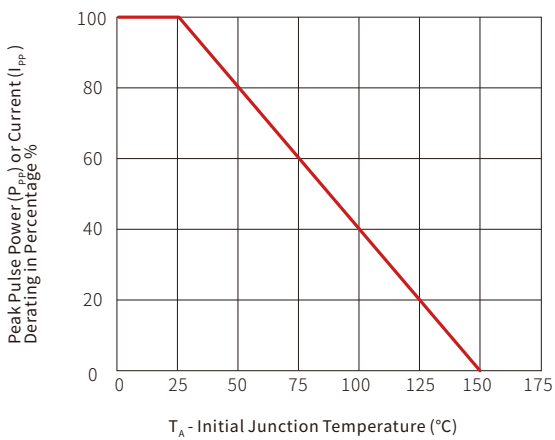

Pulse Waveform

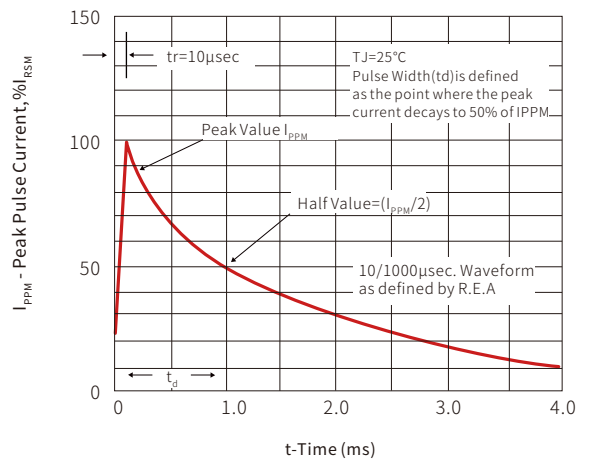

**Typical Junction Capacitance**

**Steady State Power Dissipation Derating Curve**

## SOLDERING PARAMETERS

Reflow Condition		Lead-free assembly
Pre Heat	Temperature Max ( $T_{s(min)}$ )	150°C
	Temperature Max ( $T_{s(max)}$ )	200°C
	Time (min to max) ( $t_s$ )	60 – 180 secs
Average ramp up rate (Liquidus Temp ( $T_L$ ) to peak)		3°C/second max
$T_{s(max)}$ to $T_L$ - Ramp-up Rate		3°C/second max
Reflow	Temperature ( $T_L$ ) (Liquidus)	217°C
	Time (min to max) ( $t_i$ )	60 – 150 seconds
Peak Temperature ( $T_p$ )		260°C
Time within 5°C of actual peak Temperature ( $t_p$ )		20 – 40 seconds
Ramp-down Rate		6°C/second max
Time 25°C to peak Temperature ( $T_p$ )		8 minutes max.
Do not exceed		260°C

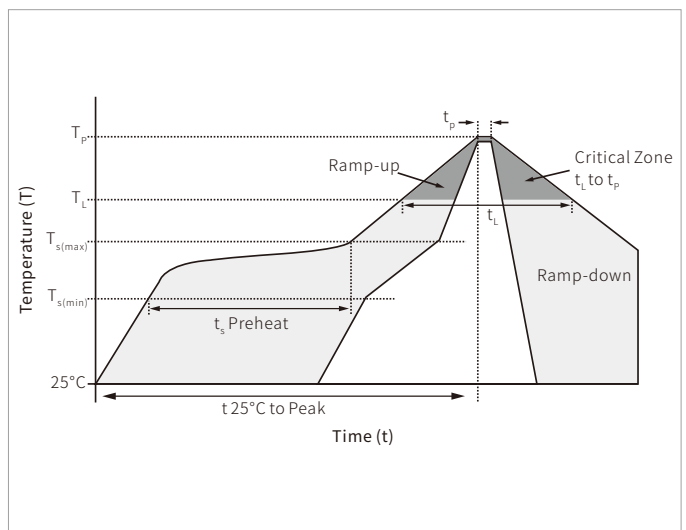

## DO-214AC(SMA) PACKAGE INFORMATION

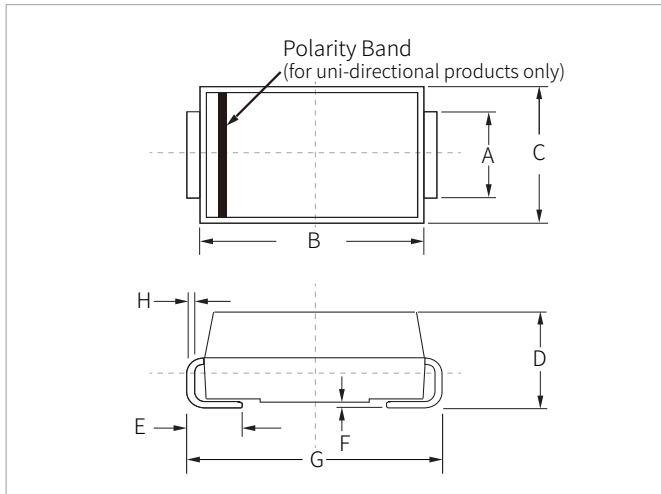

Ref.	Millimeters		Inches	
	Min.	Max.	Min.	Max.
A	1.20	1.60	0.047	0.063
B	4.20	4.60	0.165	0.181
C	2.40	2.80	0.094	0.110
D	2.00	2.40	0.079	0.094
E	0.76	1.52	0.030	0.060
F	0.02	0.20	0.001	0.008
G	4.85	5.25	0.191	0.207
H	0.15	0.30	0.006	0.012

## RECOMMENDED PAD LAYOUT DIMENSIONS

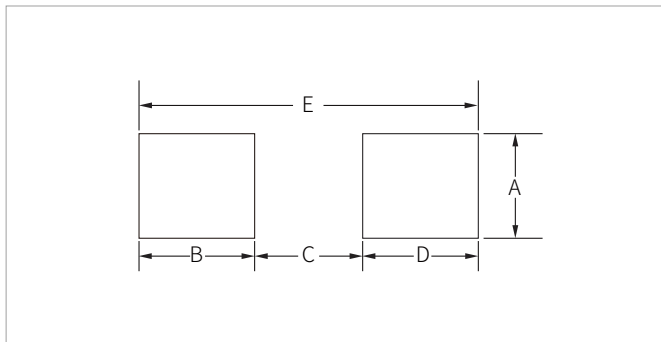

Ref.	Millimeters		Inches	
	Min.	Max.	Min.	Max.
A	1.63	-	0.064	-
B	1.45	-	0.057	-
C	-	2.80	-	0.090
D	1.45	-	0.057	-
E	5.28REF		0.208REF	

## ORDERING INFORMATION

Part Number	Component Package	QTY/Reel	Reel Size
P4SMAxx(C)A	DO-214AC(SMA)	5000PCS	13"

**Headquarters**

No.3387 Shendu Road  
Pujiang I&E Park  
Minhang Shanghai China  
201000

**Hotline**

400-021-5756

**Web**

[Https://www.semiware.com](https://www.semiware.com)

**Sales Center**

Tel: 86-21-3463-7458  
Email: [sales18@semiware.com](mailto:sales18@semiware.com)

**Customer Service**

Tel: 86-21-5484-1001  
Email: [sales17@semiware.com](mailto:sales17@semiware.com)

**Technical Support**

Tel: 86-21-3463-7654  
Email: [fae01@semiware.com](mailto:fae01@semiware.com)

**Complaint & Suggestions**

Tel: 86-21-3463-7172  
Ext: 8868  
Email: [cs03@semiware.com](mailto:cs03@semiware.com)

**By QR Code**

Website



Wechat

To find your local partner within Semiware' s global website: [www.semiware.com](http://www.semiware.com)

© 2022 Semiware Semiconductor Inc.

The content of this document has been carefully checked and understood. However, neither Semiware nor its subsidiaries assume any liability whatsoever for any errors or inaccuracies of this document and the consequences thereof. Published specifications are subject to change without notice. Product suitability for any area of application must ultimately be determined by the customer. In all cases, products must never be operated outside their published specifications. Semiware does not guarantee the availability of all published products. This disclaimer shall be governed by substantive Chinese law and resulting disputes shall be settled by the courts at the place of business of Semiware. Latest publications and a complete disclaimer can be downloaded from the Semiware website. All trademarks recognized.