

FEATURES

- | Low Forward Voltage Drop
- | Ideal For Automated Placement
- | Glass Passivated Chip Junction
- | High Surge Current Capability
- | Meet AEC-Q101 Requirements

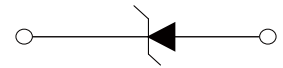

SOD-123FL



Schematic Symbol

APPLICATIONS

- | For Use In General Purpose Switching Rectification Of Power Supply, Inverters, Converters, And Freewheeling Diodes For Consumer And Telecommunication.

APPROVALS

RoHS	Compliance with 2011/65/EU
HF	Compliance with IEC61249-2-21:2003

MAXIMUM RATINGS AND CHARACTERISTICS (T_A=25°C)

Parameter	Symbol	1N4001 WQ	1N4002 WQ	1N4003 WQ	1N4004 WQ	1N4005 WQ	1N4006 WQ	1N4007 WQ	Unit
Marking		A1Q	A2Q	A3Q	A4Q	A5Q	A6Q	A7Q	
Maximum Repetitive Peak Reverse Voltage	V _{RRM}	50	100	200	400	600	800	1000	
Maximum RMS Voltage	V _{RMS}	35	70	140	280	420	560	700	V
Maximum DC Blocking Voltage	V _{DC}	50	100	200	400	600	800	1000	
Average Rectified Output Current @60Hz Sine Wave, Resistance Load, TL (FIG.1)	I _O	1.0							
Forward Surge Current (Non-Repetitive) @60Hz Half-Sine Wave, 1 cycle, T _j =25°C	I _{FSM}	30							A
Forward Surge Current (Non-Repetitive) @1ms, Square Wave, 1 cycle, T _j =25°C		60							
Maximum Instantaneous Forward Voltage I _{FM} =1.0A	V _F	1.1							V
Maximum DC Reverse Current at Rated DC Blocking Voltage	I _R	5							μA
		100							
Typical Junction Capacitance Measured at 1MHz and Applied Reverse Voltage of 4.0 V.D.C	C _J	7							pF
Current Squared Time @1ms ≤ t ≤ 8.3ms T _j =25°C	I ² t	3.735							A ² s
Operating and Storage Temperature Range	T _J , T _{STG}	-55 to +150							°C

THERMAL CHARACTERISTICS ($T_A=25^{\circ}\text{C}$)

Parameter	Symbol	1N4001 WQ	1N4002 WQ	1N4003 WQ	1N4004 WQ	1N4005 WQ	1N4006 WQ	1N4007 WQ	Unit	
Typical Thermal resistance	$R_{\theta\text{-J-A}}^{(1)}$					70				$^{\circ}\text{C/W}$
	$R_{\theta\text{-J-L}}^{(1)}$					20				
	$R_{\theta\text{-J-C}}^{(1)}$					18				

Note: (1) Thermal resistance between junction and ambient and between junction and lead mounted on P.C.B with 3mm*3mm copper pad areas.

CHARACTERISTIC CURVES

Fig.1 I_o - T_L Curve

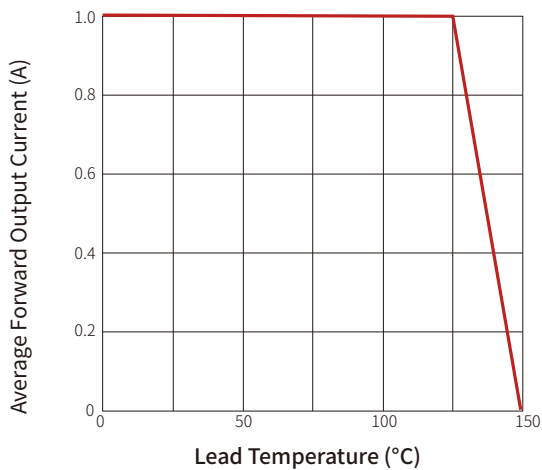

Fig.2 Forward Surge Current Capability

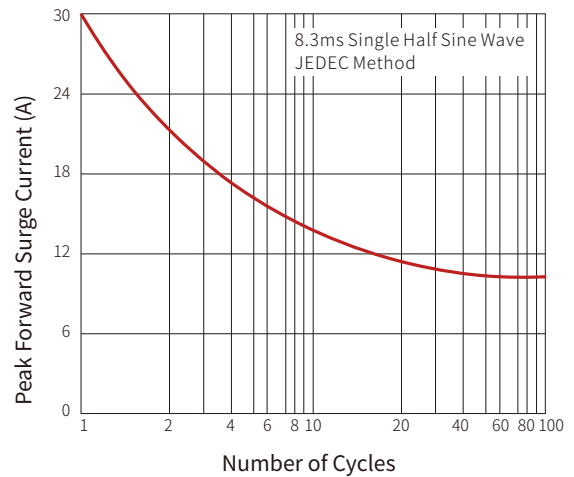

Fig.3 Typical Forward Voltage

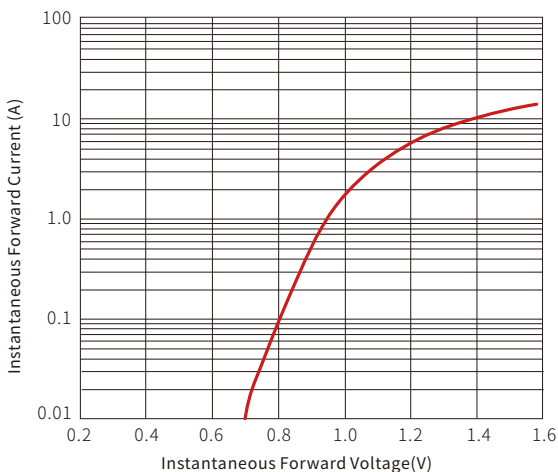
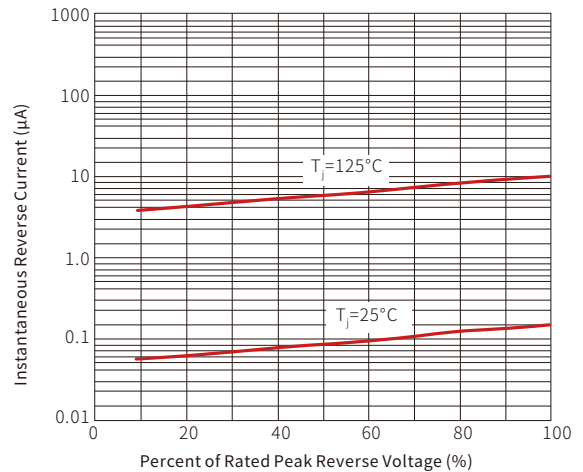
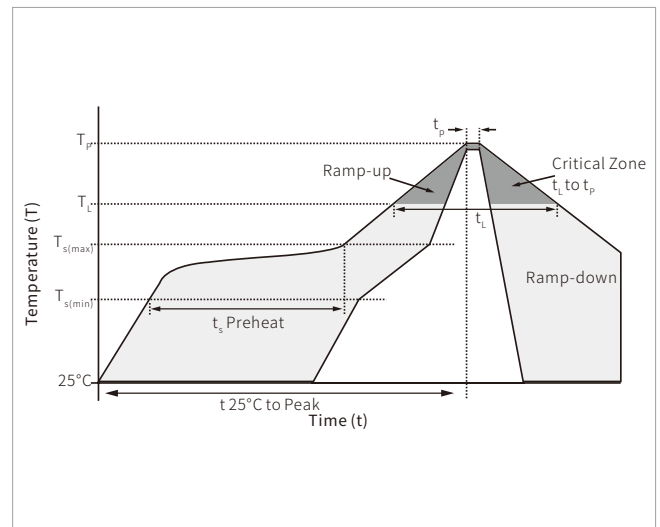

Fig.4 Typical Reverse Characteristics



SOLDERING PARAMETERS

Reflow Condition		Lead-free assembly
Pre Heat	Temperature Max ($T_{s(min)}$)	150°C
	Temperature Max ($T_{s(max)}$)	200°C
	Time (min to max) (t_s)	60 – 180 secs
Average ramp up rate (Liquidus Temp (T_L) to peak)		3°C/second max
$T_{s(max)}$ to T_L - Ramp-up Rate		3°C/second max
Reflow	Temperature (T_L) (Liquidus)	217°C
	Time (min to max) (t_L)	60 – 150 seconds
Peak Temperature (T_p)		260°C
Time within 5°C of actual peak Temperature (t_p)		20 – 40 seconds
Ramp-down Rate		6°C/second max
Time 25°C to peak Temperature (T_p)		8 minutes max.
Do not exceed		260°C



SOD-123FL PACKAGE INFORMATION

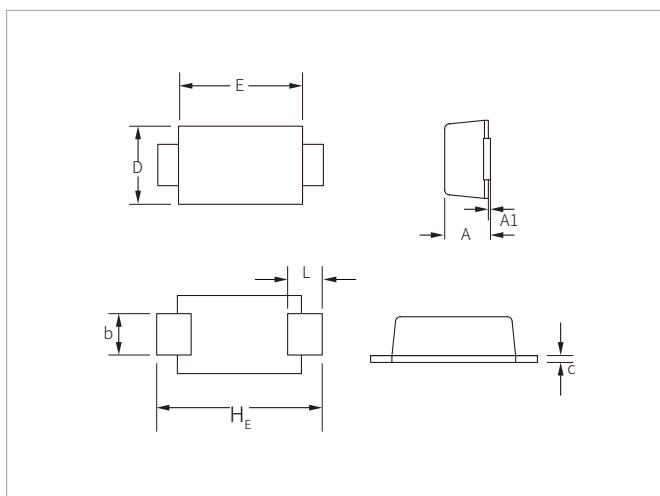

Ref.	Millimeters		Inches	
	Min.	Max.	Min.	Max.
A	0.95	1.45	0.037	0.057
A1	0.00	0.10	0.000	0.004
b	0.70	1.20	0.028	0.047
c	0.05	0.30	0.002	0.012
D	1.50	2.00	0.059	0.079
E	2.50	2.90	0.098	0.114
L	0.35	0.90	0.014	0.035
H _E	3.40	3.90	0.134	0.154

RECOMMENDED PAD LAYOUT DIMENSIONS

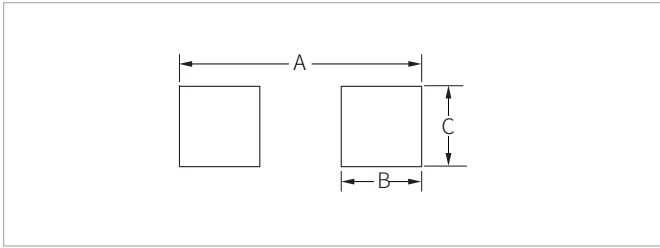

Ref.	Millimeters	Inches
A	4.20	0.165
B	1.50	0.059
C	1.20	0.047

ORDERING INFORMATION

Part Number	Component Package	QTY/Reel	Reel Size
1N4001WQ-1N4007WQ	SOD-123FL	3000PCS	7"

Headquarters

No.3387 Shendu Road
Pujiang I&E Park
Minhang Shanghai China
201000

Hotline

400-021-5756

Web

<https://www.semiware.com>

Sales Center

Tel: 86-21-3463-7458
Email: sales18@semiware.com

Customer Service

Tel: 86-21-5484-1001
Email: sales17@semiware.com

Technical Support

Tel: 86-21-3463-7654
Email: fae01@semiware.com

Complaint & Suggestions

Tel: 86-21-3463-7172
Ext: 8868
Email: cs03@semiware.com

By QR Code

Website



Wechat

To find your local partner within Semiware' s global website: www.semiware.com

© 2022 Semiware Semiconductor Inc.

The content of this document has been carefully checked and understood. However, neither Semiware nor its subsidiaries assume any liability whatsoever for any errors or inaccuracies of this document and the consequences thereof. Published specifications are subject to change without notice. Product suitability for any area of application must ultimately be determined by the customer. In all cases, products must never be operated outside their published specifications. Semiware does not guarantee the availability of all published products. This disclaimer shall be governed by substantive Chinese law and resulting disputes shall be settled by the courts at the place of business of Semiware. Latest publications and a complete disclaimer can be downloaded from the Semiware website. All trademarks recognized.