

FEATURES

- | Photo Glass passivated junction
- | Ideal for automated placement
- | Low inductance

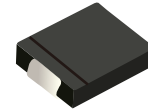

DO-214AB(SMC)

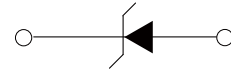

Schematic Symbol

APPLICATIONS

- | Switching mode power supply (SMPS)
- | Adapters
- | Lighting application
- | On-board DC/DC converter

APPROVALS

RoHS	Compliance with 2011/65/EU
HF	Compliance with IEC61249-2-21:2003

MAXIMUM RATINGS ($T_A=25^{\circ}\text{C}$)

Parameter	Symbo	Value	Unit
DC power dissipation at $T_L=75^{\circ}\text{C}$, measure at zero lead length (Note 1) derate above 75°C	P_D	5	W
Junction-to-lead thermal resistance	$R_{\theta JL}$	20	$^{\circ}\text{C}/\text{W}$
Junction-to-ambient thermal resistance	$R_{\theta JA}$	55	$^{\circ}\text{C}/\text{W}$
Junction-to-case thermal resistance	$R_{\theta JC}$	22	$^{\circ}\text{C}/\text{W}$
Operation Junction and Storage Temperature Range	T_J, T_{STG}	-55 to +175	$^{\circ}\text{C}$

Notes: 1. Mounted on Cu-Pad size 16mm x 16mm on PCB
 Thermal Performance Note: Units mounted on PCB (16mm x 16mm Cu pad test board)

ELECTRICAL CHARACTERISTICS

Part Number	Device Marking Code	Nominal Zener Voltage			Test current	Zener Impedance			Leakage Current		Maximum DC Zener Current
		$V_Z@I_{ZT}$			I_{ZT}	$Z_{ZT}@I_{ZT}$	$Z_{ZK}@I_{ZK}$		$I_R@V_R$		I_{ZM}
		Min.(V)	Nom.(V)	Max.(V)	mA	Ω	Ω	mA	μA	V	mA
1SMC5348B	348B	10.45	11	11.55	125	3	125	1	5	8.4	430
1SMC5349B	349B	11.40	12	12.60	100	3	150	1	2	9.1	395
1SMC5350B	350B	12.35	13	13.65	100	3	150	1	1	9.9	365
1SMC5351B	351B	13.30	14	14.70	100	3	150	1	1	10.6	345
1SMC5352B	352B	14.25	15	15.75	75	3	150	1	1	11.5	315
1SMC5353B	353B	15.20	16	16.80	75	3	150	1	1	12.2	295
1SMC5354B	354B	16.15	17	17.85	70	3	150	1	0.5	12.9	280
1SMC5355B	355B	17.10	18	18.90	65	3	150	1	0.5	13.7	264
1SMC5356B	356B	18.05	19	19.95	65	3	150	1	0.5	14.4	250
1SMC5357B	357B	19.00	20	21.00	65	3	150	1	0.5	15.2	237
1SMC5358B	358B	20.90	22	23.10	50	4	150	1	0.5	16.7	216
1SMC5359B	359B	22.80	24	25.20	50	4	180	1	0.5	18.2	198
1SMC5360B	360B	23.75	25	26.25	50	4	180	1	0.5	19.0	190
1SMC5361B	361B	25.65	27	28.35	50	5	180	1	0.5	20.6	176
1SMC5362B	362B	26.60	28	29.40	50	6	180	1	0.5	21.2	170
1SMC5363B	363B	28.50	30	31.35	40	8	180	1	0.5	22.8	158
1SMC5364B	364B	31.35	33	34.65	40	10	180	1	0.5	25.1	144
1SMC5365B	365B	34.20	36	37.80	30	11	200	1	0.5	27.4	132
1SMC5366B	366B	37.05	39	40.95	30	14	200	1	0.5	29.7	122
1SMC5367B	367B	40.85	43	45.15	30	20	200	1	0.5	32.7	110
1SMC5368B	368B	44.65	47	49.35	25	25	200	1	0.5	35.8	100
1SMC5369B	369B	48.45	51	53.55	25	27	200	1	0.5	38.8	93

Notes:

1. Tolerance and type number designation the type numbers listed indicate a tolerance of 5%

CHARACTERISTIC CURVES

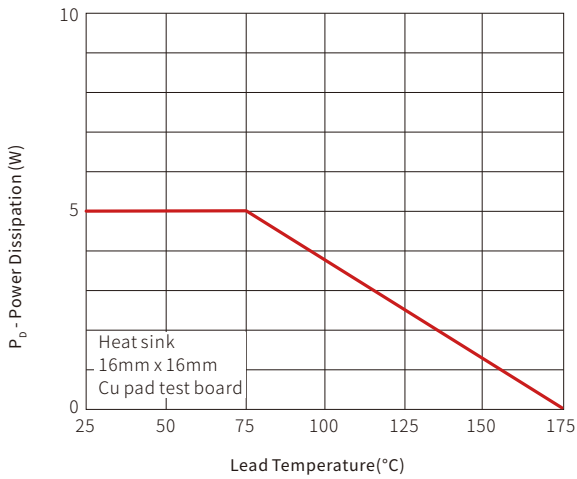
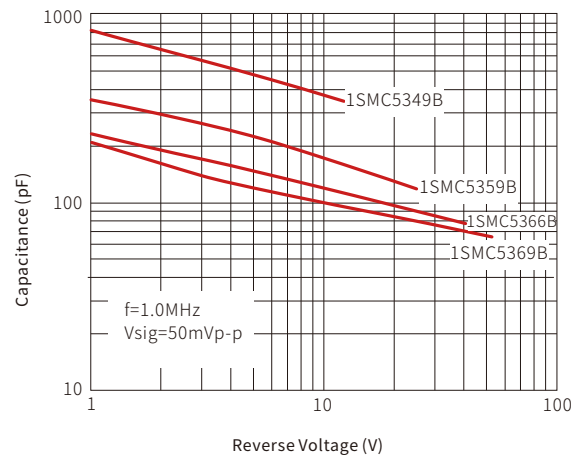
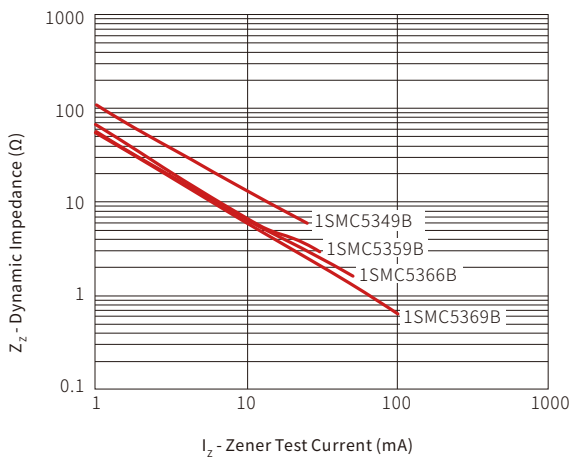
Fig.1 Steady State Power Derating

Fig.2 Typical Junction Capacitance

Fig.3 Typical Zener Impedance

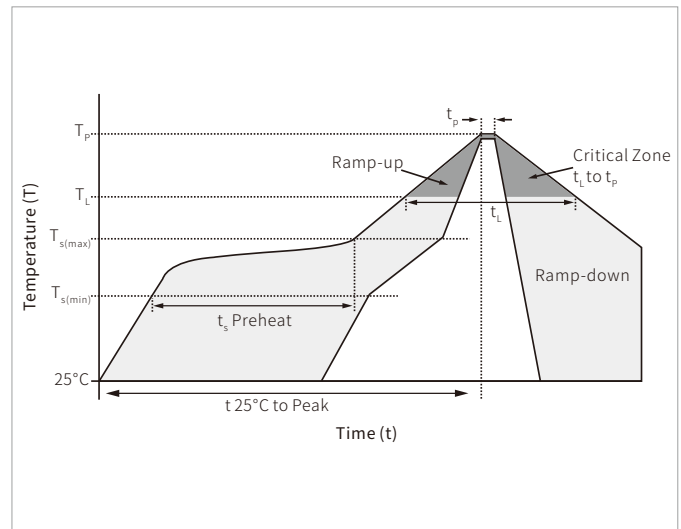
SOLDERING PARAMETERS

Reflow Condition		Lead-free assembly
Pre Heat	Temperature Max ($T_{s(min)}$)	150°C
	Temperature Max ($T_{s(max)}$)	200°C
	Time (min to max) (t_s)	60 – 180 secs
Average ramp up rate (Liquidus Temp (T_L) to peak		3°C/second max
$T_{s(max)}$ to T_L - Ramp-up Rate		3°C/second max
Reflow	Temperature (T_L) (Liquidus)	217°C
	Time (min to max) (t_L)	60 – 150 seconds
Peak Temperature (T_p)		260°C
Time within 5°C of actual peak Temperature (t_p)		20 – 40 seconds
Ramp-down Rate		6°C/second max
Time 25°C to peak Temperature (T_p)		8 minutes max.
Do not exceed		260°C

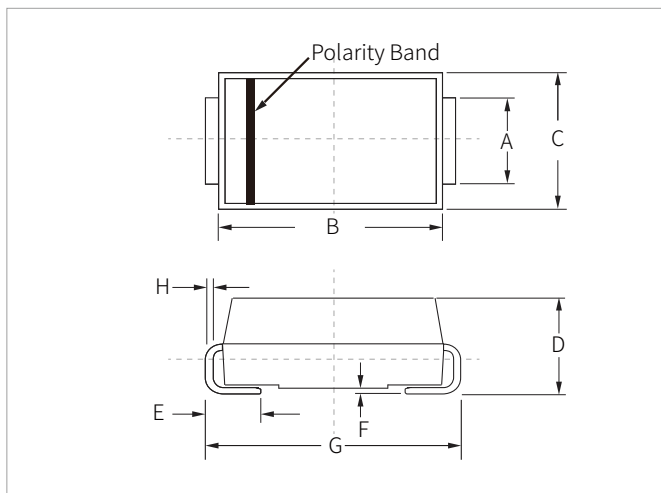

DO-214AB(SMC) PACKAGE INFORMATION



Ref.	Millimeters		Inches	
	Min.	Max.	Min.	Max.
A	2.80	3.20	0.110	0.126
B	6.60	7.20	0.260	0.283
C	5.70	6.10	0.224	0.240
D	2.15	2.75	0.085	0.108
E	1.00	1.60	0.039	0.063
F	0.02	0.20	0.000	0.008
G	7.60	8.00	0.299	0.315
H	0.15	0.30	0.006	0.012

RECOMMENDED PAD LAYOUT DIMENSIONS

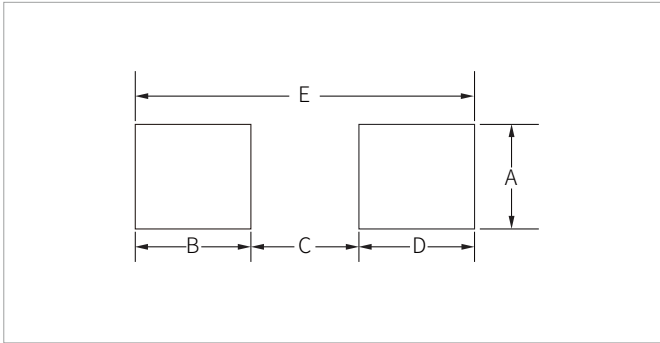

Ref.	Millimeters		Inches	
	Min.	Max.	Min.	Max.
A	3.30	-	0.129	-
B	2.40	-	0.094	-
C	-	4.20	-	0.165
D	2.40	-	0.094	-
E	8.20REF		0.323REF	

ORDERING INFORMATION

Part Number	Component Package	QTY/Reel	Reel Size
1SMC5348B -1SMC5369B	DO-214AB(SMC)	3000PCS	13"

Headquarters

No.3387 Shendu Road
Pujiang I&E Park
Minhang Shanghai China
201000

Hotline

400-021-5756

Web

<https://www.semiware.com>

Sales Center

Tel: 86-21-3463-7458
Email: sales18@semiware.com

Customer Service

Tel: 86-21-5484-1001
Email: sales17@semiware.com

Technical Support

Tel: 86-21-3463-7654
Email: fae01@semiware.com

Complaint & Suggestions

Tel: 86-21-3463-7172
Ext: 8868
Email: cs03@semiware.com

By QR Code

Website



Wechat

To find your local partner within Semiware' s global website: www.semiware.com

© 2022 Semiware Semiconductor Inc.

The content of this document has been carefully checked and understood. However, neither Semiware nor its subsidiaries assume any liability whatsoever for any errors or inaccuracies of this document and the consequences thereof. Published specifications are subject to change without notice. Product suitability for any area of application must ultimately be determined by the customer. In all cases, products must never be operated outside their published specifications. Semiware does not guarantee the availability of all published products. This disclaimer shall be governed by substantive Chinese law and resulting disputes shall be settled by the courts at the place of business of Semiware. Latest publications and a complete disclaimer can be downloaded from the Semiware website. All trademarks recognized.