

FEATURES

- | Fast Switching Device (TRR <50 nS)
- | Power Dissipation of 225mW
- | High Stability and High Reliability
- | Low Reverse Leakage

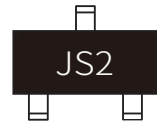

SOT-23



Marking

MECHANICAL DATA

- | SOT-23 Small Outline Plastic Package
- | Epoxy UL: 94V-0
- | Mounting Position: Any

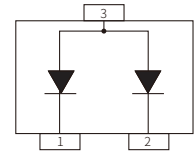

Schematic Symbol

APPROVALS

- RoHS** | Compliance with 2011/65/EU
- HF** | Compliance with IEC61249-2-21:2003

MAXIMUM RATINGS ($T_A=25^{\circ}\text{C}$)

| Parameter | Symbol | Value | Unit |
|---|-----------------|-------------|-----------------------------|
| Reverse Voltage | V_R | 250 | V |
| Peak Repetitive Reverse Voltage | V_{RRM} | 250 | V |
| Power Dissipation | P_D | 225 | mW |
| Forward Continuous Current | I_{FM} | 400 | mA |
| Repetitive Peak Forward Surge Current | I_{FRM} | 625 | mA |
| Non-Repetitive Peak Forward Surge Current @t=8.3ms; $T_A=25^{\circ}\text{C}$ | I_{FSM} | 2.5 | A |
| Operating Junction Temperature | T_J | 150 | $^{\circ}\text{C}$ |
| Storage Temperature Range | T_S | -55 to +150 | $^{\circ}\text{C}$ |
| Thermal Resistance from Junction to Ambient | $R_{\theta JA}$ | 555 | $^{\circ}\text{C}/\text{W}$ |

Valid provided that electrodes are kept at ambient temperature.

ELECTRICAL CHARACTERISTICS($T_A=25^{\circ}\text{C}$)

| Parameter | Test Condition | Symbol | Min. | Max. | Unit |
|-------------------------|------------------------------------|------------|------|------|---------------|
| Reverse Voltage | $I_R = 100\mu\text{A}$ | $V_{(BR)}$ | 250 | | V |
| Reverse Leakage Current | $V_R = 200\text{V}$ | I_R | | 0.1 | μA |
| Forward Voltage | $I_F = 100\text{mA}$ | V_F | | 1.00 | V |
| | $I_F = 200\text{mA}$ | | | 1.25 | |
| Reverse Recovery Time | $I_F = I_R = 30\text{mA}$ | T_{RR} | | 50 | nS |
| | $R_L = 100\Omega$ | | | | |
| | $I_{RR} = 0.1 \times I_R$ | | | | |
| Capacitance | $V_R = 0\text{V}, f = 1\text{MHz}$ | C_T | | 5 | pF |

CHARACTERISTIC CURVES

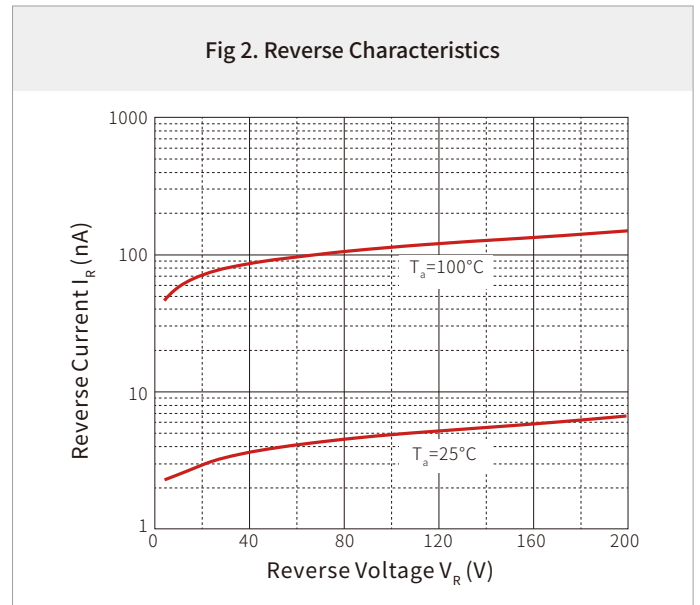
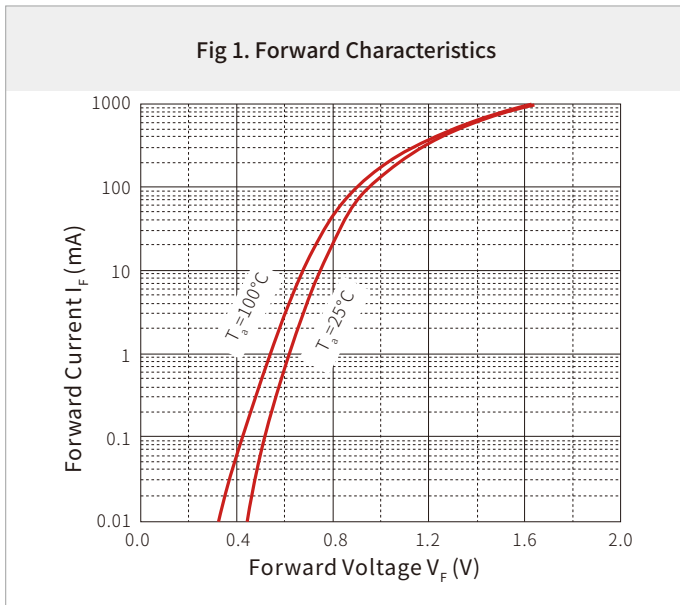
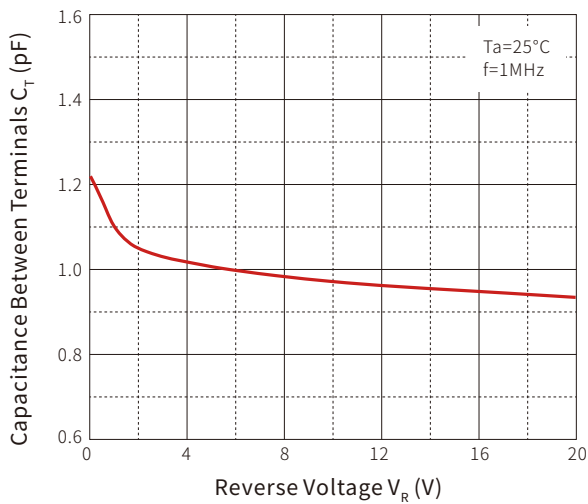
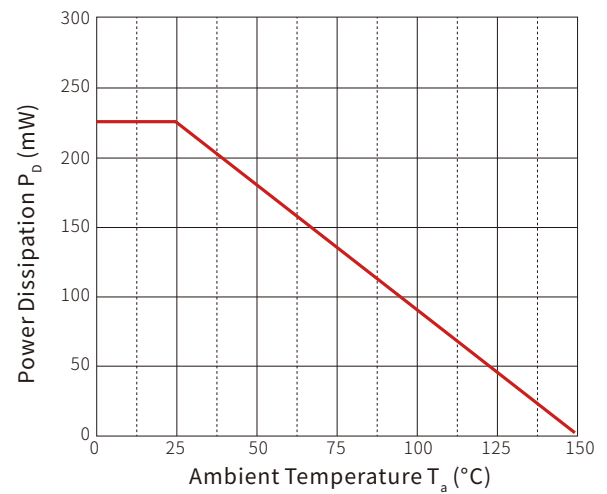
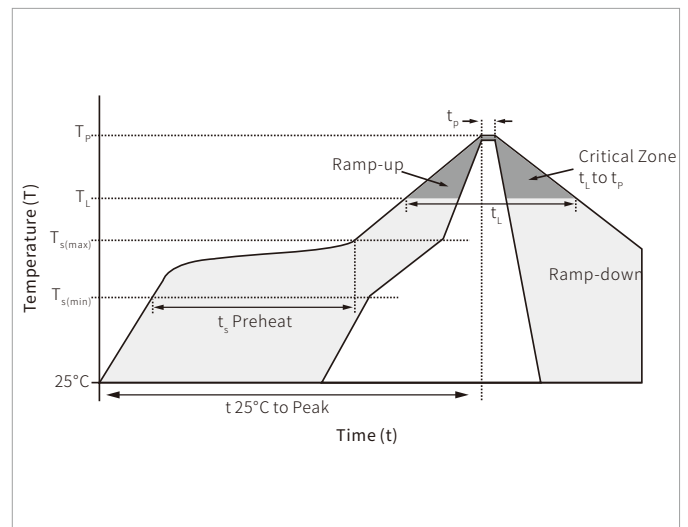

Fig 3. Capacitance Characteristics

Fig 4. Power Derating Curve

SOLDERING PARAMETERS

| Reflow Condition | | Lead-free assembly |
|--|-----------------------------------|--------------------|
| Pre Heat | Temperature Max ($T_{s(\min)}$) | 150°C |
| | Temperature Max ($T_{s(\max)}$) | 200°C |
| | Time (min to max) (t_s) | 60 – 180 secs |
| Average ramp up rate (Liquidus Temp (T_L) to peak) | | 3°C/second max |
| $T_{s(\max)}$ to T_L - Ramp-up Rate | | 3°C/second max |
| Reflow | Temperature (T_L) (Liquidus) | 217°C |
| | Time (min to max) (t_L) | 60 – 150 seconds |
| Peak Temperature (T_p) | | 260°C |
| Time within 5°C of actual peak Temperature (t_p) | | 20 – 40 seconds |
| Ramp-down Rate | | 6°C/second max |
| Time 25°C to peak Temperature (T_p) | | 8 minutes max. |
| Do not exceed | | 260°C |

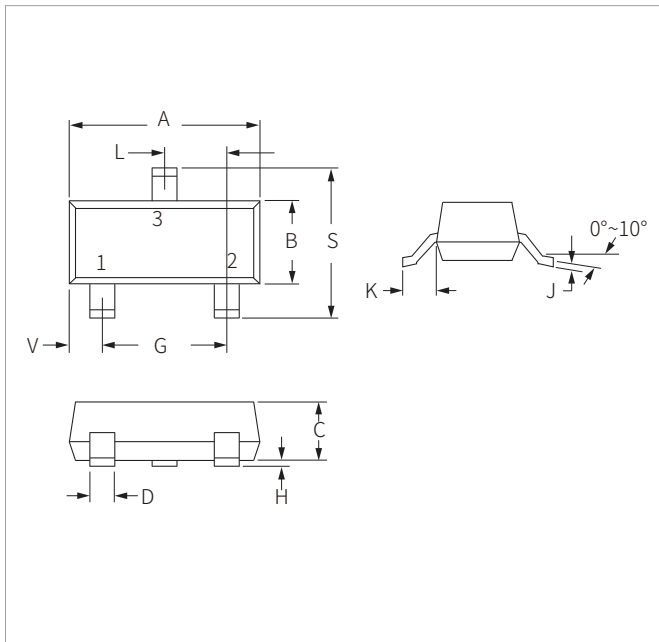

SOT-23 PACKAGE INFORMATION



| Ref. | Millimeters | | Inches | |
|------|-------------|-------|--------|-------|
| | Min. | Max. | Min. | Max. |
| A | 2.80 | 3.05 | 0.110 | 0.120 |
| B | 1.20 | 1.40 | 0.047 | 0.055 |
| C | 0.90 | 1.15 | 0.035 | 0.045 |
| D | 0.37 | 0.50 | 0.015 | 0.020 |
| G | 1.75 | 2.05 | 0.069 | 0.081 |
| H | 0.01 | 0.100 | 0.001 | 0.004 |
| J | 0.085 | 0.180 | 0.003 | 0.007 |
| K | 0.35 | 0.69 | 0.014 | 0.029 |
| L | 0.89 | 1.02 | 0.035 | 0.040 |
| S | 2.10 | 2.65 | 0.083 | 0.104 |
| V | 0.45 | 0.60 | 0.018 | 0.024 |

RECOMMENDED PAD LAYOUT DIMENSIONS

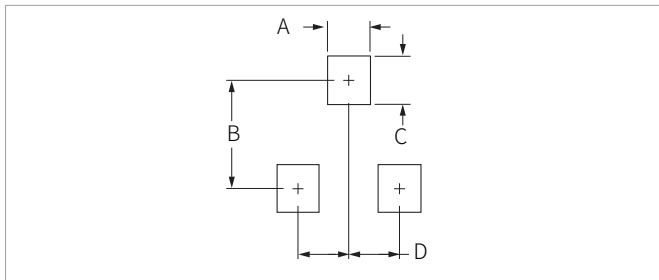

| Ref. | Millimeters | | Inches | |
|------|-------------|------|--------|-------|
| | Min. | Max. | Min. | Max. |
| A | 0.71 | 0.97 | 0.028 | 0.038 |
| B | 1.88 | 2.13 | 0.074 | 0.084 |
| C | 0.71 | 0.97 | 0.028 | 0.038 |
| D | 0.81 | 1.07 | 0.032 | 0.042 |

ORDERING INFORMATION

| Part Number | Component Package | QTY/Reel | Reel Size |
|-------------|-------------------|----------|-----------|
| BAS21A | SOT-23 | 3000PCS | 7" |

Headquarters

No.3387 Shendu Road
Pujiang I&E Park
Minhang Shanghai China
201000

Hotline

400-021-5756

Web

<https://www.semiware.com>

Sales Center

Tel: 86-21-3463-7458
Email: sales18@semiware.com

Customer Service

Tel: 86-21-5484-1001
Email: sales17@semiware.com

Technical Support

Tel: 86-21-3463-7654
Email: fae01@semiware.com

Complaint & Suggestions

Tel: 86-21-3463-7172
Ext: 8868
Email: cs03@semiware.com

By QR Code

Website



Wechat

To find your local partner within Semiware' s global website: www.semiware.com

© 2022 Semiware Semiconductor Inc.

The content of this document has been carefully checked and understood. However, neither Semiware nor its subsidiaries assume any liability whatsoever for any errors or inaccuracies of this document and the consequences thereof. Published specifications are subject to change without notice. Product suitability for any area of application must ultimately be determined by the customer. In all cases, products must never be operated outside their published specifications. Semiware does not guarantee the availability of all published products. This disclaimer shall be governed by substantive Chinese law and resulting disputes shall be settled by the courts at the place of business of Semiware. Latest publications and a complete disclaimer can be downloaded from the Semiware website. All trademarks recognized.