

FEATURES

- | Glass Passivated Chip Junction
- | Ideal For Automated Placement
- | Fast Switching For High Efficiency
- | High Surge Current Capability

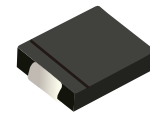

DO-214AB(SMC)

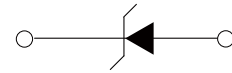

Schematic Symbol

APPLICATIONS

- | Switching Mode Power Supply (SMPS)
- | Adapters
- | Lighting Application
- | Converter

APPROVALS

RoHS	Compliance with 2011/65/EU
HF	Compliance with IEC61249-2-21:2003

MAXIMUM RATINGS AND CHARACTERISTICS (T_A=25°C)

Parameter	Symbol	GS5A	GS5B	GS5D	GS5G	GS5J	GS5K	GS5M	Unit
Marking		GS5A	GS5B	GS5D	GS5G	GS5J	GS5K	GS5M	
Repetitive Peak Reverse Voltage	V _{RRM}	50	100	200	400	600	800	1000	
Reverse Voltage, Total Rms Value	V _{R(RMS)}	35	70	140	280	420	560	700	V
Maximum Dc Blocking Voltage	V _{DC}	50	100	200	400	600	800	1000	
Forward Current	I _{F(AV)}	5							A
Surge Peak Forward Current, 8.3ms Single Half Sine-wave Superimposed On Rated Load Per Diode	I _{FSM}	100							
Forward Voltage Per Diode I _f =5a, t _j =25°C ⁽¹⁾	V _F	1.15							V
Reverse Current @ Rated V _r Per Diode ⁽²⁾	T _J =25°C	10							μA
	T _J =125°C	250							
Reverse Recovery Time I _f =0.5a, I _r =1.0a, i _{rr} =0.25a	T _{rr}	1500							ns
Junction-to-lead Thermal Resistance Per Diode	R _{θJL}	13							°C/W
Junction-to-ambient Thermal Resistance Per Diode	R _{θJA}	47							°C/W
Operating Junction And Storage Temperature Range	T _J , T _{STG}	-55 to +150							°C

Note :

1. Pulse test with PW=0.3 ms
2. Pulse test with PW=30 ms

CHARACTERISTIC CURVES

Fig. 1- Forward Current Derating Curve

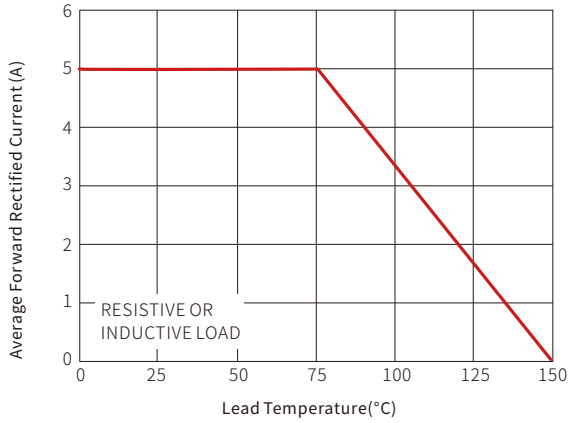

Fig. 2-Typical Reverse Characteristics

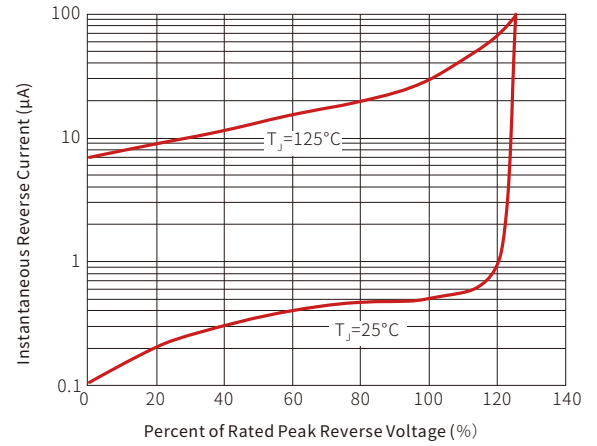

Fig. 3-Typical Junction Capacitance

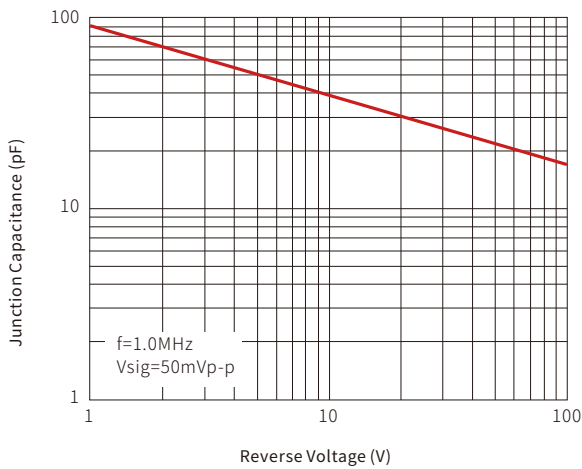

Fig. 4-Typical Forward Characteristics

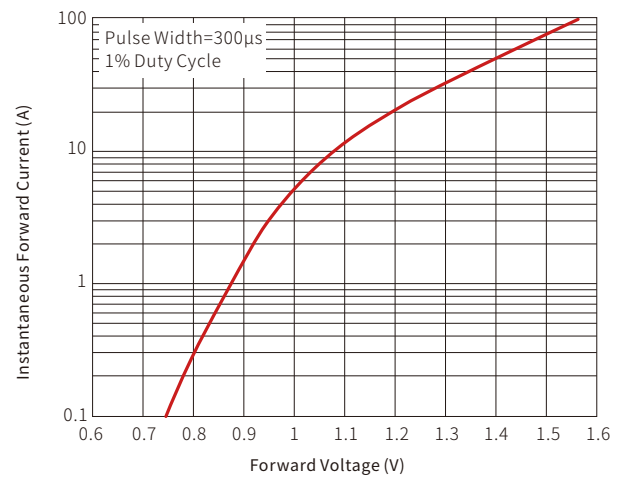

Fig. 5- Maximum Non-repetitive Forward Surge Current

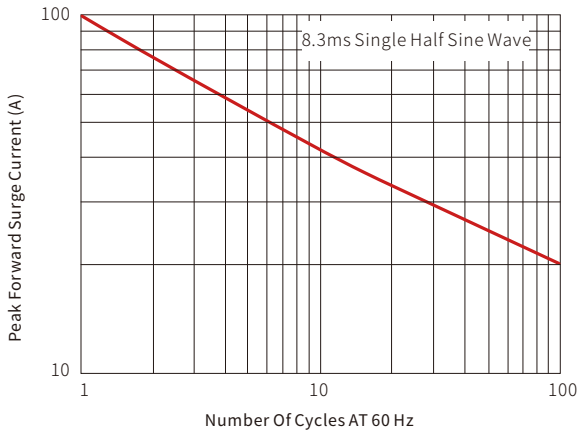
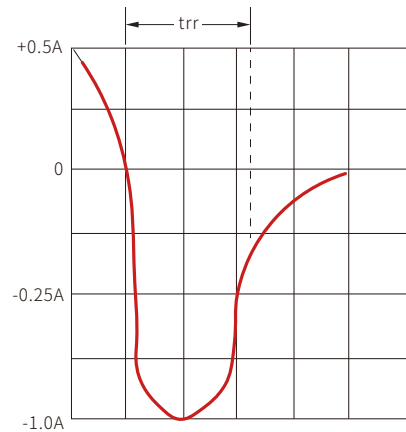
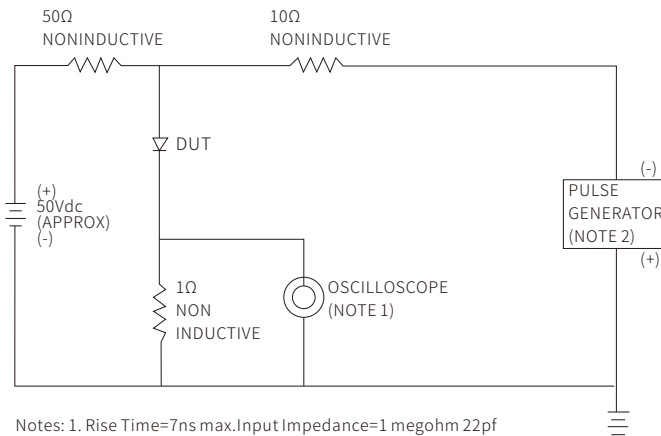
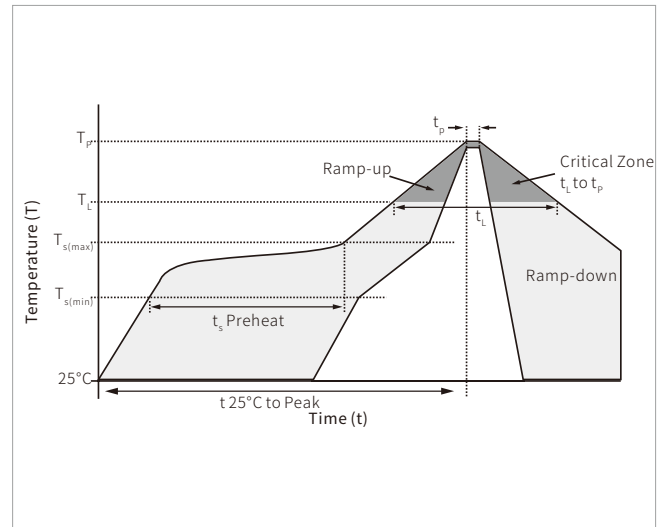

Fig. 6-Reverse Recovery Time Characteristic And Test Circuit Diagram



SOLDERING PARAMETERS

Reflow Condition		Lead-free assembly
Pre Heat	Temperature Max ($T_{s(min)}$)	150°C
	Temperature Max ($T_{s(max)}$)	200°C
	Time (min to max) (t_s)	60 – 180 secs
Average ramp up rate (Liquidus Temp (T_L) to peak		3°C/second max
$T_{s(max)}$ to T_L - Ramp-up Rate		3°C/second max
Reflow	Temperature (T_L) (Liquidus)	217°C
	Time (min to max) (t_L)	60 – 150 seconds
Peak Temperature (T_p)		260°C
Time within 5°C of actual peak Temperature (t_p)		20 – 40 seconds
Ramp-down Rate		6°C/second max
Time 25°C to peak Temperature (T_p)		8 minutes max.
Do not exceed		260°C



DO-214AB(SMC) PACKAGE INFORMATION

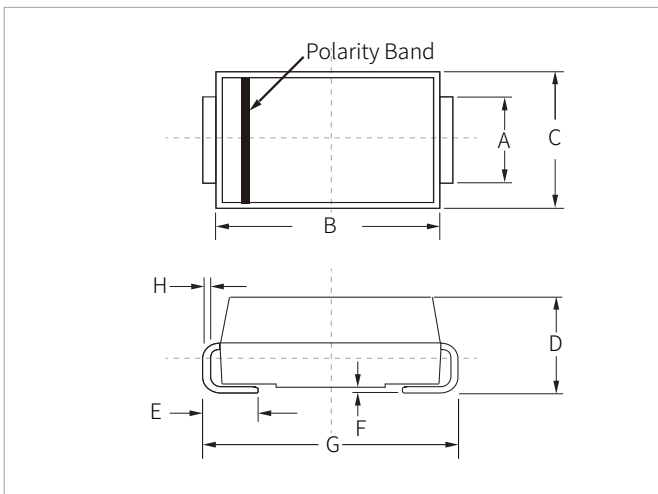

Ref.	Millimeters		Inches	
	Min.	Max.	Min.	Max.
A	2.80	3.20	0.110	0.126
B	6.60	7.20	0.260	0.283
C	5.70	6.10	0.224	0.240
D	2.15	2.75	0.085	0.108
E	1.00	1.60	0.039	0.063
F	0.02	0.20	0.000	0.008
G	7.60	8.00	0.299	0.315
H	0.15	0.30	0.006	0.012

RECOMMENDED PAD LAYOUT DIMENSIONS

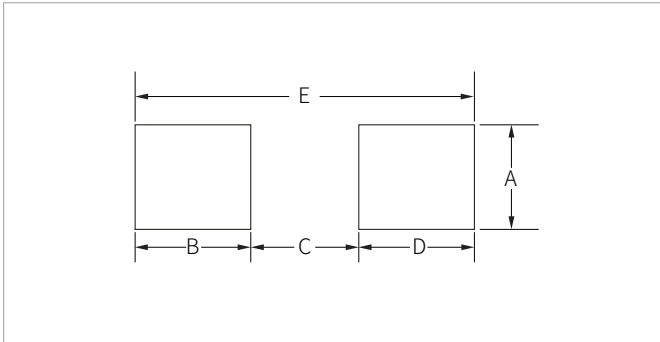

Ref.	Millimeters		Inches	
	Min.	Max.	Min.	Max.
A	3.30	-	0.129	-
B	2.40	-	0.094	-
C	-	4.20	-	0.165
D	2.40	-	0.094	-
E	8.20REF		0.323REF	

ORDERING INFORMATION

Part Number	Component Package	QTY/Reel	Reel Size
GS5A-GS5M	DO-214AB(SMC)	3000PCS	13"

Headquarters

No.3387 Shendu Road
Pujiang I&E Park
Minhang Shanghai China
201000

Hotline

400-021-5756

Web

<https://www.semiware.com>

Sales Center

Tel: 86-21-3463-7458
Email: sales18@semiware.com

Customer Service

Tel: 86-21-5484-1001
Email: sales17@semiware.com

Technical Support

Tel: 86-21-3463-7654
Email: fae01@semiware.com

Complaint & Suggestions

Tel: 86-21-3463-7172
Ext: 8868
Email: cs03@semiware.com

By QR Code

Website



Wechat

To find your local partner within Semiware's global website: www.semiware.com

© 2022 Semiware Semiconductor Inc.

The content of this document has been carefully checked and understood. However, neither Semiware nor its subsidiaries assume any liability whatsoever for any errors or inaccuracies of this document and the consequences thereof. Published specifications are subject to change without notice. Product suitability for any area of application must ultimately be determined by the customer. In all cases, products must never be operated outside their published specifications. Semiware does not guarantee the availability of all published products. This disclaimer shall be governed by substantive Chinese law and resulting disputes shall be settled by the courts at the place of business of Semiware. Latest publications and a complete disclaimer can be downloaded from the Semiware website. All trademarks recognized.