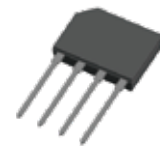
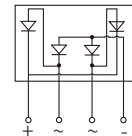

## FEATURES

- | Low Profile Package
- | Idea For Printed Circuit Board
- | Glass Passivated Junction Chip
- | High Forward Surge Current Capability
- | Low Reverse Leakage

**KBP**

Schematic Symbol

## MECHANICAL DATA

- | Case Material: Molded Plastic. UL Flammability Classification Rating 94V-0
- | Moisture Sensitivity: Level 1 Per J-STD-020

## APPROVALS

- |             |                                    |
|-------------|------------------------------------|
| <b>RoHS</b> | Compliance with 2011/65/EU         |
| <b>HF</b>   | Compliance with IEC61249-2-21:2003 |

## MAXIMUM RATINGS AND CHARACTERISTICS (T<sub>A</sub>=25°C)

Parameter	Symbol	KBP2005	KBP201	KBP202	KBP204	KBP206	KBP208	KBP210	Unit
Marking		KBP2005	KBP201	KBP202	KBP204	KBP206	KBP208	KBP210	
Maximum repetitive peak reverse voltage	V <sub>RRM</sub>	50	100	200	400	600	800	1000	V
Maximum RMS voltage	V <sub>RMS</sub>	35	70	140	280	420	560	700	v
Maximum DC blocking voltage	V <sub>DC</sub>	50	100	200	400	600	800	1000	V
Average rectified output current @60Hz sine wave, R-load, T <sub>c</sub> =122°C	I <sub>o</sub>				2.0				A
Forward Surge Current (Non-repetitive) @60Hz Half-sine wave, 1 cycle, T <sub>j</sub> =25°C	I <sub>FSM</sub>				60				A
Forward Surge Current (Non-repetitive) @1ms, square wave, 1 cycle, T <sub>j</sub> =25°C					120				A
Current squared time @1ms ≤ t ≤ 8.3ms T <sub>j</sub> =25°C, Rating of per diode	I <sup>2</sup> t				15				A <sup>2</sup> s
Dielectric strength @ terminals to case, AC 1 minut	V <sub>dis</sub>				2				KV
Maximum instantaneous forward voltage drop per diode I <sub>FM</sub> =1.0A	V <sub>F</sub>				1.0				V
Maximum DC reverse current at rated DC blocking voltage per diode	I <sub>R</sub>				5				μA
					100				μA
Typical junction capacitance Measured at 1MHz and Applied Reverse Voltage of 4.0 V.D.C	C <sub>j</sub>				26				pF
Thermal Resistance Between junction and ambient	R <sub>θJ-A</sub>				45				°C/W
Thermal Resistance Between junction and Case	R <sub>θJ-C</sub>				7				°C/W
Operating junction and storage temperature rang	T <sub>J</sub> , T <sub>STG</sub>				-55 ~ +150				°C

# CHARACTERISTIC CURVES

Fig. 1- I<sub>o</sub>-T<sub>c</sub> Curve

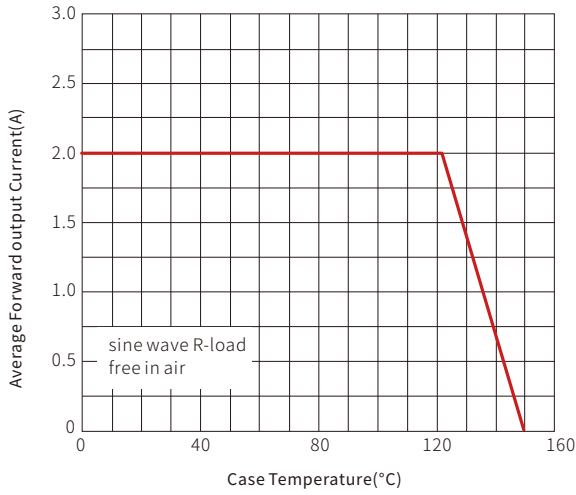

Fig. 2-Surge Forward Current Capability

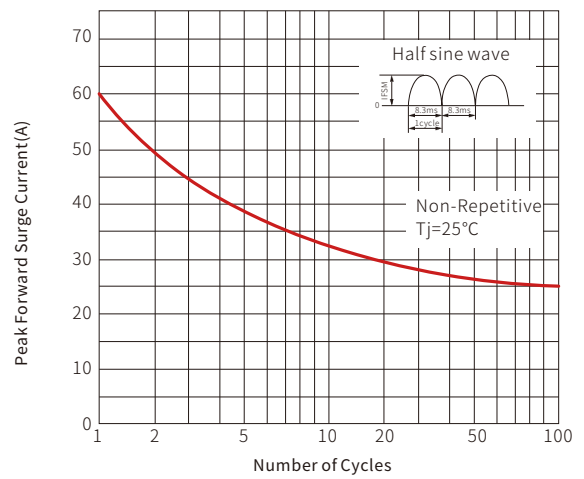

Fig. 3-Typical Forward Voltage

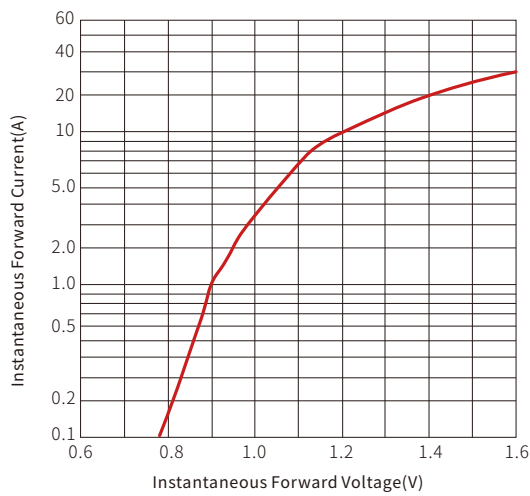
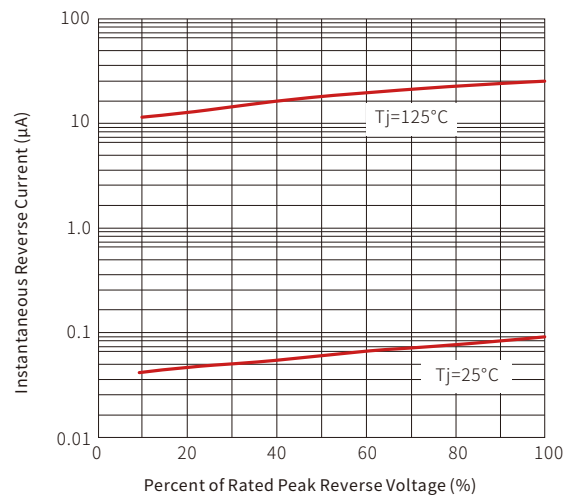
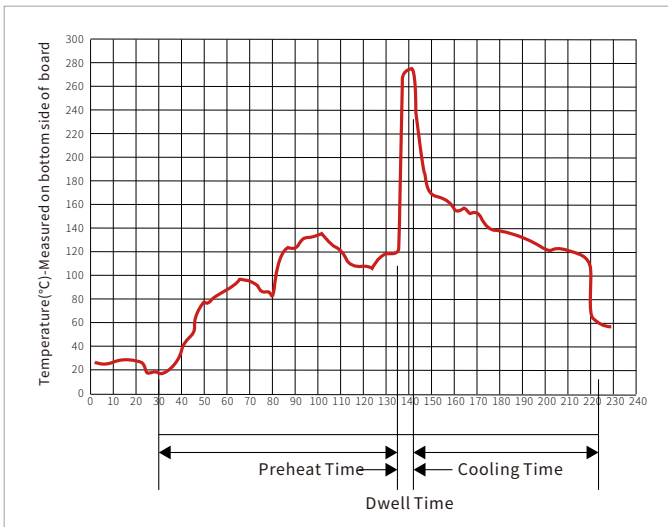

Fig. 4-Typical Reverse Characteristics



## WAVE SOLDERING



Wave Parameter		Lead-free assembly
Pre Heat	Temperature Min	100°C
	Temperature Max	150°C
	Time(min to max)	60 – 180 secs
Solder pot Temperature		280°C Max
Solder Dwell Time		2-5 seconds

## KBP PACKAGE INFORMATION

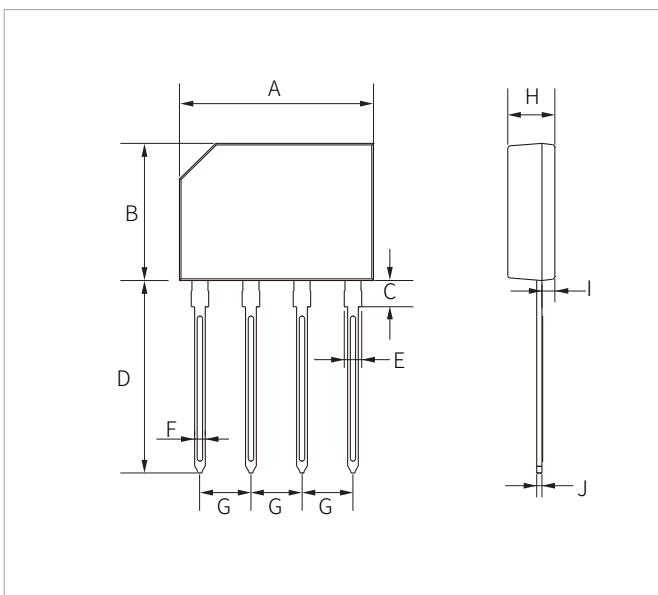

Ref.	Millimeters		Inches	
	Min.	Max.	Min.	Max.
A	14.25	14.75	0.561	0.581
B	10.10	10.60	0.398	0.417
C	1.80	2.20	0.071	0.087
D	14.25	14.73	0.561	0.580
E	1.22	1.42	0.048	0.056
F	0.76	0.86	0.030	0.034
G	3.70	3.90	0.146	0.153
H	3.35	3.65	0.132	0.144
I	0.80	1.10	0.031	0.043
J	0.35	0.55	0.014	0.022

## ORDERING INFORMATION

Part Number	Component Package	Per Box	Description
KBP2005-KBP210	KBP	500PCS	Box

**Headquarters**

No.3387 Shendu Road  
Pujiang I&E Park  
Minhang Shanghai China  
201000

**Hotline**

400-021-5756

**Web**

<https://www.semiware.com>

**Sales Center**

Tel: 86-21-3463-7458  
Email: [sales18@semiware.com](mailto:sales18@semiware.com)

**Customer Service**

Tel: 86-21-5484-1001  
Email: [sales17@semiware.com](mailto:sales17@semiware.com)

**Technical Support**

Tel: 86-21-3463-7654  
Email: [fae01@semiware.com](mailto:fae01@semiware.com)

**Complaint & Suggestions**

Tel: 86-21-3463-7172  
Ext: 8868  
Email: [cs03@semiware.com](mailto:cs03@semiware.com)

**By QR Code**

Website



Wechat

To find your local partner within Semiware's global website: [www.semiware.com](http://www.semiware.com)

© 2022 Semiware Semiconductor Inc.

The content of this document has been carefully checked and understood. However, neither Semiware nor its subsidiaries assume any liability whatsoever for any errors or inaccuracies of this document and the consequences thereof. Published specifications are subject to change without notice. Product suitability for any area of application must ultimately be determined by the customer. In all cases, products must never be operated outside their published specifications. Semiware does not guarantee the availability of all published products. This disclaimer shall be governed by substantive Chinese law and resulting disputes shall be settled by the courts at the place of business of Semiware. Latest publications and a complete disclaimer can be downloaded from the Semiware website. All trademarks recognized.