

FEATURES

- | Construction Utilizes Void-free Molded Plastic Technique

- | Low Reverse Leakage

- | High Forward Surge Current Capability

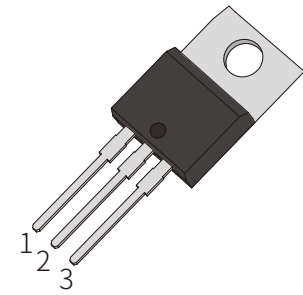

TO-220AB

MECHANICAL DATA

- | Case : Molded Plastic Body

- | Polarity : Polarity Symbol Marking On Body

- | Mounting Position : Any

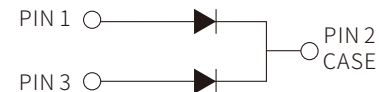

Schematic Symbol

APPROVALS

RoHS	Compliance with 2011/65/EU
HF	Compliance with IEC61249-2-21:2003

MAXIMUM RATINGS ($T_A=25^{\circ}\text{C}$)

Parameter	Symbol	MBR 4040CT	MBR 4045CT	MBR 4060CT	MBR 40100CT	MBR 40150CT	MBR 40200CT	Unit
Marking		MBR 4040CT	MBR 4045CT	MBR 4060CT	MBR 40100CT	MBR 40150CT	MBR 40200CT	
Maximum Repetitive Peak Reverse Voltage	V_{RRM}	40	45	60	100	150	200	V
Maximum RMS Voltage	V_{RMS}	28	31.5	42	70	105	140	V
Maximum DC Blocking Voltage	V_{DC}	40	45	60	100	150	200	V
Maximum Average Forward Rectified Current at $T_c=110^{\circ}\text{C}$	per device	40.0						A
	per diode	20.0						
Peak Forward Surge Current, 8.3ms Single Half Sine-wave Superimposed On Rated Load	I_{FSM}	250.0						A
Maximum Instantaneous Forward Voltage per Diode at 20.0A	V_F	0.65	0.75	0.85	0.95		V	
Maximum DC Reverse Current at Rated DC Blocking Voltage	$T_A=25^{\circ}\text{C}$	0.5			0.05		mA	
	$T_A=125^{\circ}\text{C}$	50			10		mA	
Typical Thermal Resistance	$R_{\theta JC}$	3.5						$^{\circ}\text{C}/\text{W}$
Operating Junction Temperature Range	T_J	-55 to +150						$^{\circ}\text{C}$
Storage Temperature Range	T_{STG}	-55 to +150						$^{\circ}\text{C}$

CHARACTERISTIC CURVES

Fig. 1- Derating Curve Output Rectified Current

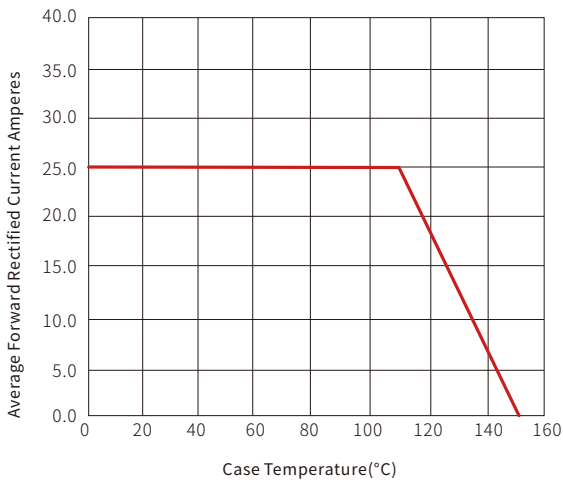

Fig. 2- Maximum Non-Repetitive Peak Forward Surge Current Perleg

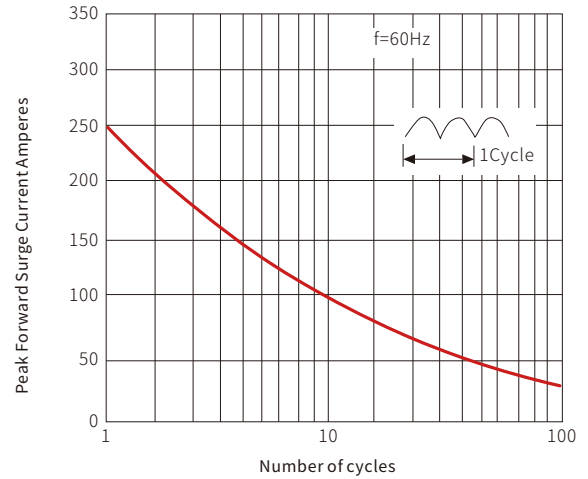

Fig. 3- Typical Forward Voltage Characteristics

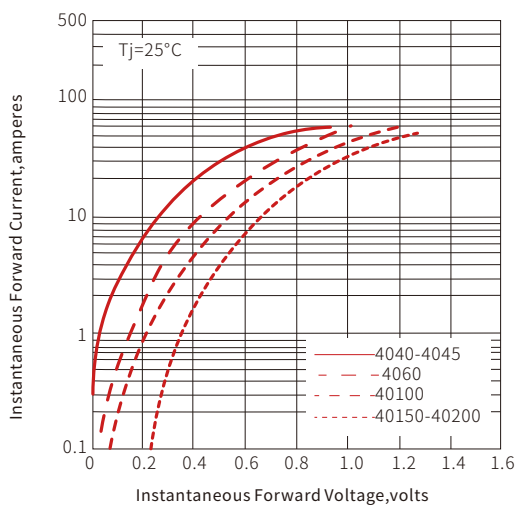
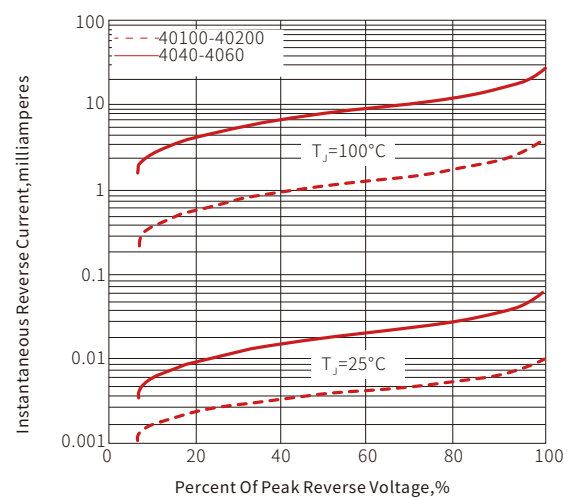
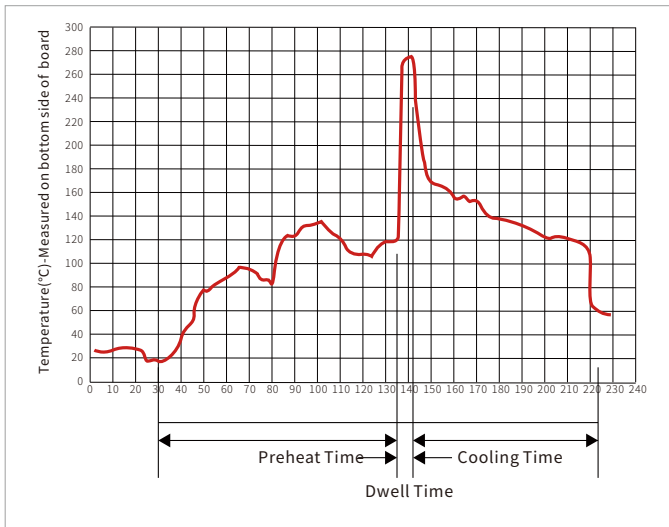

Fig. 4- Typical Reverse Leakage Characteristics



WAVE SOLDERING



Wave Parameter		Lead-free assembly
Pre Heat	Temperature Min	100°C
	Temperature Max	150°C
	Time(min to max)	60 – 180 secs
Solder pot Temperature		280°C Max
Solder Dwell Time		2-5 seconds

TO-220AB PACKAGE MECHANICAL DATA

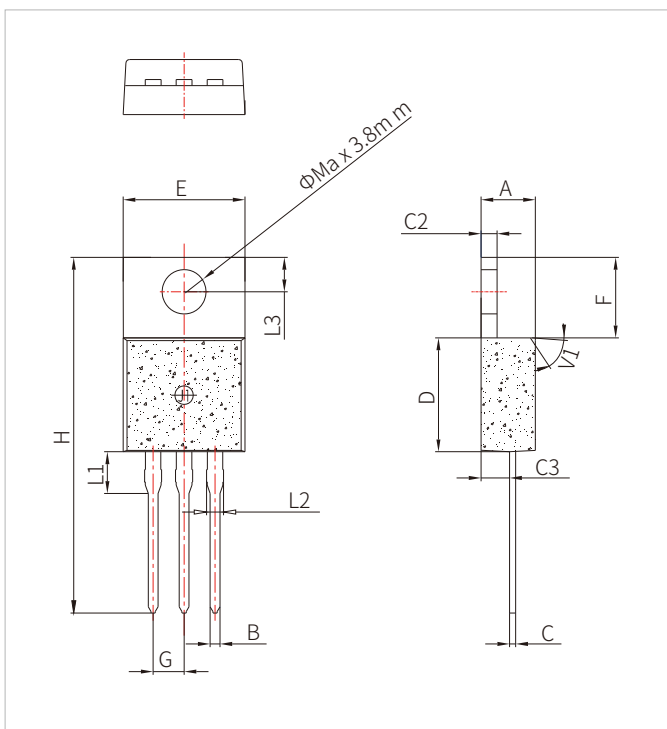

Ref.	Dimensions					
	Millimeters			Inches		
	Min.	Typ.	Max.	Min.	Typ.	Max.
A	4.40		4.60	0.173		0.181
B	0.61		0.88	0.024		0.035
C	0.46		0.70	0.018		0.028
C2	1.21		1.32	0.048		0.052
C3	2.40		2.72	0.094		0.107
D	8.60		9.70	0.339		0.382
E	9.80		10.4	0.386		0.409
F	6.55		6.95	0.258		0.274
G		2.54			0.1	
H	28.0		29.8	1.102		1.173
L1		3.75			0.148	
L2	1.14		1.70	0.045		0.067
L3	2.65		2.95	0.104		0.116
V1		45°			45°	

ORDERING INFORMATION

Part Number	Component Package	QTY/Tube	QTY/Box	QTY/Carton
MBR4040CT-MBR40200CT	TO-220AB	50PCS	1000PCS	5000PCS

Headquarters

No.3387 Shendu Road
Pujiang I&E Park
Minhang Shanghai China
201000

Hotline

400-021-5756

Web

<https://www.semiware.com>

Sales Center

Tel: 86-21-3463-7458
Email: sales18@semiware.com

Customer Service

Tel: 86-21-5484-1001
Email: sales17@semiware.com

Technical Support

Tel: 86-21-3463-7654
Email: fae01@semiware.com

Complaint & Suggestions

Tel: 86-21-3463-7172
Ext: 8868
Email: cs03@semiware.com

By QR Code

Website



Wechat

To find your local partner within Semiware' s global website: www.semiware.com

© 2022 Semiware Semiconductor Inc.

The content of this document has been carefully checked and understood. However, neither Semiware nor its subsidiaries assume any liability whatsoever for any errors or inaccuracies of this document and the consequences thereof. Published specifications are subject to change without notice. Product suitability for any area of application must ultimately be determined by the customer. In all cases, products must never be operated outside their published specifications. Semiware does not guarantee the availability of all published products. This disclaimer shall be governed by substantive Chinese law and resulting disputes shall be settled by the courts at the place of business of Semiware. Latest publications and a complete disclaimer can be downloaded from the Semiware website. All trademarks recognized.