

FEATURES

- Low current, Low voltage
- Meet AEC-Q101 Requirements



MECHANICAL DATA

- General purpose amplifier and switching
- Meet the stringent requirements of automotive applications



APPROVALS

RoHS	Compliance with 2011/65/EU
HF	Compliance with IEC61249-2-21:2003

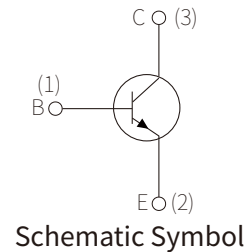

MAXIMUM RATINGS (T_A = 25°C)

Parameter	Symbol	Value	Unit
Collector to Base Voltage	V _{CBO}	60	V
Collector to Emitter Voltage	V _{CEO}	40	
Emitter to Base Voltage	V _{EBO}	6.0	
Collector Current	I _C	200	mA
Collector Power Dissipation	P _C	200	mW
	*P _C	350	
Junction Temperature	T _J	150	°C
Storage Temperature Range	T _{STG}	-55~+150	°C

* When mounted on a 7×5×0.6mm ceramic board

ELECTRICAL CHARACTERISTICS (T_A=25°C)

Parameter	Symbol	Test Conditions	Min.	Typ.	Max.	Unit
Collector to Base Breakdown Voltage	V _{CBO}	I _C =10μA, I _E =0	60			V
Collector to Emitter Breakdown Voltage	V _{CEO}	I _C =1.0mA, I _B =0	40			
Emitter to Base Breakdown Voltage	V _{EBO}	I _E =10μA, I _C =0	6.0			
Collector Cut-Off Current	I _{CBO}	V _{CB} =30V, I _E =0			0.05	μA
Emitter Cut-Off Current	I _{EBO}	V _{EB} =3.0V, I _C =0			0.05	
DC current gain	h _{FE(1)}	V _{CE} =1.0V, I _C =10mA	100		300	
	h _{FE(2)}	V _{CE} =1.0V, I _C =100mA	30			
	h _{FE(3)}	V _{CE} =1.0V, I _C =50mA	60			
	h _{FE(4)}	V _{CE} =1.0V, I _C =1.0mA	70			
	h _{FE(5)}	V _{CE} =1.0V, I _C =0.1mA	40			
Collector-emitter saturation voltage	V _{CE(sat)1}	I _C =10mA, I _B =1.0mA			0.2	V
	V _{CE(sat)2}	I _C =50mA, I _B =5.0mA			0.3	
Base-emitter saturation voltage	V _{BE(sat)1}	I _C =10mA, I _B =1.0mA	0.65		0.85	
	V _{BE(sat)2}	I _C =50mA, I _B =5.0mA			0.95	
Transition frequency	f _T	V _{CE} =20V, I _C =10mA, f=100MHz	300			MHz
Output Capacitance	C _{ob}	V _{CB} =5.0V f=1.0MHz			4.0	pF
Input Capacitance	C _{ib}	V _{EB} =0.5V f=1.0MHz			8.0	pF
Delay time	td	V _{CC} =3.0V, V _{BE} =0.5V I _C =10mA, I _{B1} =1.0mA			35	nS
Rise Time	tr				35	
Storage time	tstg				200	
Fall time	tf	V _{CC} =3.0V, I _C =10mA, I _{B1} =-I _{B2} =1.0mA			50	

TYPICAL CHARACTERISTICS

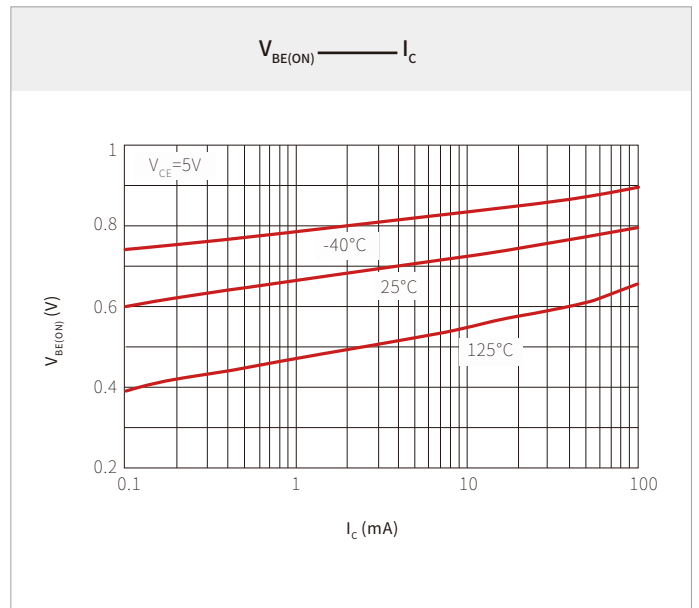
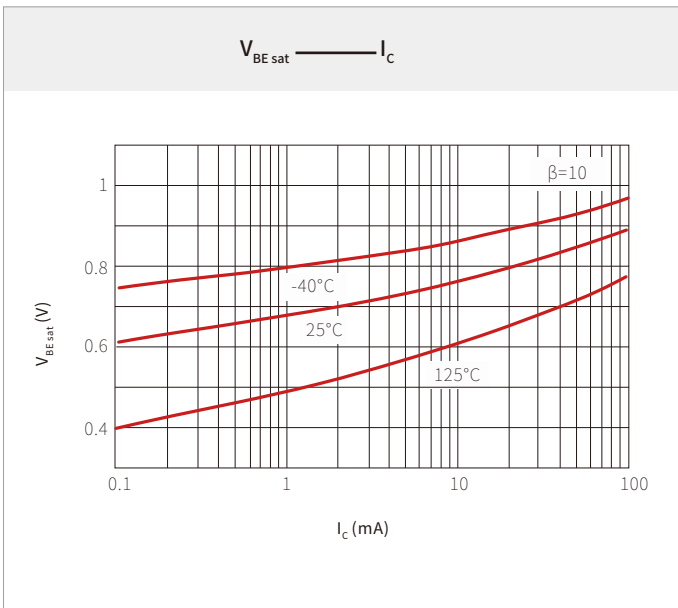
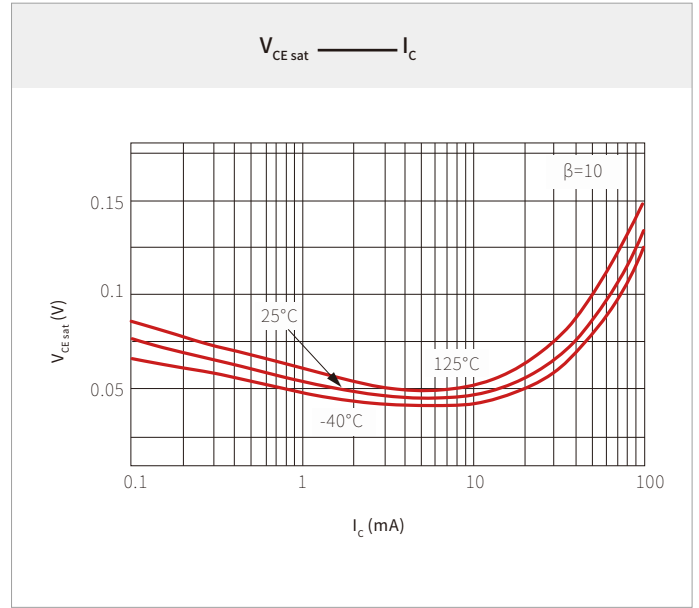
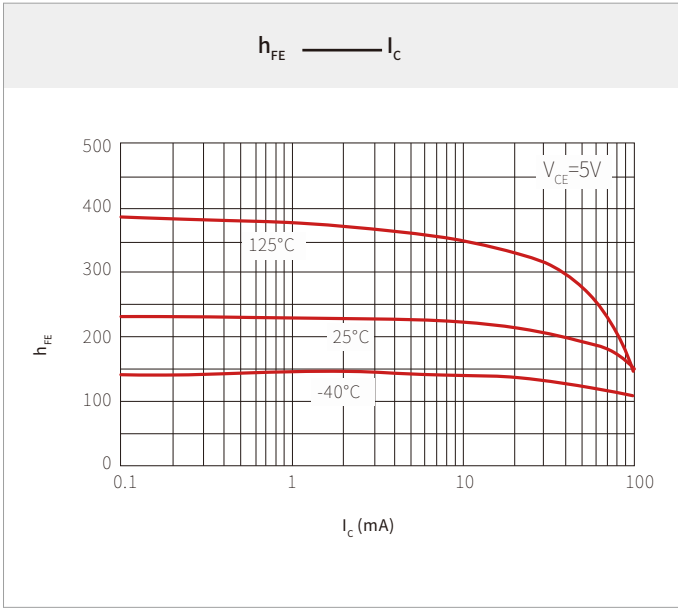

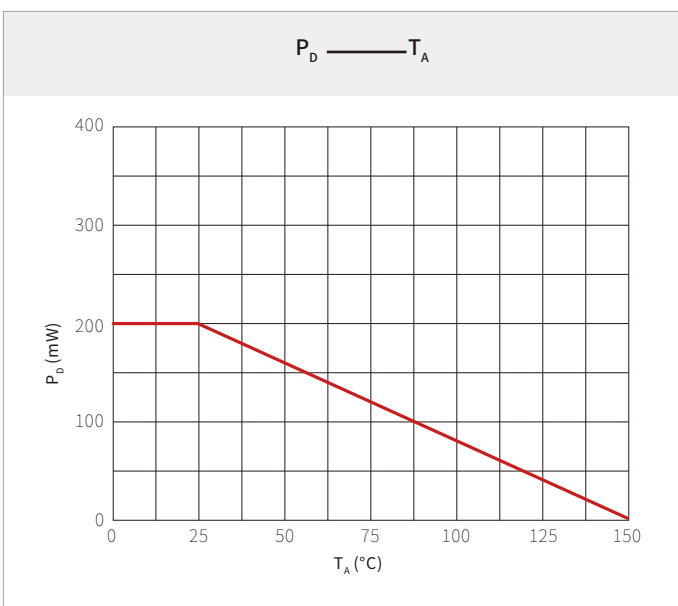
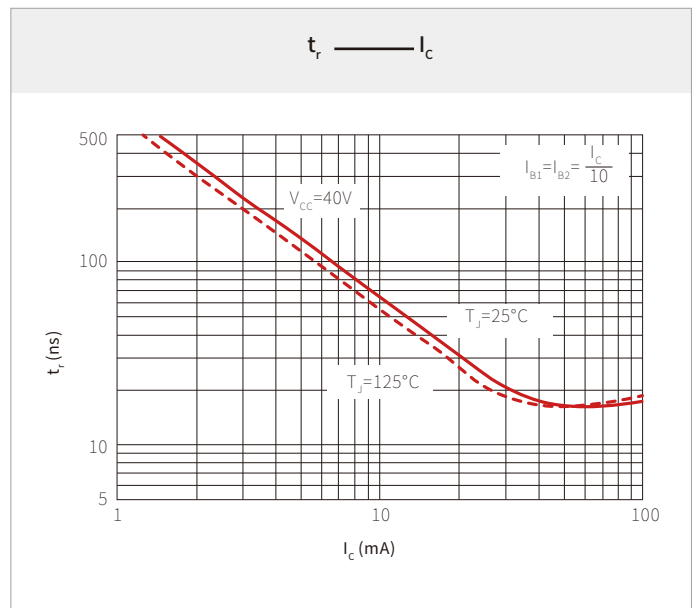
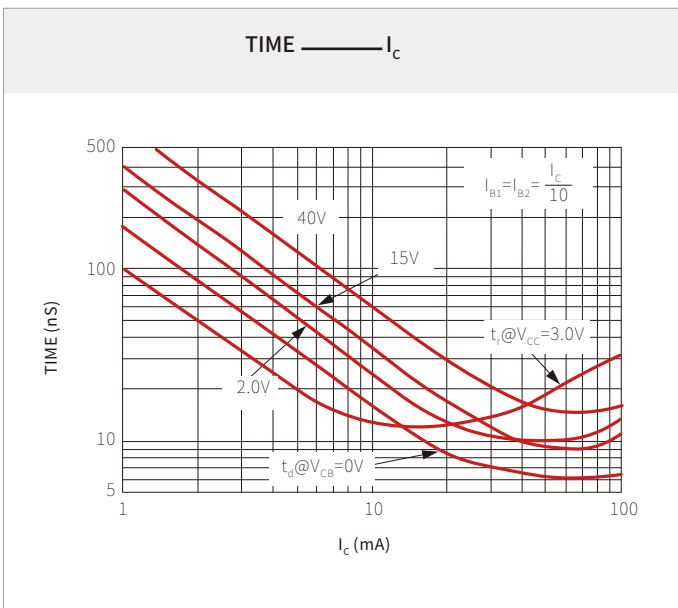
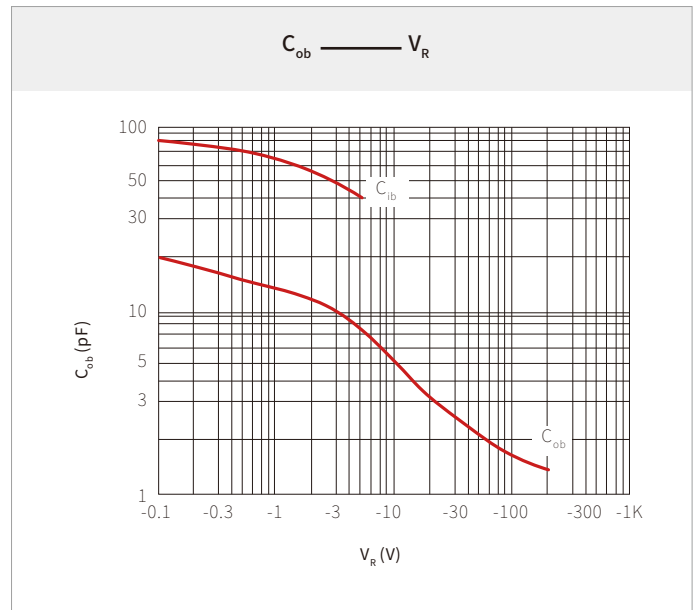
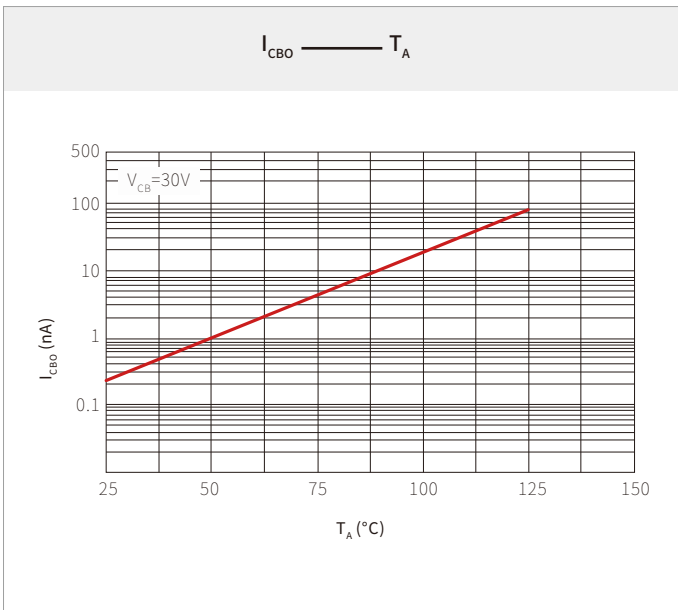

SOT-23 PACKAGE INFORMATION

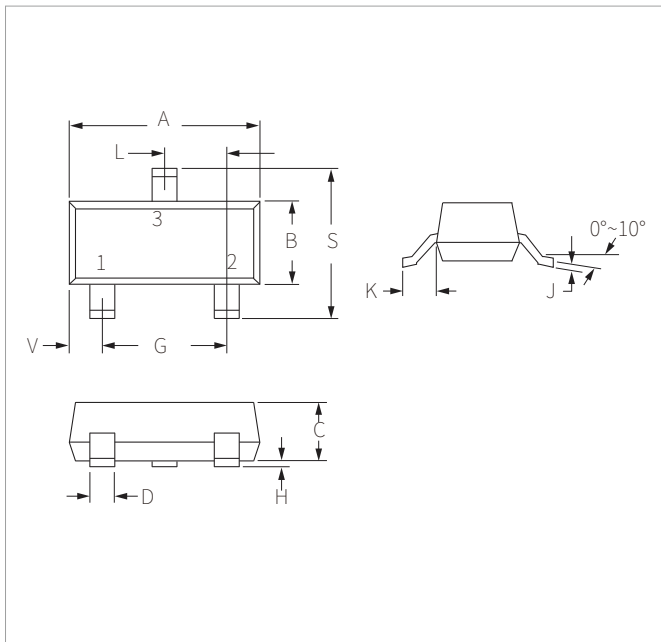

Ref.	Millimeters		Inches	
	Min.	Max.	Min.	Max.
A	2.80	3.04	0.110	0.120
B	1.20	1.40	0.047	0.055
C	0.89	1.11	0.035	0.044
D	0.37	0.50	0.015	0.020
G	1.78	2.04	0.070	0.081
H	0.01	0.100	0.001	0.004
J	0.085	0.180	0.003	0.007
K	0.35	0.69	0.014	0.029
L	0.89	1.02	0.035	0.040
S	2.10	2.64	0.083	0.104
V	0.45	0.60	0.018	0.024

RECOMMENDED PAD LAYOUT DIMENSIONS

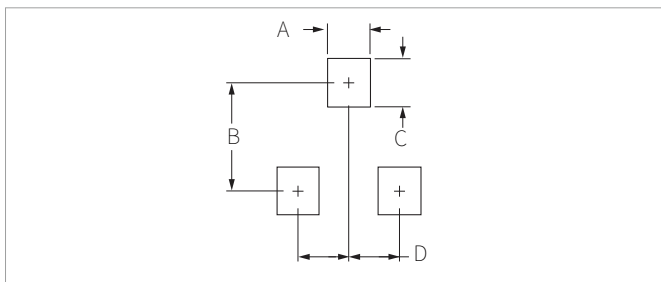

Ref.	Millimeters		Inches	
	Min.	Max.	Min.	Max.
A	0.71	0.97	0.028	0.038
B	1.88	2.13	0.074	0.084
C	0.71	0.97	0.028	0.038
D	0.81	1.07	0.032	0.042

ORDERING INFORMATION

Part Number	Component Package	QTY/Reel	Reel Size
MMBT3904Q	SOT-23	3000PCS	7"

Headquarters

No.3387 Shendu Road
Pujiang I&E Park
Minhang Shanghai China
201000

Hotline

400-021-5756

Web

<https://www.semiware.com>

Sales Center

Tel: 86-21-3463-7458
Email: sales18@semiware.com

Customer Service

Tel: 86-21-5484-1001
Email: sales17@semiware.com

Technical Support

Tel: 86-21-3463-7654
Email: fae01@semiware.com

Complaint & Suggestions

Tel: 86-21-3463-7172
Ext: 8868
Email: cs03@semiware.com

By QR Code

Website



Wechat

To find your local partner within Semiware' s global network: www.semiware.com

© 2022 Semiware Semiconductor Inc.

The content of this document has been carefully checked and understood. However, neither Semiware nor its subsidiaries assume any liability whatsoever for any errors or inaccuracies of this document and the consequences thereof. Published specifications are subject to change without notice. Product suitability for any area of application must ultimately be determined by the customer. In all cases, products must never be operated outside their published specifications. Semiware does not guarantee the availability of all published products. This disclaimer shall be governed by substantive Chinese law and resulting disputes shall be settled by the courts at the place of business of Semiware. Latest publications and a complete disclaimer can be downloaded from the Semiware website. All trademarks recognized.