

FEATURES

- | Excellent capability of absorbing transient surge
- | Quick response to surge voltage
- | Eliminates over voltage caused by fast rising transients
- | Solid-state silicon technology, non degenerate



SOD-123FL



Marking



Schematic Symbol

APPLICATIONS

- | Audio/Video line
- | Network and telecom
- | Data lines and security systems
- | Serial ports

APPROVALS

RoHS	Compliance with 2011/65/EU
HF	Compliance with IEC61249-2-21:2003

ELECTRICAL CHARACTERISTICS

Part Number	V_{DRM}	V_S	V_T	I_{DRM}	I_S	I_T	I_H	C_o
	Min. (V)	Max. (V)	Max. (V)	Max. (μA)	mA	Max. (A)	Min. (mA)	Typ.(pF)
P0080FA	6.0	25.0	4.0	5.0	800.0	2.2	40.0	50.0

SURGE RATINGS

Part Number	V_{PP} 10x700us
	(V)
P0080FA	3000

THERMAL CONSIDERATIONS

Symbol	Parameter	Value	Unit
$R_{\theta JA}$	Junction to Ambient on printed circuit	220	°C/W
T_J	Operating Junction Temperature	-55 to +125	°C
T_{STG}	Storage Temperature Range	-55 to +150	°C

RATINGS AND CHARACTERISTIC CURVES ($T_A=25^\circ\text{C}$)

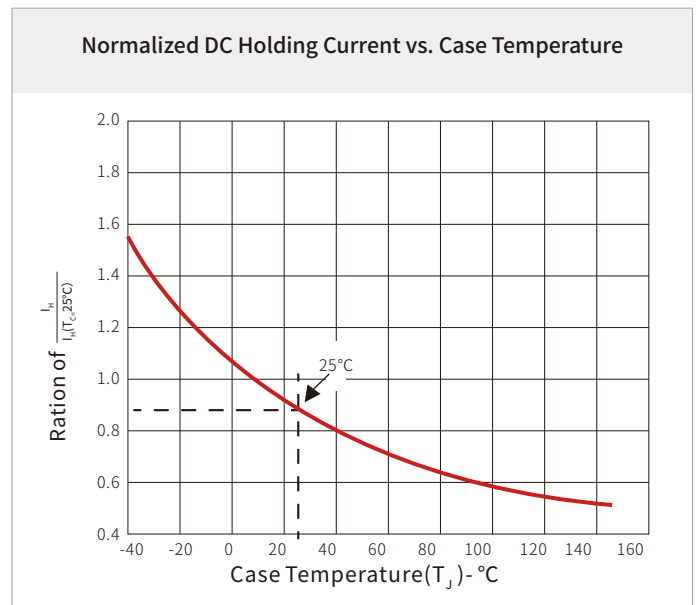
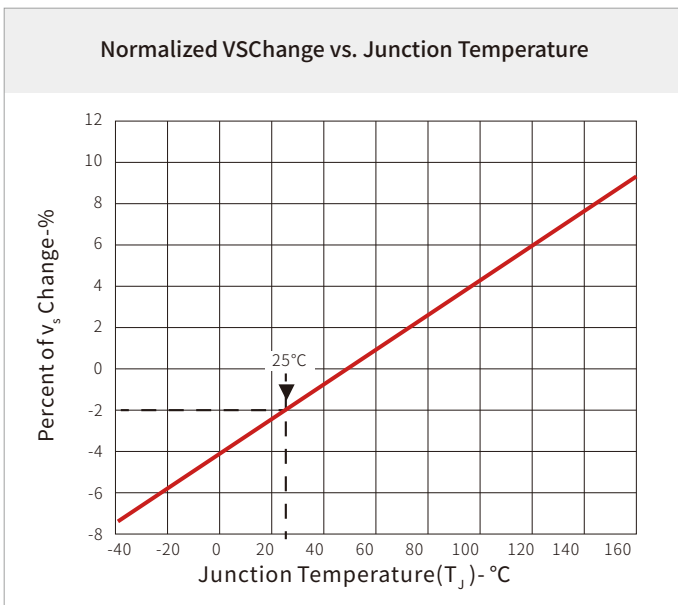
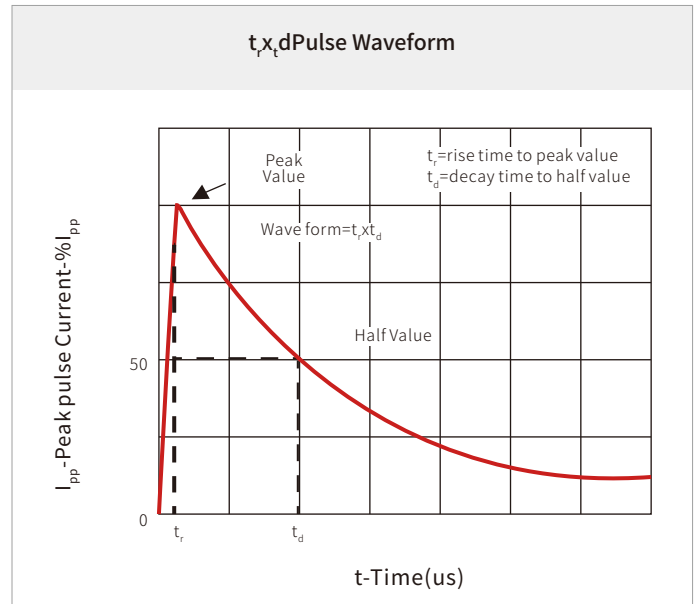
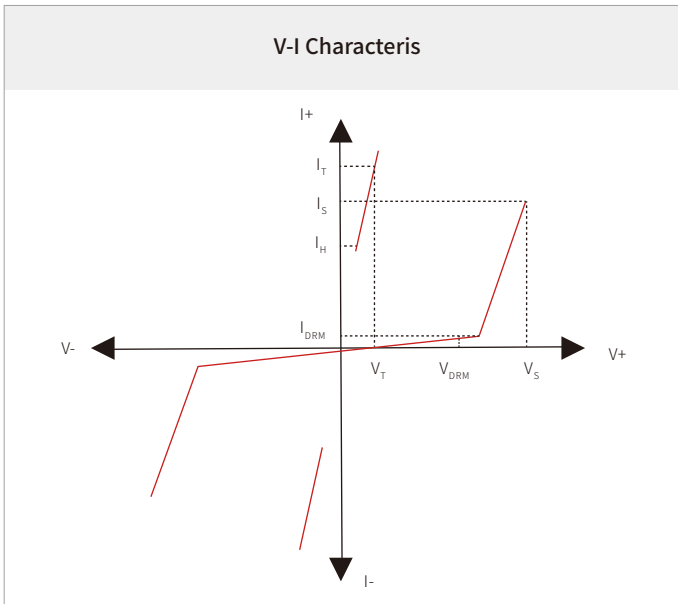

SOLDERING PARAMETERS

Reflow Condition		Lead-free assembly
Pre Heat	Temperature Max ($T_{s(min)}$)	150°C
	Temperature Max ($T_{s(max)}$)	200°C
	Time (min to max) (t_s)	60 – 180 secs
Average ramp up rate (Liquidus Temp (T_L) to peak		3°C/second max
$T_{s(max)}$ to T_L - Ramp-up Rate		3°C/second max
Reflow	Temperature (T_L) (Liquidus)	217°C
	Time (min to max) (t_r)	60 – 150 seconds
Peak Temperature (T_p)		260°C
Time within 5°C of actual peak Temperature (t_p)		20 – 40 seconds
Ramp-down Rate		6°C/second max
Time 25°C to peak Temperature (T_p)		8 minutes max.
Do not exceed		260°C

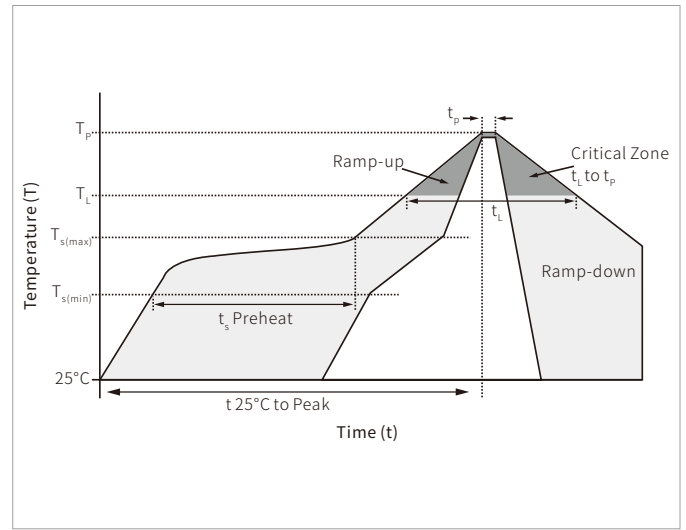

SOD-123FL PACKAGE INFORMATION

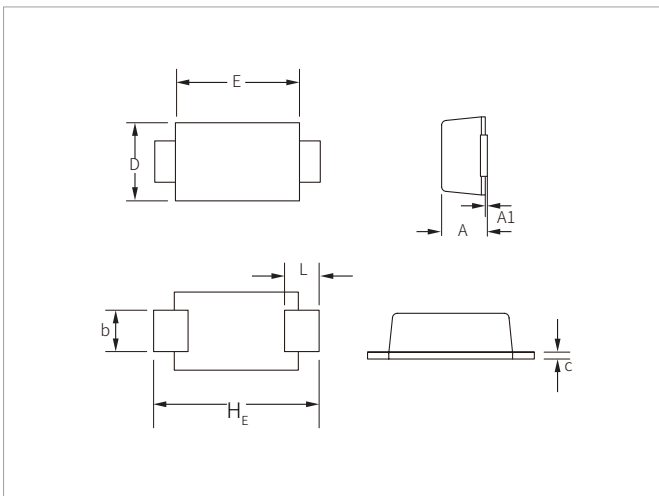

Ref.	Millimeters		Inches	
	Min.	Max.	Min.	Max.
A	0.95	1.45	0.037	0.057
A1	0.00	0.10	0.000	0.004
b	0.70	1.20	0.028	0.047
c	0.05	0.30	0.002	0.012
D	1.50	2.00	0.059	0.079
E	2.50	3.10	0.098	0.122
L	0.35	0.90	0.014	0.035
H _E	3.40	3.90	0.134	0.154

RECOMMENDED PAD LAYOUT DIMENSIONS

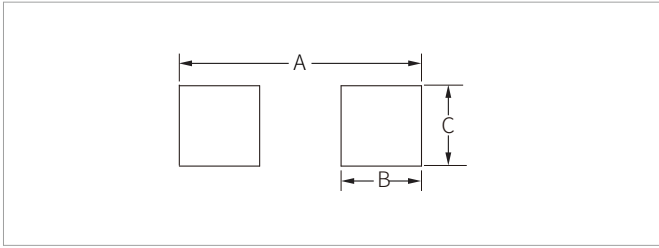

Ref.	Millimeters	Inches
A	4.20	0.165
B	1.50	0.059
C	1.20	0.047

ORDERING INFORMATION

Part Number	Component Package	QTY/Reel	Reel Size
P0080FA	SOD-123FL	3000PCS	7"

Headquarters

No.3387 Shendu Road
Pujiang I&E Park
Minhang Shanghai China
201000

Hotline

400-021-5756

Web

<https://www.semiware.com>

Sales Center

Tel: 86-21-3463-7458
Email: sales18@semiware.com

Customer Service

Tel: 86-21-5484-1001
Email: sales17@semiware.com

Technical Support

Tel: 86-21-3463-7654
Email: fae01@semiware.com

Complaint & Suggestions

Tel: 86-21-3463-7172
Ext: 8868
Email: cs03@semiware.com

By QR Code

Website



Wechat

To find your local partner within Semiware' s global website: www.semiware.com

© 2022 Semiware Semiconductor Inc.

The content of this document has been carefully checked and understood. However, neither Semiware nor its subsidiaries assume any liability whatsoever for any errors or inaccuracies of this document and the consequences thereof. Published specifications are subject to change without notice. Product suitability for any area of application must ultimately be determined by the customer. In all cases, products must never be operated outside their published specifications. Semiware does not guarantee the availability of all published products. This disclaimer shall be governed by substantive Chinese law and resulting disputes shall be settled by the courts at the place of business of Semiware. Latest publications and a complete disclaimer can be downloaded from the Semiware website. All trademarks recognized.