

FEATURES

- | High Collector Current

- | Complementary To S9013

- | Excellent h_{FE} Linearity



MECHANICAL DATA

- | SOT-23 small outline plastic package

- | Epoxy UL: 94V-0

- | Mounting position: Any

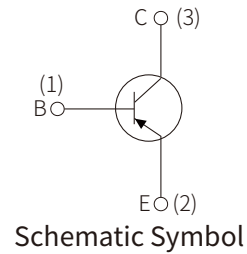
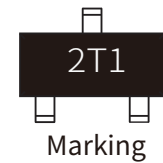

APPROVALS

RoHS	Compliance with 2011/65/EU
HF	Compliance with IEC61249-2-21:2003

MAXIMUM RATINGS ($T_A=25^{\circ}\text{C}$)

Parameter	Symbol	Value	Unit
Collector-Base Voltage	V_{CBO}	-40	V
Collector-Emitter Voltage	V_{CEO}	-25	
Emitter-Base Voltage	V_{EBO}	-5	
Collector Current	I_C	-500	mA
Collector Power Dissipation	P_C	300	mW
Thermal Resistance From Junction To Ambient	$R_{\theta JA}$	416	$^{\circ}\text{C}/\text{W}$
Junction Temperature	T_J	-55~+150	$^{\circ}\text{C}$
Storage Temperature	T_{STG}	-55~+150	$^{\circ}\text{C}$

ELECTRICAL CHARACTERISTICS (T_A=25°C)

Parameter	Symbol	Test Conditions	Min.	Typ.	Max.	Unit
Collector-base breakdown voltage	V _{(BR)CBO}	I _C =-0.1mA, I _E =0	-40			V
Collector-emitter breakdown voltage	V _{(BR)CEO}	I _C =-1mA, I _B =0	-25			
Emitter-base breakdown voltage	V _{(BR)EBO}	I _E =-0.1mA, I _C =0	-5			
Collector cut-off current	I _{CEO}	V _{CE} =-20V, I _B =0			-0.1	uA
Emitter cut-off current	I _{CBO}	V _{CB} =-40V, I _E =0			-0.1	
Emitter cut-off current	I _{EBO}	V _{EB} =-5V, I _C =0			-0.1	
DC current gain	h _{FE}	V _{CE} =-1V, I _C =-50mA	120		400	
Collector-emitter saturation voltage	V _{CE(sat)}	I _C =-500mA, I _B =-50mA			-0.6	V
Base-emitter saturation voltage	V _{BE(sat)}	I _C =-500mA, I _B =-50mA			-1.2	
Transition frequency	f _T	V _{CE} =-6V, I _C =-20mA, f=30MHz	150			MHz
Collector output capacitance	C _{ob}	V _{CB} =-10V, I _E =0, f=1MHz			5	pF

CLASSIFICATION OF H_{FE(1)}

Rank	L	H	J
Range	120-200	200-350	300-400

TYPICAL CHARACTERISTICS

Static Characteristic

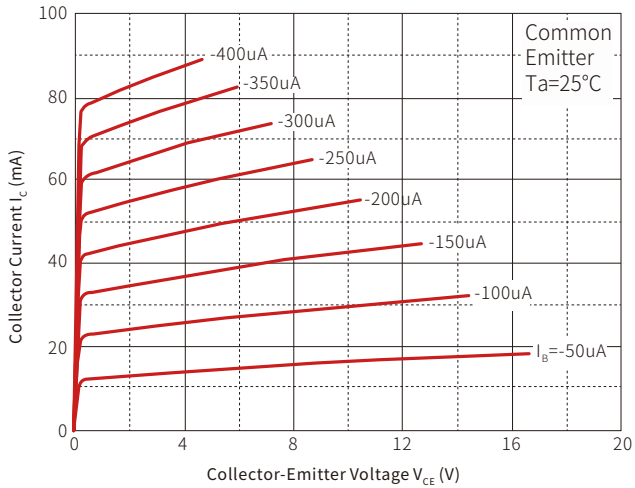

$h_{FE} \text{ — } I_c$

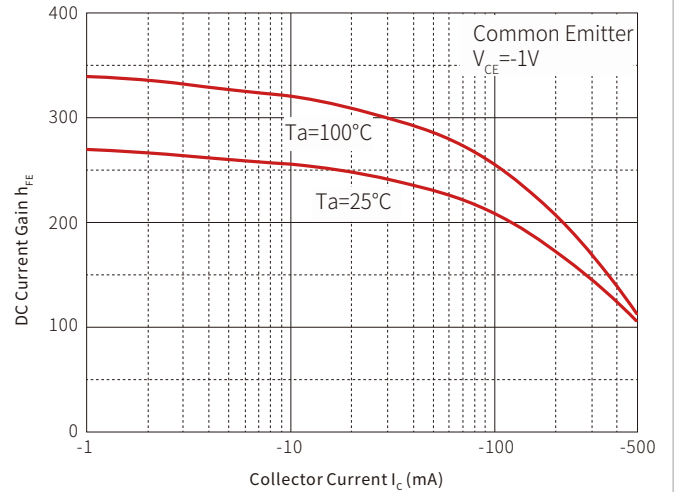

$V_{CEsat} \text{ — } I_c$

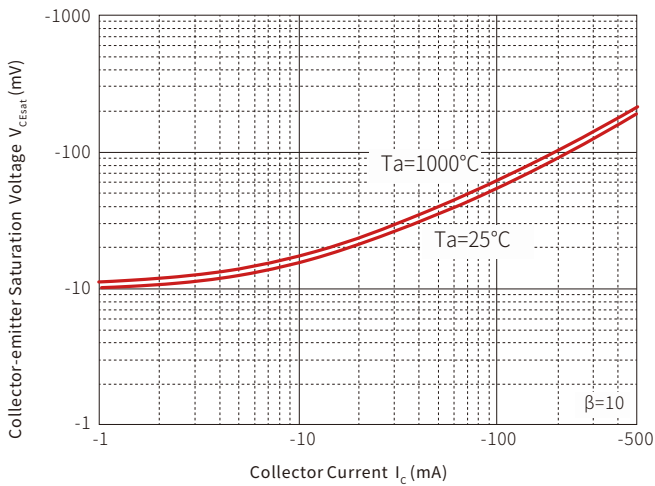

$V_{BEsat} \text{ — } I_c$

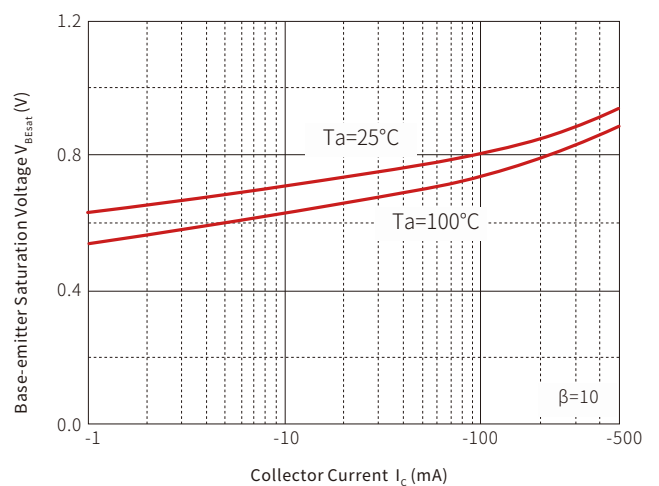

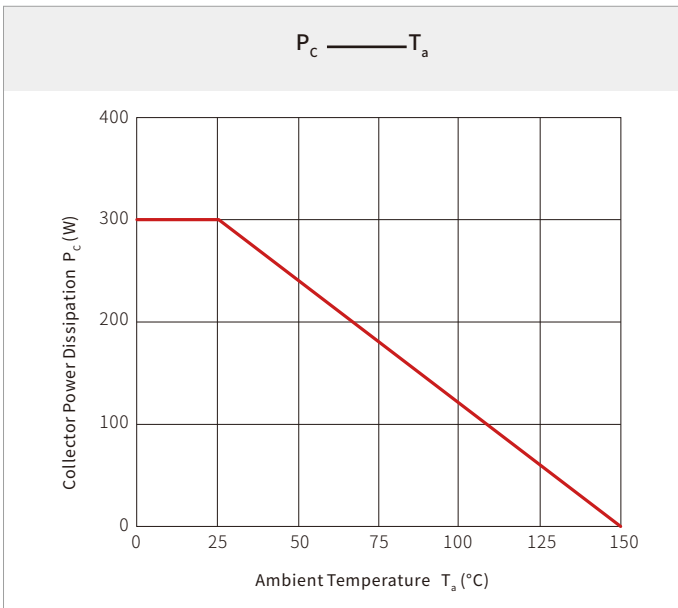
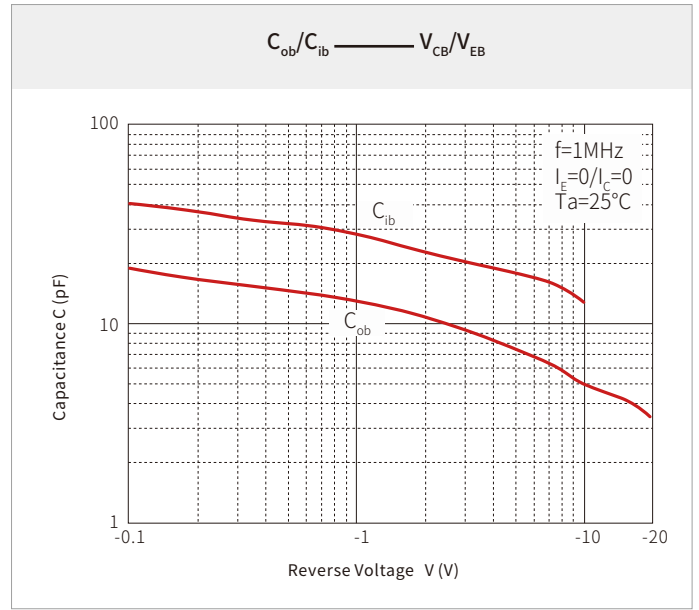
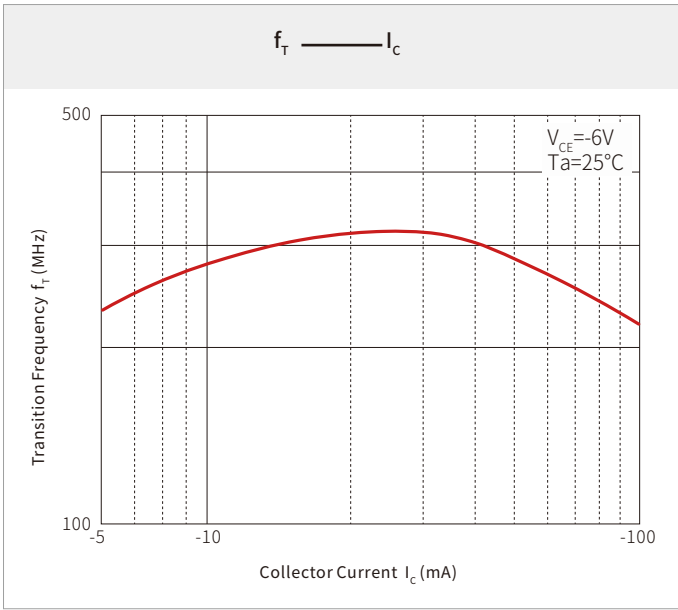

SOLDERING PARAMETERS

Reflow Condition		Lead-free assembly
Pre Heat	Temperature Max ($T_{s(min)}$)	150°C
	Temperature Max ($T_{s(max)}$)	200°C
	Time (min to max) (t_s)	60 – 180 secs
Average ramp up rate (Liquidus Temp (T_L) to peak)		3°C/second max
$T_{s(max)}$ to T_L - Ramp-up Rate		3°C/second max
Reflow	Temperature (T_i) (Liquidus)	217°C
	Time (min to max) (t_i)	60 – 150 seconds
Peak Temperature (T_p)		260°C
Time within 5°C of actual peak Temperature (t_p)		20 – 40 seconds
Ramp-down Rate		6°C/second max
Time 25°C to peak Temperature (T_p)		8 minutes max.
Do not exceed		260°C

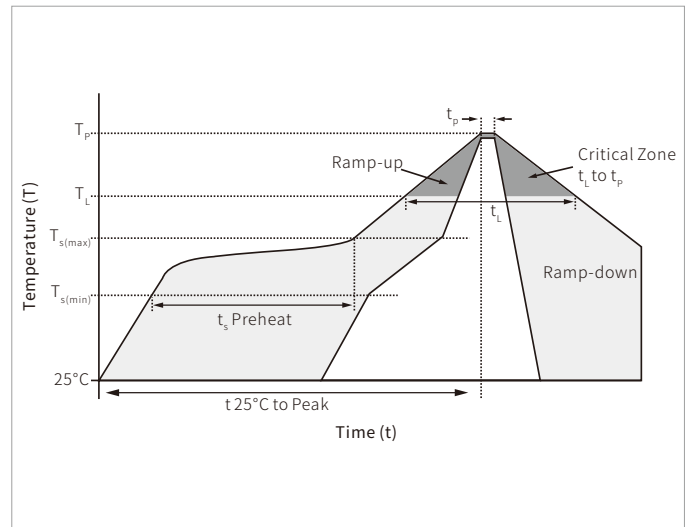

SOT-23 PACKAGE INFORMATION

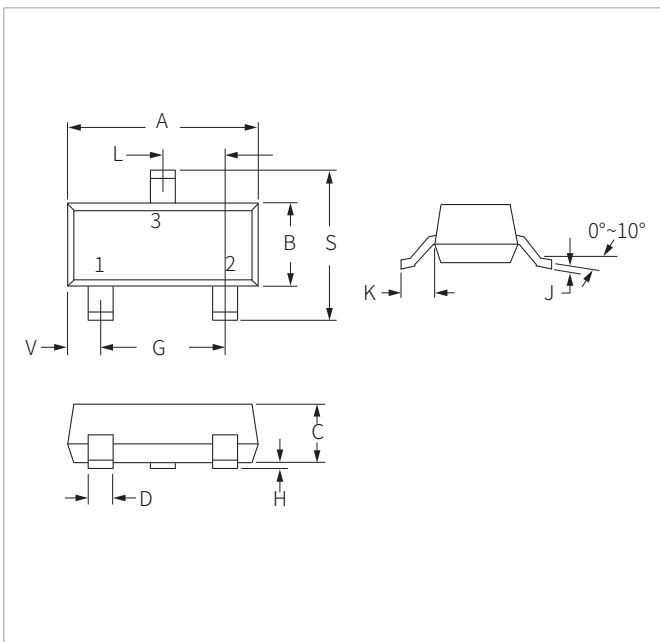

Ref.	Millimeters		Inches	
	Min.	Max.	Min.	Max.
A	2.80	3.05	0.110	0.120
B	1.20	1.40	0.047	0.055
C	0.90	1.15	0.035	0.045
D	0.37	0.50	0.015	0.020
G	1.75	2.05	0.069	0.081
H	0.01	0.100	0.001	0.004
J	0.085	0.180	0.003	0.007
K	0.35	0.69	0.014	0.029
L	0.89	1.02	0.035	0.040
S	2.10	2.65	0.083	0.104
V	0.45	0.60	0.018	0.024

RECOMMENDED PAD LAYOUT DIMENSIONS

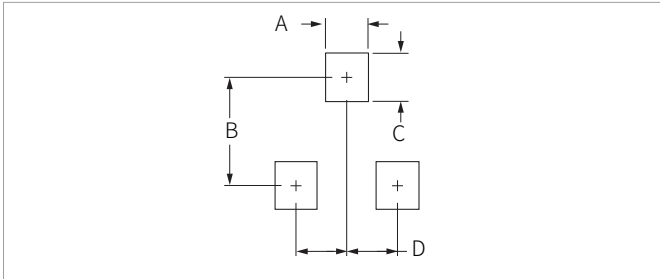

Ref.	Millimeters		Inches	
	Min.	Max.	Min.	Max.
A	0.71	0.97	0.028	0.038
B	1.88	2.13	0.074	0.084
C	0.71	0.97	0.028	0.038
D	0.81	1.07	0.032	0.042

ORDERING INFORMATION

Part Number	Component Package	QTY/Reel	Reel Size
S9012	SOT-23	3000PCS	7"

Headquarters

No.3387 Shendu Road
Pujiang I&E Park
Minhang Shanghai China
201000

Hotline

400-021-5756

Web

<https://www.semiware.com>

Sales Center

Tel: 86-21-3463-7458
Email: sales18@semiware.com

Customer Service

Tel: 86-21-5484-1001
Email: sales17@semiware.com

Technical Support

Tel: 86-21-3463-7654
Email: fae01@semiware.com

Complaint & Suggestions

Tel: 86-21-3463-7172
Ext: 8868
Email: cs03@semiware.com

By QR Code

Website



Wechat

To find your local partner within Semiware' s global website: www.semiware.com

© 2022 Semiware Semiconductor Inc.

The content of this document has been carefully checked and understood. However, neither Semiware nor its subsidiaries assume any liability whatsoever for any errors or inaccuracies of this document and the consequences thereof. Published specifications are subject to change without notice. Product suitability for any area of application must ultimately be determined by the customer. In all cases, products must never be operated outside their published specifications. Semiware does not guarantee the availability of all published products. This disclaimer shall be governed by substantive Chinese law and resulting disputes shall be settled by the courts at the place of business of Semiware. Latest publications and a complete disclaimer can be downloaded from the Semiware website. All trademarks recognized.