

## FEATURES

- | Glass-passivated mesa chip for reliability and uniform
- | High current output up to 12 A
- | RoHS (2002/95/EC) compliant packages

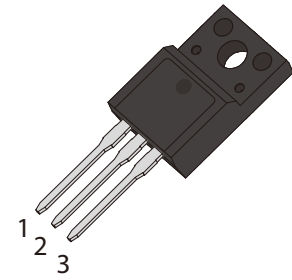

TO-220F

## APPLICATIONS

- | Flash lamp
- | Electronic ballast
- | Igniter

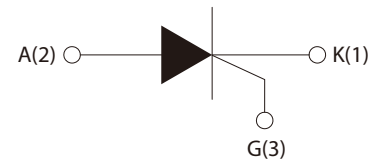

Schematic Symbol

## APPROVALS

|             |                                    |
|-------------|------------------------------------|
| <b>RoHS</b> | Compliance with 2011/65/EU         |
| <b>HF</b>   | Compliance with IEC61249-2-21:2003 |

## ABSOLUTE MAXIMUM RATINGS

| Parameter                                                        | Symbol              | Value    | Unit                   |
|------------------------------------------------------------------|---------------------|----------|------------------------|
| Repetitive peak off-state voltage ( $T_j=25^\circ\text{C}$ )     | $V_{\text{DRM}}$    | 600      | V                      |
| Repetitive peak reverse voltage ( $T_j=25^\circ\text{C}$ )       | $V_{\text{RRM}}$    | 600      |                        |
| RMS on-state current ( $T_c=85^\circ\text{C}$ )                  | $I_{\text{T(RMS)}}$ | 12       | A                      |
| Non repetitive surge peak on-state current ( $t_p=10\text{ms}$ ) | $I_{\text{TSM}}$    | 100      |                        |
| $I^2t$ value for fusing ( $t_p=10\text{ms}$ )                    | $I^2t$              | 50       | $\text{A}^2\text{S}$   |
| Critical rate of rise of on-state current ( $I_G=2*I_{GT}$ )     | $d/d_t$             | 50       | $\text{A}/\mu\text{s}$ |
| Peak gate current                                                | $I_{\text{GM}}$     | 1.2      | A                      |
| Average gate power dissipation                                   | $P_{\text{G(AV)}}$  | 0.2      | W                      |
| Storage junction temperature range                               | $T_{\text{STG}}$    | -40~+150 | $^\circ\text{C}$       |
| Operating junction temperature range                             | $T_j$               | -40~+125 |                        |

## ELECTRICAL CHARACTERISTICS ( $T_j=25^{\circ}\text{C}$ unless otherwise specified)

| Symbol    | Test Condition                                               | Value |      |      | Unit                   |
|-----------|--------------------------------------------------------------|-------|------|------|------------------------|
|           |                                                              | Min.  | Typ. | Max. |                        |
| $I_{GT}$  | $V_D=12\text{V}, R_L=33\Omega$                               | -     | 60   | 200  | $\mu\text{A}$          |
| $V_{GT}$  |                                                              | -     | -    | 0.8  | V                      |
| $V_{GD}$  | $V_D=V_{DRM}, T_j=110^{\circ}\text{C}$                       | 0.2   | -    | -    |                        |
| $I_H$     | $I_T=50\text{mA}$                                            | -     | -    | 5    |                        |
| $I_L$     | $I_G=1.2I_{GT}$                                              | -     | -    | 6    |                        |
| $dV_D/dt$ | $V_D=536\text{V}, R_{GK}=100\Omega, T_j=110^{\circ}\text{C}$ | 50    | 100  | -    | $\text{V}/\mu\text{s}$ |

## STATIC CHARACTERISTICS

| Symbol    | Parameter                               | Value      | Unit          |
|-----------|-----------------------------------------|------------|---------------|
| $V_{TM}$  | $I_{TM}=24\text{A}, t_p=380\mu\text{s}$ | $\leq 1.6$ | V             |
| $I_{DRM}$ | $V_D=V_{DRM}, V_R=V_{RRM}$              | $\leq 10$  | $\mu\text{A}$ |
| $I_{RRM}$ |                                         | $\leq 2$   | mA            |

## THERMAL RESISTANCES

| Symbol        | Parameter            | Value | Unit                        |
|---------------|----------------------|-------|-----------------------------|
| $R_{th(j-c)}$ | Junction to case(AC) | 2.3   | $^{\circ}\text{C}/\text{W}$ |

# PARAMETER CHARACTERISTIC CURVE

**FIG.1 Maximum power dissipation versus RMS on-state current**

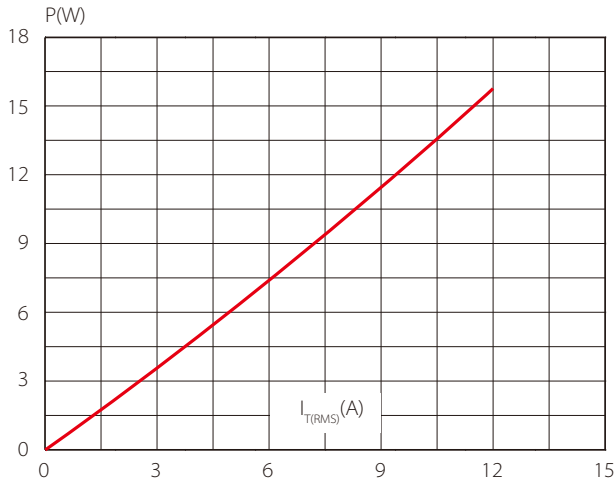

**FIG.2: RMS on-state current versus case temperature**

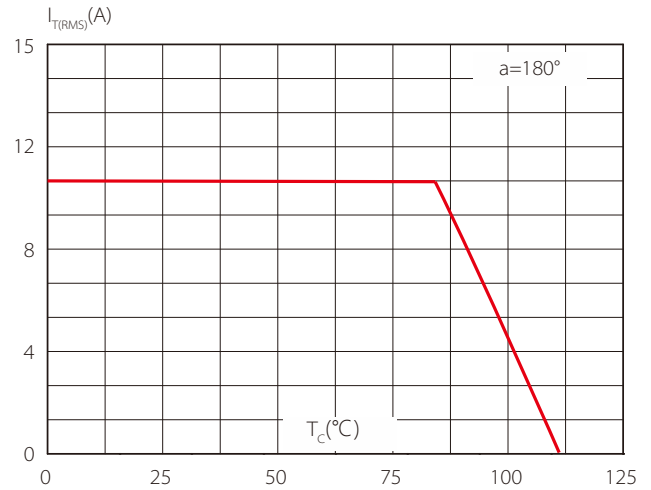

**FIG.3: Surge peak on-state current versus number of cycles**

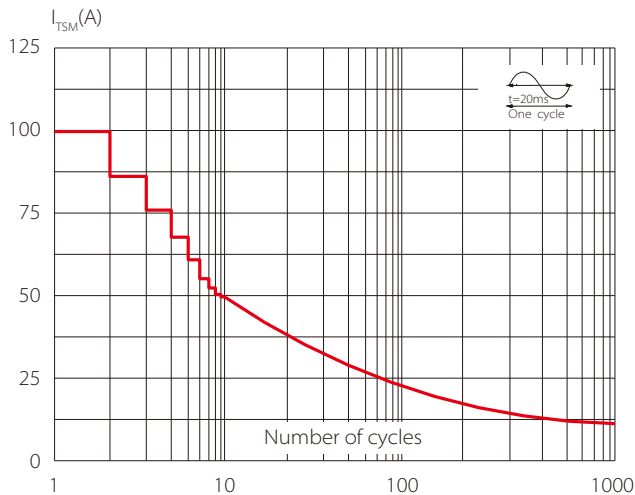

**FIG.4 On-state characteristics (maximum values)**

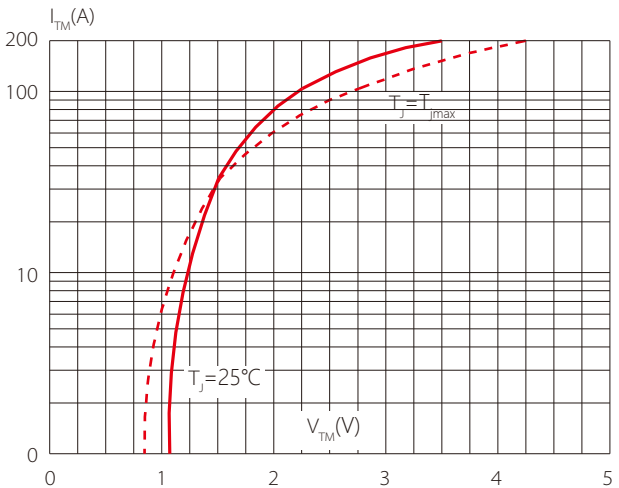

**FIG.5: Non-repetitive surge peak on-state current for a sinusoidal pulse with width  $t_p < 10\text{ms}$  and corresponding value of  $I^2t$  ( $dI/dt < 50\text{A}/\mu\text{s}$ )**

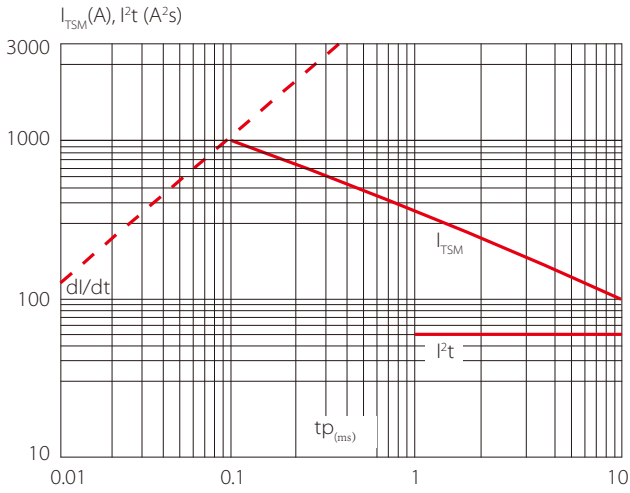

**FIG.6 Relative variations of gate trigger current versus junction temperature**

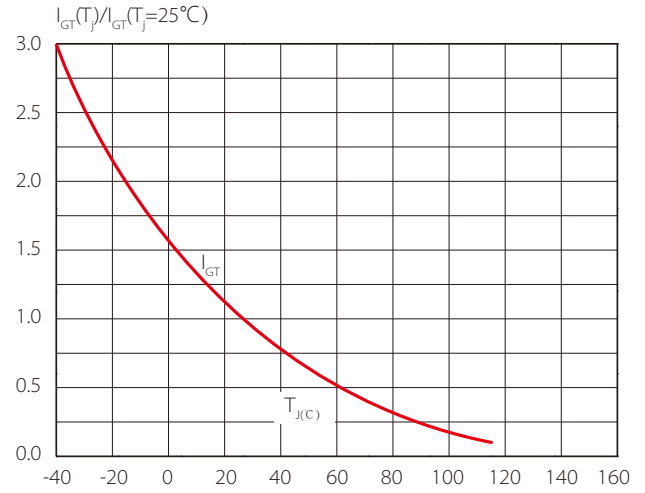

**FIG.7 Relative variations of holding current versus junction temperature**

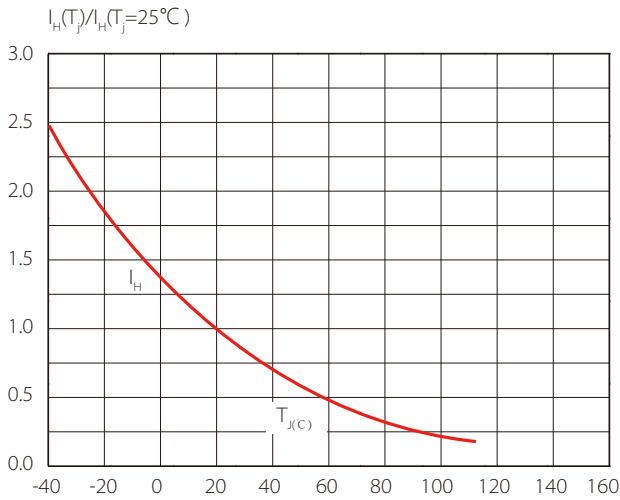

**FIG.8 Relative variations of latching current versus junction temperature**

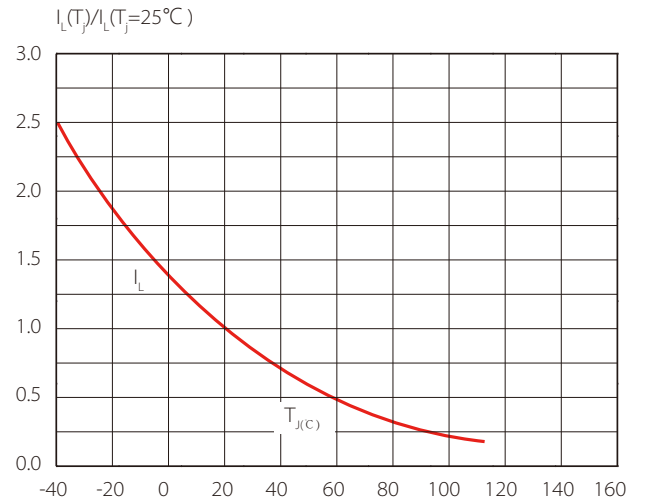

## PACKAGE MECHANICAL DATA

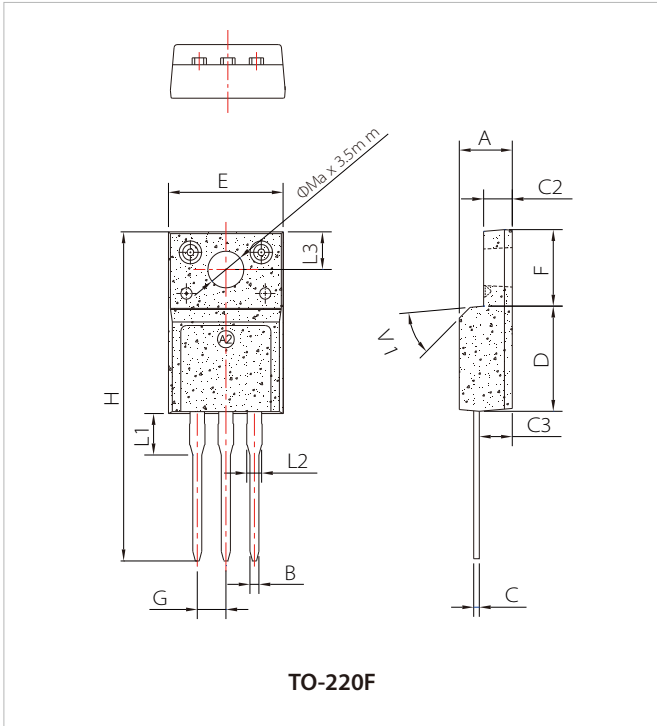

| Ref. | Dimensions  |      |      |        |       |       |
|------|-------------|------|------|--------|-------|-------|
|      | Millimeters |      |      | Inches |       |       |
|      | Min.        | Typ. | Max. | Min.   | Typ.  | Max.  |
| A    | 4.50        |      | 4.90 | 0.177  |       | 0.193 |
| B    | 0.74        | 0.80 | 0.83 | 0.029  | 0.029 | 0.033 |
| C    | 0.47        |      | 0.65 | 0.019  |       | 0.026 |
| C2   | 2.45        |      | 2.75 | 0.096  |       | 0.108 |
| C3   | 2.60        |      | 3.00 | 0.102  |       | 0.118 |
| D    | 8.80        |      | 9.30 | 0.346  |       | 0.366 |
| E    | 9.80        |      | 10.4 | 0.386  |       | 0.410 |
| F    | 6.40        |      | 6.80 | 0.252  |       | 0.268 |
| G    |             | 2.54 |      |        | 0.1   |       |
| H    | 28.0        |      | 29.8 | 1.102  |       | 1.173 |
| L1   |             | 3.63 |      |        | 0.143 |       |
| L2   | 1.14        |      | 1.70 | 0.045  |       | 0.067 |
| L3   |             | 3.30 |      |        | 0.130 |       |
| V1   |             | 45°  |      |        | 45°   |       |

## ORDERING INFORMATION

| Part Number | Package | Qty/pcs |           |        |
|-------------|---------|---------|-----------|--------|
|             |         | Tube    | Inner Box | Carton |
| SCF12M60    | TO-220F | 50      | 1000      | 5000   |

**Headquarters**

No.3387 Shendu Road Pujiang  
I&E Park  
Minhang Shanghai China  
201000

**Hotline**

400-021-5756

**Web**

<https://www.semiware.com>

**Sales center**

Tel: 86-21-3463-7458  
Email: [sales18@semiware.com](mailto:sales18@semiware.com)

**Customer Service**

Tel: 86-21-5484-1001  
Email: [sales17@semiware.com](mailto:sales17@semiware.com)

**Technical Support**

Tel: 86-21-3463-7654  
Email: [fae01@semiware.com](mailto:fae01@semiware.com)

**Complaint & Suggestions**

Tel: 86-21-3463-7172  
Ext: 8868  
Email: [cs03@semiware.com](mailto:cs03@semiware.com)

**By QR Code**

Website



Wechat

To find your local partner within Semiware's global network: [www.semiware.com](http://www.semiware.com)

© 2022 Semiware Semiconductor Inc.

The content of this document has been carefully checked and understood. However, neither Semiware nor its subsidiaries assume any liability whatsoever for any errors or inaccuracies of this document and the consequences thereof. Published specifications are subject to change without notice. Product suitability for any area of application must ultimately be determined by the customer. In all cases, products must never be operated outside their published specifications. Semiware does not guarantee the availability of all published products. This disclaimer shall be governed by substantive Swiss law and resulting disputes shall be settled by the courts at the place of business of Semiware. Latest publications and a complete disclaimer can be downloaded from the Semiware website. All trademarks recognized.