

## FEATURES

- | 350W Peak Pulse Power per Line (tp=8/20μs)
- | Protects two Bidirectional lines
- | Low clamping voltage
- | Working voltages : 12 V
- | Low Leakage current

## APPLICATIONS

- | Cellular Phone Handsets and Accessories
- | Microprocessor based equipment
- | Personal Digital Assistants (PDA's)
- | Notebooks,Desktops,and Servers
- | Portable Inserumentation
- | Networking and Telecom
- | Servers and Parallel Ports
- | Peripherals



SOT-23

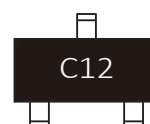

Marking

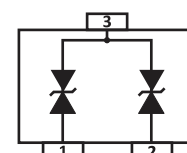

Schematic Symbol

## IEC COMPATIBILITY

- | IEC61000-4-2 (ESD) ±15kV (air), ±8kV (contact)
- | IEC61000-4-4 (EFT) 40A (5/50ns)

## APPROVALS

- |             |                                    |
|-------------|------------------------------------|
| <b>RoHS</b> | Compliance with 2011/65/EU         |
| <b>HF</b>   | Compliance with IEC61249-2-21:2003 |

## THERMAL CONSIDERATIONS

Symbol	Parameter	Value	Unit
$P_{PP}$	Peak Pulse Power (tp=8/20μs waveform)	350	Watts
$T_J$	Operating Temperature Range	-55 to +150	°C
$T_{STG}$	Storage Temperature Range	-55 to +150	°C

## ELECTRICAL CHARACTERISTICS

Symbol	Parameter	Condition	Min.	Typ.	Max.	Unit
$V_{RWM}$	Reverse Stand-off Voltage				12	V
$V_{BR}$	Reverse Breakdown Voltage	$I_T=1\text{mA}$	13.3			V
$I_R$	Reverse Leakage Current	$V_{RWM}=12\text{V}$			1	μA
$V_C$	Clamping Voltage (Tp=8/20us)	$I_{pp}=1\text{A}, tp=8/20\text{us}$			19	V
$V_C$	Clamping Voltage (Tp=8/20us)	$I_{pp}=11\text{A}, tp=8/20\text{us}$			32	V
$I_{pp}$	Peak Pulse Current (Tp=8/20us)	tp=8/20us			11	A
$C_J$	Off State Junction Capacitance	$V_R=0\text{V}, f=1\text{MHz}$			75	pF

## CHARACTERISTIC CURVES

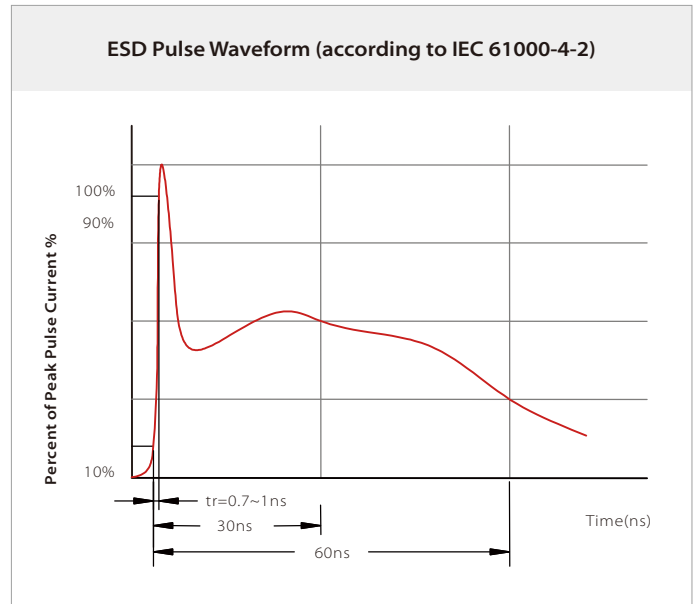
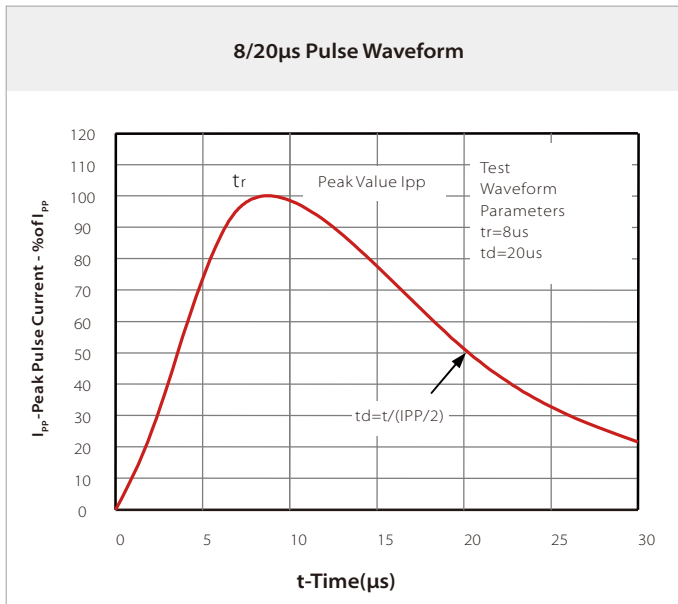

## SOLDERING PARAMETERS

Reflow Condition		Lead-free assembly
Pre Heat	Temperature Max ( $T_{s(min)}$ )	150°C
	Temperature Max ( $T_{s(max)}$ )	200°C
	Time (min to max) ( $t_s$ )	60 – 180 secs
Average ramp up rate (Liquidus Temp ( $T_L$ ) to peak)		3°C/second max
$T_{s(max)}$ to $T_L$ - Ramp-up Rate		3°C/second max
Reflow	Temperature ( $T_L$ ) (Liquidus)	217°C
	Time (min to max) ( $t_L$ )	60 – 150 seconds
Peak Temperature ( $T_p$ )		260°C
Time within 5°C of actual peak Temperature ( $t_p$ )		20 – 40 seconds
Ramp-down Rate		6°C/second max
Time 25°C to peak Temperature ( $T_p$ )		8 minutes max.
Do not exceed		260°C

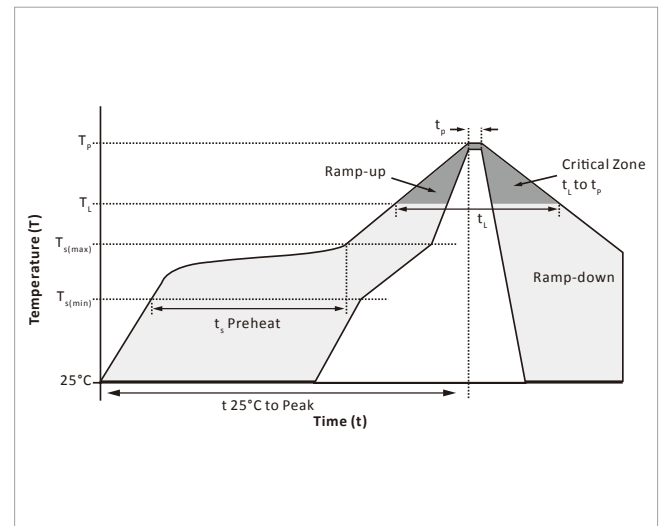

## SOT-23 PACKAGE INFORMATION

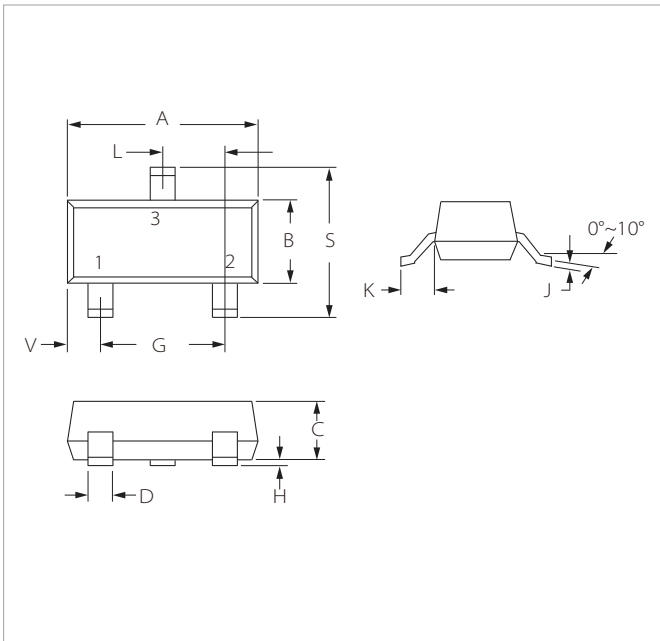

Ref.	Millimeters		Inches	
	Min.	Max.	Min.	Max.
A	2.80	3.04	0.110	0.120
B	1.20	1.40	0.047	0.055
C	0.89	1.11	0.035	0.044
D	0.37	0.50	0.015	0.020
G	1.78	2.04	0.070	0.081
H	0.01	0.100	0.001	0.004
J	0.085	0.180	0.003	0.007
K	0.35	0.69	0.014	0.029
L	0.89	1.02	0.035	0.040
S	2.10	2.64	0.083	0.104
V	0.45	0.60	0.018	0.024

## RECOMMENDED PAD LAYOUT DIMENSIONS

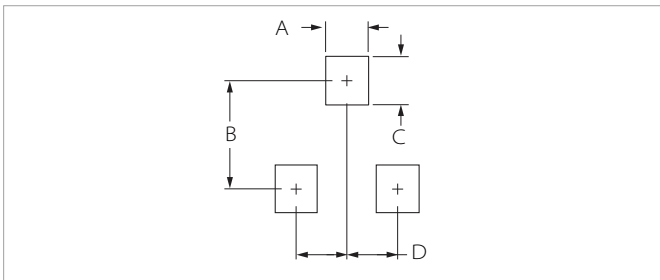

Ref.	Millimeters		Inches	
	Min.	Max.	Min.	Max.
A	0.71	0.97	0.028	0.038
B	1.88	2.13	0.074	0.084
C	0.71	0.97	0.028	0.038
D	0.81	1.07	0.032	0.042

## ORDERING INFORMATION

Part Number	Component Package	QTY/Reel	Reel Size
SE23T35B12B	SOT-23	3000PCS	7"

**Headquarters**

No.3387 Shendu Road Pujiang  
I&E Park  
Minhang Shanghai China  
201000

**Hotline**

400-021-5756

**Web**

<https://www.semiware.com>

**Sales Center**

Tel: 86-21-3463-7458  
Email: [sales18@semiware.com](mailto:sales18@semiware.com)

**Customer Service**

Tel: 86-21-5484-1001  
Email: [sales17@semiware.com](mailto:sales17@semiware.com)

**Technical Support**

Tel: 86-21-3463-7654  
Email: [fae01@semiware.com](mailto:fae01@semiware.com)

**Complaint & Suggestions**

Tel: 86-21-3463-7172  
Ext: 8868  
Email: [cs03@semiware.com](mailto:cs03@semiware.com)

**By QR Code**

Website



Wechat

To find your local partner within Semiware's global network: [www.semiware.com](http://www.semiware.com)

© 2022 Semiware Semiconductor Inc.

The content of this document has been carefully checked and understood. However, neither Semiware nor its subsidiaries assume any liability whatsoever for any errors or inaccuracies of this document and the consequences thereof. Published specifications are subject to change without notice. Product suitability for any area of application must ultimately be determined by the customer. In all cases, products must never be operated outside their published specifications. Semiware does not guarantee the availability of all published products. This disclaimer shall be governed by substantive Chinese law and resulting disputes shall be settled by the courts at the place of business of Semiware. Latest publications and a complete disclaimer can be downloaded from the Semiware website. All trademarks recognized.