

FEATURES

- | 350W Peak Pulse Power per Line (tp=8/20μs)
- | Protects one bidirectional line or two unidirectional lines
- | Low clamping voltage

APPLICATIONS

- | Cellular Handsets and Accessories
- | Portable Electronics
- | Industrial Controls
- | Set-Top Box
- | Instrumentation
- | Servers, Notebook, and Desktop PC



SOT-23

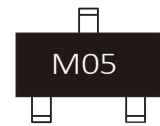

Marking

IEC COMPATIBILITY

- | IEC61000-4-2 (ESD) ±15kV (air), ±8kV (contact)
- | IEC61000-4-4 (EFT) 40A (5/50ns)

APPROVALS

- | | |
|-------------|------------------------------------|
| RoHS | Compliance with 2011/65/EU |
| HF | Compliance with IEC61249-2-21:2003 |

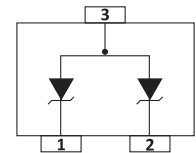

Schematic Symbol

THERMAL CONSIDERATIONS

Symbol	Parameter	Value	Unit
P_{PP}	Peak Pulse Power (tp=8/20μs waveform)	350	Watts
T_J	Operating Temperature Range	-55 to +150	°C
T_{STG}	Storage Temperature Range	-55 to +150	°C

ELECTRICAL CHARACTERISTICS

Symbol	Parameter	Condition	Min.	Typ.	Max.	Unit
V_{RWM}	Reverse Stand-off Voltage				5	V
V_{BR}	Reverse Breakdown Voltage	$I_T=1\text{mA}$	6			V
I_R	Reverse Leakage Current	$V_{RWM}=5\text{V}$			10	μA
V_C	Clamping Voltage (Tp=8/20us)	$I_{pp}=1\text{A}, tp=8/20\text{us}$			9.8	V
V_C	Clamping Voltage (Tp=8/20us)	$I_{pp}=24\text{A}, tp=8/20\text{us}$			16	V
I_{PP}	Peak Pulse Current (Tp=8/20us)	tp=8/20us			24	A
C_J	Off State Junction Capacitance	$V_R=0\text{V}, f=1\text{MHz}$			300	pF

CHARACTERISTIC CURVES

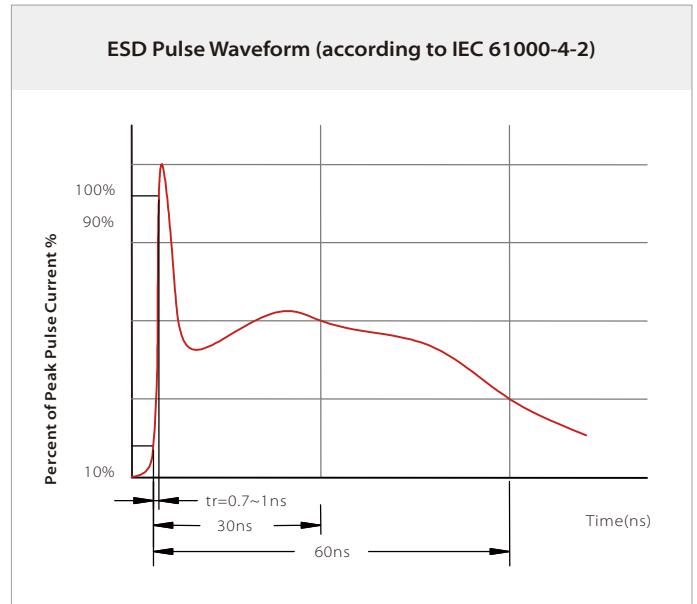
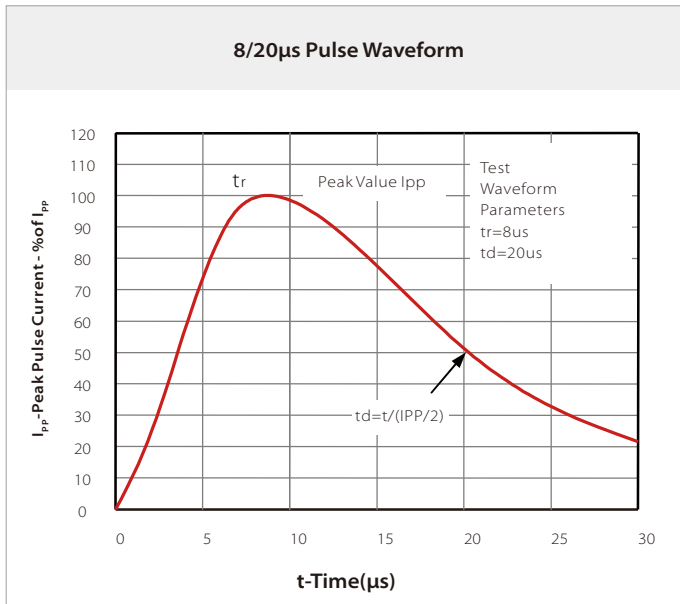

SOLDERING PARAMETERS

Reflow Condition		Lead-free assembly
Pre Heat	Temperature Max ($T_{s(min)}$)	150°C
	Temperature Max ($T_{s(max)}$)	200°C
	Time (min to max) (t_p)	60 – 180 secs
Average ramp up rate (Liquidus Temp (T_L) to peak)		3°C/second max
$T_{s(max)}$ to T_L - Ramp-up Rate		3°C/second max
Reflow	Temperature (T_L) (Liquidus)	217°C
	Time (min to max) (t_L)	60 – 150 seconds
Peak Temperature (T_p)		260°C
Time within 5°C of actual peak Temperature (t_p)		20 – 40 seconds
Ramp-down Rate		6°C/second max
Time 25°C to peak Temperature (T_p)		8 minutes max.
Do not exceed		260°C

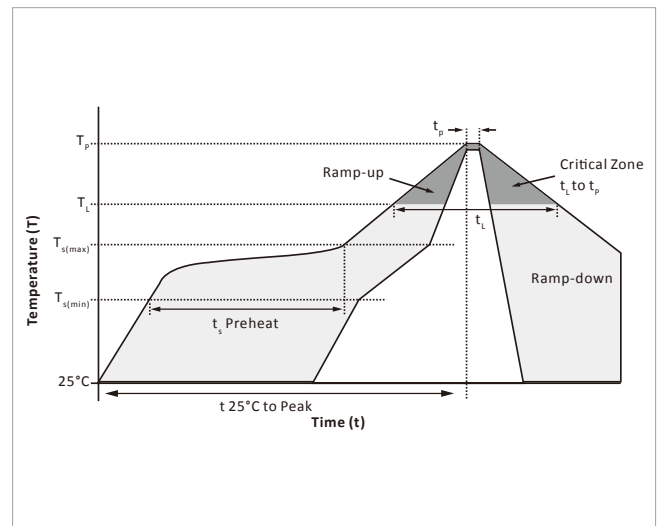

SOT-23 PACKAGE INFORMATION

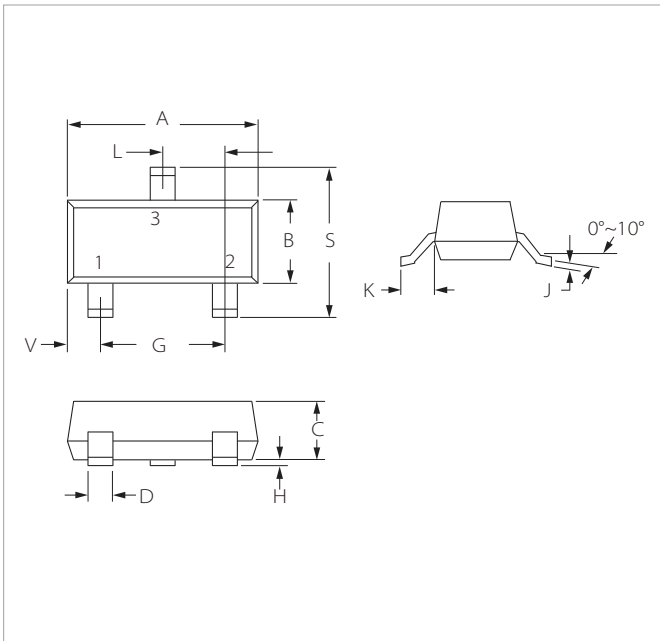

Ref.	Millimeters		Inches	
	Min.	Max.	Min.	Max.
A	2.80	3.04	0.110	0.120
B	1.20	1.40	0.047	0.055
C	0.89	1.11	0.035	0.044
D	0.37	0.50	0.015	0.020
G	1.78	2.04	0.070	0.081
H	0.01	0.10	0.001	0.004
J	0.08	0.18	0.003	0.007
K	0.35	0.69	0.014	0.029
L	0.89	1.02	0.035	0.040
S	2.10	2.64	0.083	0.104
V	0.45	0.60	0.018	0.024

RECOMMENDED PAD LAYOUT DIMENSIONS

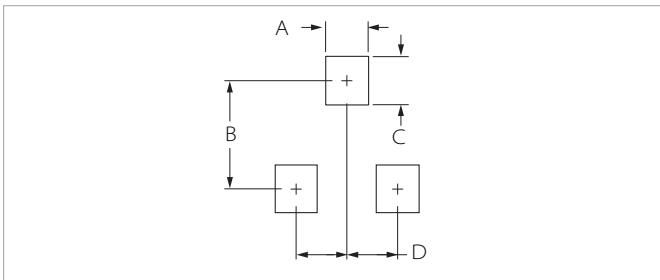

Ref.	Millimeters		Inches	
	Min.	Max.	Min.	Max.
A	0.71	0.97	0.028	0.038
B	1.88	2.13	0.074	0.084
C	0.71	0.97	0.028	0.038
D	0.81	1.07	0.032	0.042

ORDERING INFORMATION

Part Number	Component Package	QTY/Reel	Reel Size
SE23T35U5.0B	SOT-23	3000PCS	7"

Headquarters

No.3387 Shendu Road Pujiang
I&E Park
Minhang Shanghai China
201000

Hotline

400-021-5756

Web

<https://www.semiware.com>

Sales Center

Tel: 86-21-3463-7458
Email: sales18@semiware.com

Customer Service

Tel: 86-21-5484-1001
Email: sales17@semiware.com

Technical Support

Tel: 86-21-3463-7654
Email: fae01@semiware.com

Complaint & Suggestions

Tel: 86-21-3463-7172
Ext: 8868
Email: cs03@semiware.com

By QR Code

Website



Wechat

To find your local partner within Semiware's global network: www.semiware.com

© 2022 Semiware Semiconductor Inc.

The content of this document has been carefully checked and understood. However, neither Semiware nor its subsidiaries assume any liability whatsoever for any errors or inaccuracies of this document and the consequences thereof. Published specifications are subject to change without notice. Product suitability for any area of application must ultimately be determined by the customer. In all cases, products must never be operated outside their published specifications. Semiware does not guarantee the availability of all published products. This disclaimer shall be governed by substantive Chinese law and resulting disputes shall be settled by the courts at the place of business of Semiware. Latest publications and a complete disclaimer can be downloaded from the Semiware website. All trademarks recognized.