

## FEATURES

- | Construction Utilizes Void-free Molded Plastic Technique

---

- | Low Reverse Leakage

---

- | High Forward Surge Current Capability

---

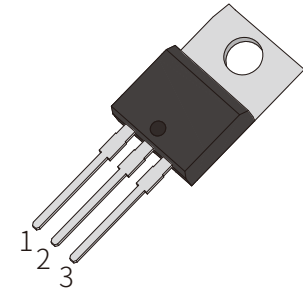
TO-220AB

## MECHANICAL DATA

- | Case : Molded Plastic Body

---

- | Terminals : Solder plated, solderable per MIL-STD-750,Method 2026

---

- | Mounting Position : Any

---

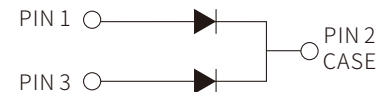
Schematic Symbol

## APPROVALS

|             |                                    |
|-------------|------------------------------------|
| <b>RoHS</b> | Compliance with 2011/65/EU         |
| <b>HF</b>   | Compliance with IEC61249-2-21:2003 |

## MAXIMUM RATINGS (T<sub>A</sub>=25°C )

| Parameter  | Symbol                | SF 2005FCT<br>SF 2005FCT | SF 2010FCT<br>SF 2010FCT | SF 2020FCT<br>SF 2020FCT | SF 2040FCT<br>SF 2040FCT | SF 2050FCT<br>SF 2050FCT | SF 2060FCT<br>SF 2060FCT | Unit |
|--|-----------------------|--------------------------|--------------------------|--------------------------|--------------------------|--------------------------|--------------------------|------|
| Marking  |                       | SF 2005FCT               | SF 2010FCT               | SF 2020FCT               | SF 2040FCT               | SF 2050FCT               | SF 2060FCT               |      |
| Maximum Repetitive Peak Reverse Voltage  | V <sub>RRM</sub>      | 50                       | 100                      | 200                      | 400                      | 500                      | 600                      | V    |
| Maximum RMS Voltage  | V <sub>RMS</sub>      | 35                       | 70                       | 140                      | 280                      | 350                      | 420                      | V    |
| Maximum DC Blocking Voltage  | V <sub>DC</sub>       | 50                       | 100                      | 200                      | 400                      | 500                      | 600                      | V    |
| Maximum Average Forward Rectified Current at T <sub>c</sub> =110°C                 | per device            | 20.0                     |                          |                          |                          |                          |                          | A    |
|  | per diode             | 10.0                     |                          |                          |                          |                          |                          |      |
| Peak Forward Surge Current, 8.3ms Single Half Sine-wave Superimposed On Rated Load | I <sub>FSM</sub>      | 200.0                    |                          |                          |                          |                          |                          | A    |
| Maximum Instantaneous Forward Voltage per Diode at 10.0A                           | V <sub>F</sub>        | 1.0                      |                          | 1.3                      |                          | 2.0                      |                          | V    |
| Maximum DC Reverse Current at Rated DC Blocking Voltage                            | T <sub>A</sub> =25°C  | 10                       |                          |                          |                          |                          |                          | μA   |
|  | T <sub>A</sub> =125°C | 500                      |                          |                          |                          |                          |                          | μA   |
| Maximum Reverse Recovery Time <sup>(Note 1)</sup>                                  | T <sub>rr</sub>       | 35                       |                          |                          |                          |                          |                          | ns   |
| Typical Thermal Resistance   | R <sub>θJC</sub>      | 3.5                      |                          |                          |                          |                          |                          | °C/W |
| Operating Junction Temperature Range   | T <sub>J</sub>        | -55 to +150              |                          |                          |                          |                          |                          | °C   |
| Storage Temperature Range  | T <sub>STG</sub>      | -55 to +150              |                          |                          |                          |                          |                          | °C   |

 Note:1.Reverse recovery time test condition: I<sub>F</sub>=0.5A I<sub>R</sub>=1.0A I<sub>rr</sub>=0.25A

# CHARACTERISTIC CURVES

Fig. 1- Derating Curve Output Rectified Current

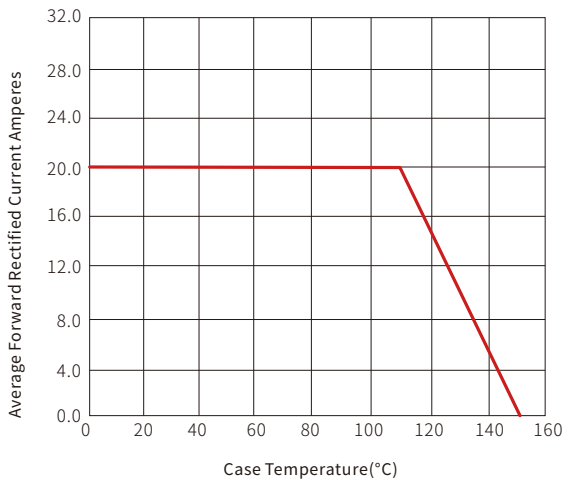

Fig. 2-Maximum Non-Repetitive Peak Forward Surge Current Perleg

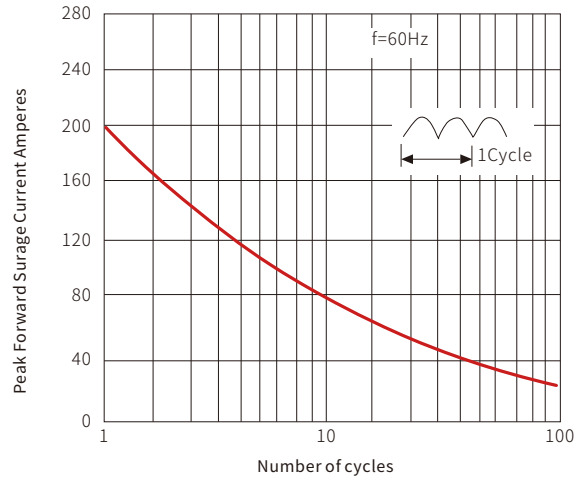

Fig. 3-Typical Forward Voltage Characteristics

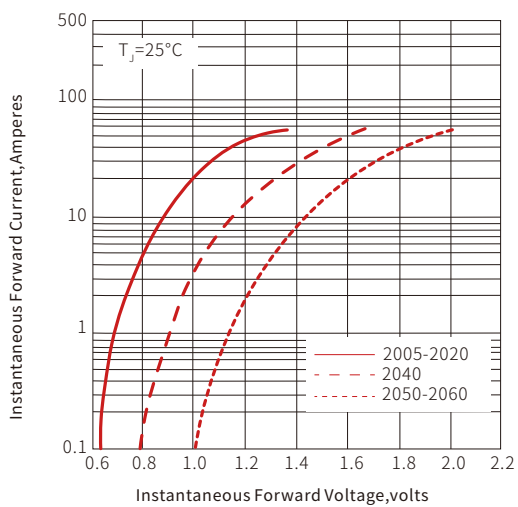
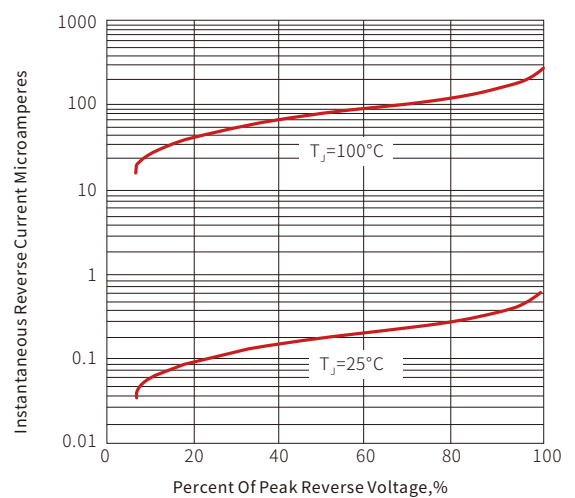
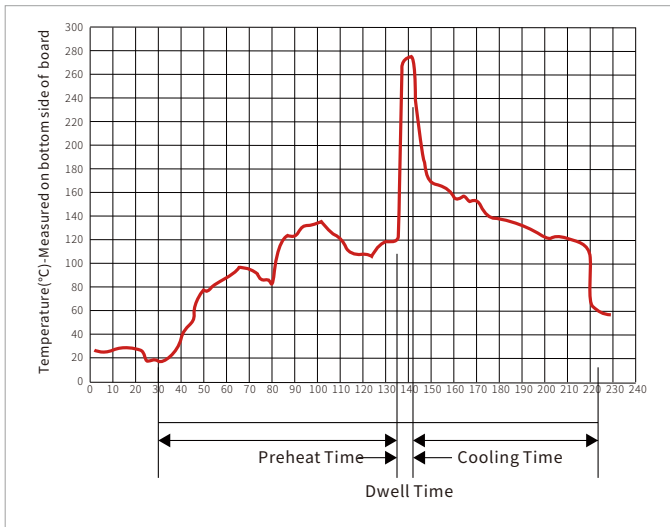

Fig. 4-Typical Reverse Leakage Characteristics



## WAVE SOLDERING



| Wave Parameter         |                  | Lead-free assembly |
|------------------------|------------------|--------------------|
| Pre Heat               | Temperature Min  | 100°C              |
|                        | Temperature Max  | 150°C              |
|                        | Time(min to max) | 60 – 180 secs      |
| Solder pot Temperature |                  | 280°C Max          |
| Solder Dwell Time      |                  | 2-5 seconds        |

## TO-220AB PACKAGE MECHANICAL DATA

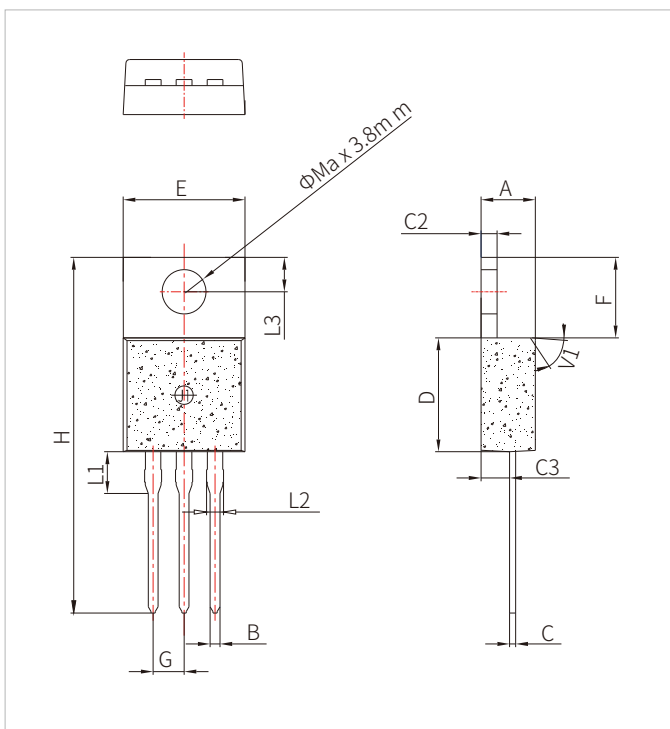

| Ref. | Dimensions  |      |      |        |       |       |
|------|-------------|------|------|--------|-------|-------|
|      | Millimeters |      |      | Inches |       |       |
|      | Min.        | Typ. | Max. | Min.   | Typ.  | Max.  |
| A    | 4.40        |      | 4.60 | 0.173  |       | 0.181 |
| B    | 0.61        |      | 0.88 | 0.024  |       | 0.035 |
| C    | 0.46        |      | 0.70 | 0.018  |       | 0.028 |
| C2   | 1.21        |      | 1.32 | 0.048  |       | 0.052 |
| C3   | 2.40        |      | 2.72 | 0.094  |       | 0.107 |
| D    | 8.60        |      | 9.70 | 0.339  |       | 0.382 |
| E    | 9.80        |      | 10.4 | 0.386  |       | 0.409 |
| F    | 6.55        |      | 6.95 | 0.258  |       | 0.274 |
| G    |             | 2.54 |      |        | 0.1   |       |
| H    | 28.0        |      | 29.8 | 1.102  |       | 1.173 |
| L1   |             | 3.75 |      |        | 0.148 |       |
| L2   | 1.14        |      | 1.70 | 0.045  |       | 0.067 |
| L3   | 2.65        |      | 2.95 | 0.104  |       | 0.116 |
| V1   |             | 45°  |      |        | 45°   |       |

## ORDERING INFORMATION

| Part Number         | Component Package | QTY/Tube | QTY/Box | QTY/Carton |
|---------------------|-------------------|----------|---------|------------|
| SF2005FCT-SF2060FCT | TO-220AB          | 50PCS    | 1000PCS | 5000PCS    |

**Headquarters**

No.3387 Shendu Road  
Pujiang I&E Park  
Minhang Shanghai China  
201000

**Hotline**

400-021-5756

**Web**

<https://www.semiware.com>

**Sales Center**

Tel: 86-21-3463-7458  
Email: [sales18@semiware.com](mailto:sales18@semiware.com)

**Customer Service**

Tel: 86-21-5484-1001  
Email: [sales17@semiware.com](mailto:sales17@semiware.com)

**Technical Support**

Tel: 86-21-3463-7654  
Email: [fae01@semiware.com](mailto:fae01@semiware.com)

**Complaint & Suggestions**

Tel: 86-21-3463-7172  
Ext: 8868  
Email: [cs03@semiware.com](mailto:cs03@semiware.com)

**By QR Code**

Website



Wechat

To find your local partner within Semiware' s global website: [www.semiware.com](http://www.semiware.com)

© 2022 Semiware Semiconductor Inc.

The content of this document has been carefully checked and understood. However, neither Semiware nor its subsidiaries assume any liability whatsoever for any errors or inaccuracies of this document and the consequences thereof. Published specifications are subject to change without notice. Product suitability for any area of application must ultimately be determined by the customer. In all cases, products must never be operated outside their published specifications. Semiware does not guarantee the availability of all published products. This disclaimer shall be governed by substantive Chinese law and resulting disputes shall be settled by the courts at the place of business of Semiware. Latest publications and a complete disclaimer can be downloaded from the Semiware website. All trademarks recognized.