

FEATURES

- | Construction Utilizes Void-free Molded Plastic Technique
- | Low Reverse Leakage
- | High Forward Surge Current Capability

MECHANICAL DATA

- | Case : Molded Plastic Body
- | Polarity : Polarity Symbol Marking On Body
- | Mounting Position : Any

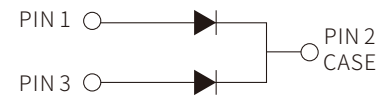
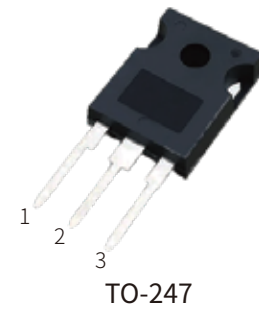

Schematic Symbol

APPROVALS

RoHS	Compliance with 2011/65/EU
HF	Compliance with IEC61249-2-21:2003

MAXIMUM RATINGS AND CHARACTERISTICS (T_A=25°C)

Parameter	Symbol	SF 6005PT	SF 6010PT	SF 6020PT	SF 6040PT	SF 6050PT	SF 6060PT	Unit
Marking		SF 6005PT	SF 6010PT	SF 6020PT	SF 6040PT	SF 6050PT	SF 6060PT	
Maximum Repetitive Peak Reverse Voltage	V _{RRM}	50	100	200	400	500	600	
Maximum RMS Voltage	V _{RMS}	35	70	140	280	350	420	V
Maximum DC Blocking Voltage	V _{DC}	50	100	200	400	500	600	
Maximum Average Forward Rectified Current at T _c =110°C	per device	60.0						A
	per diode	30.0						
Peak Forward Surge Current, 8.3ms Single Half Sine-Wave Superimposed On Rated Load	I _{FSM}	250.0						
Maximum Instantaneous Forward Voltage Per Diode at 30.0A	V _F		1.0		1.3	2.2		V
Maximum DC Reverse Current at Rated DC Blocking Voltage	T _A =25°C	10						μA
	T _A =125°C	500						
Maximum Reverse Recovery Time ¹⁾	T _{rr}	35						ns
Typical Thermal Resistance	R _{θJC}	1.5						°C/W
Operating Junction And Storage Temperature Range	T _J , T _{STG}	-55 to +150						°C

Note:

1. Reverse recovery time test condition: I_F=0.5A I_R=1.0A I_{rr}=0.25A

CHARACTERISTIC CURVES

Fig. 1- Derating Curve Output Rectified Current

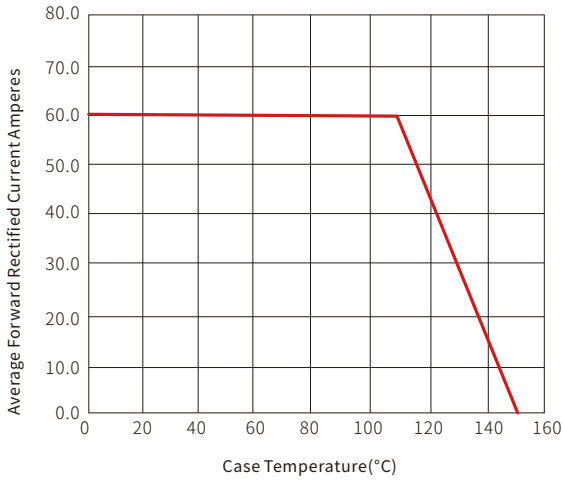

Fig. 2- Maximum Non-Repetitive Peak Forward Surge Current Perleg

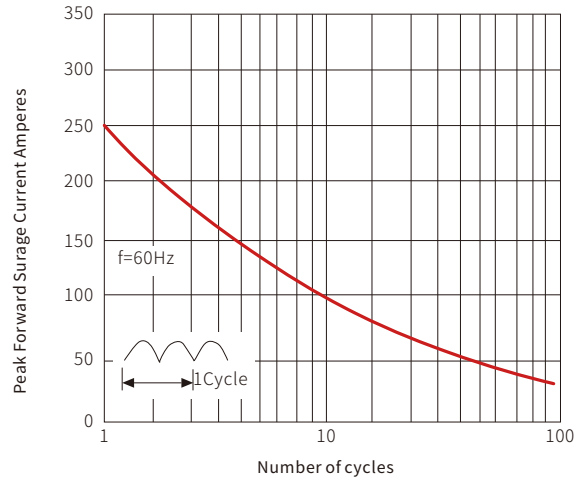

Fig. 3-Typical Forward Voltage Characteristics

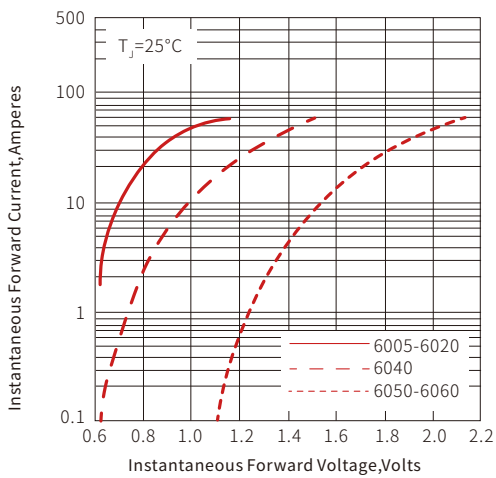
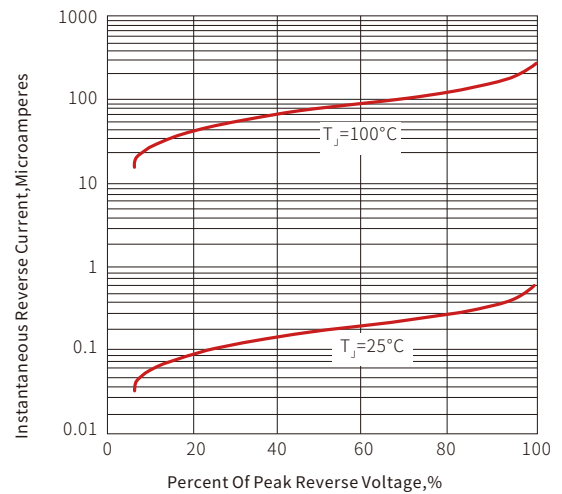
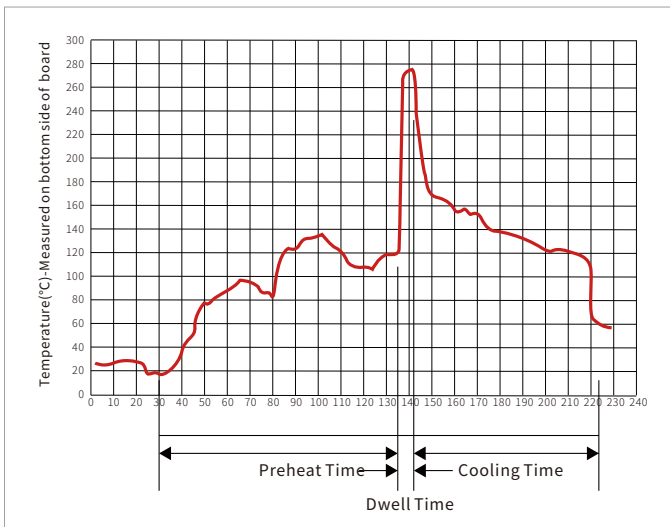

Fig. 4-Typical Reverse Leakage Characteristics



WAVE SOLDERING



Wave Parameter		Lead-free assembly
Pre Heat	Temperature Min	100°C
	Temperature Max	150°C
	Time(min to max)	60 – 180 secs
Solder pot Temperature		280°C Max
Solder Dwell Time		2-5 seconds

TO-247 PACKAGE INFORMATION

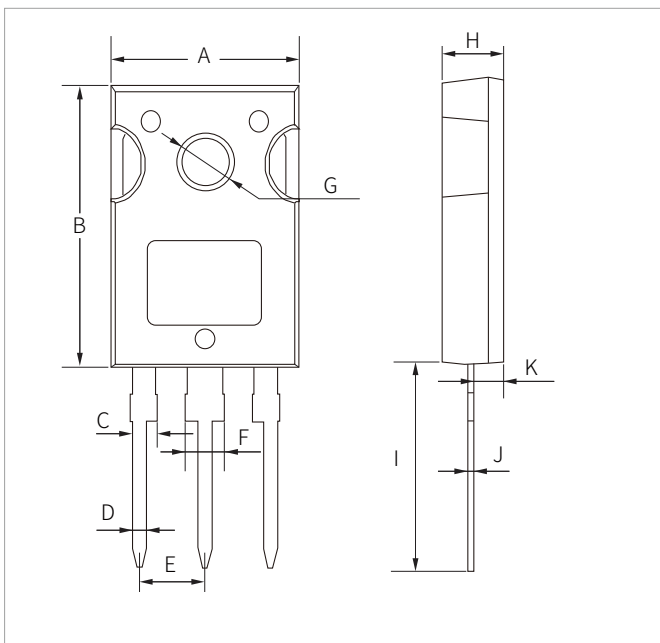

Ref.	Millimeters		Inches	
	Min.	Max.	Min.	Max.
A	15.4	15.8	0.606	0.662
B	19.5	20.5	0.767	0.807
C	1.8	2.2	0.070	0.087
D	1.15	1.25	0.045	0.050
E	5.2	5.7	0.204	0.225
F	2.8	3.2	0.110	0.126
G	3.4	3.8	0.133	0.149
H	4.8	5.0	0.188	0.204
I	14.0	14.5	0.550	0.570
J	0.4	0.7	0.015	0.029
K	2.4		0.095	

ORDERING INFORMATION

Part Number	Component Package	QTY/Tube	QTY/Box	QTY/Carton
SF6005PT-SF6060PT	TO-247	30PCS	450PCS	2250PCS

Headquarters

No.3387 Shendu Road
Pujiang I&E Park
Minhang Shanghai China
201000

Hotline

400-021-5756

Web

<https://www.semiware.com>

Sales Center

Tel: 86-21-3463-7458
Email: sales18@semiware.com

Customer Service

Tel: 86-21-5484-1001
Email: sales17@semiware.com

Technical Support

Tel: 86-21-3463-7654
Email: fae01@semiware.com

Complaint & Suggestions

Tel: 86-21-3463-7172
Ext: 8868
Email: cs03@semiware.com

By QR Code

Website



Wechat

To find your local partner within Semiware's global website: www.semiware.com

© 2022 Semiware Semiconductor Inc.

The content of this document has been carefully checked and understood. However, neither Semiware nor its subsidiaries assume any liability whatsoever for any errors or inaccuracies of this document and the consequences thereof. Published specifications are subject to change without notice. Product suitability for any area of application must ultimately be determined by the customer. In all cases, products must never be operated outside their published specifications. Semiware does not guarantee the availability of all published products. This disclaimer shall be governed by substantive Chinese law and resulting disputes shall be settled by the courts at the place of business of Semiware. Latest publications and a complete disclaimer can be downloaded from the Semiware website. All trademarks recognized.