

## FEATURES

- | Super Fast Switching For High Efficiency
- | Low Reverse Leakage
- | High Forward Surge Current Capability

## PRIMARY USE

- | Mainly Used In Switching Power Supply, PWM Pulse Width Modulator, inverter as A Freewheeling And Other Electronic Circuits, High-Frequency Rectifier Diode, Diode or Damping Diode use

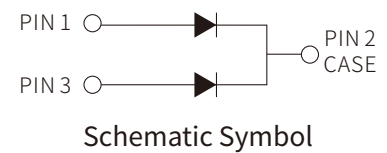
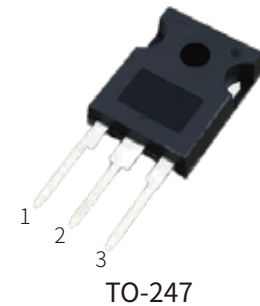

## APPROVALS

<b>RoHS</b>	Compliance with 2011/65/EU
<b>HF</b>	Compliance with IEC61249-2-21:2003

## MAXIMUM RATINGS ( $T_A=25^{\circ}\text{C}$ )

Parameter	Symbol	Value	Unit
Maximal Inverted Repetitive Peak Voltage	$V_{RRM}$	400	V
Average Rectified Forward Current (Rated VR-20Khz Square Wave) - 50% duty cycle	$I_{FAV}$	60	A
Max.forward Surge Current ,8.3ms Single Half Sine-Wave Superimposed On Rated Load	$I_{FSM}$	$340 \times 2$	A
Operating Junction Temperature	$T_J$	-40 to 175	$^{\circ}\text{C}$
Storage Temperature	$T_{STG}$	-40 to 175	$^{\circ}\text{C}$
Typical Thermal Resistance(per leg) Package=TO-247	$R_{\theta JC}$	0.5	$^{\circ}\text{C}/\text{W}$

## ELECTRICAL CHARACTERISTICS( $T_A=25^{\circ}\text{C}$ )

Item	Test Conditions	Min.	Typ.	Max.	Unit
$V_B$	$I_R=100\mu\text{A}, T_J=25^{\circ}\text{C}$	400			V
$I_R$	$V_R=400\text{V}, T_J=25^{\circ}\text{C}$			0.01	mA
	$V_R=400\text{V}, T_J=125^{\circ}\text{C}$			0.10	
$V_F$	$I_F=30\text{A}$ ( $I_{FAV}=30\text{A}\times 2$ )	$T_J=25^{\circ}\text{C}$	1.2	1.4	V
		$T_J=125^{\circ}\text{C}$		1.2	V
$T_{RR}$	$I_F=0.5\text{A}, I_R=1.0\text{A}, I_{REC}=0.25\text{A}$			50	nS

## CHARACTERISTIC CURVES

Fig1: The Forward Voltage And Forward Current Curve

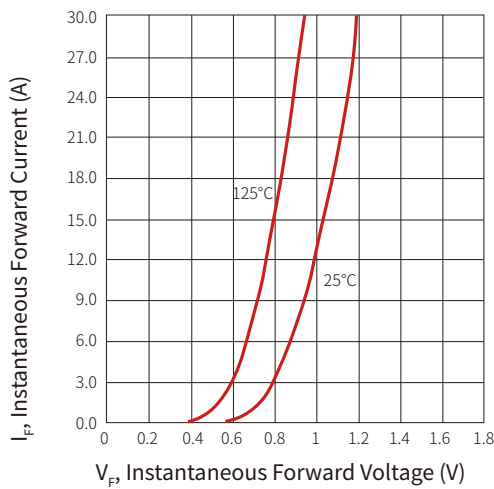
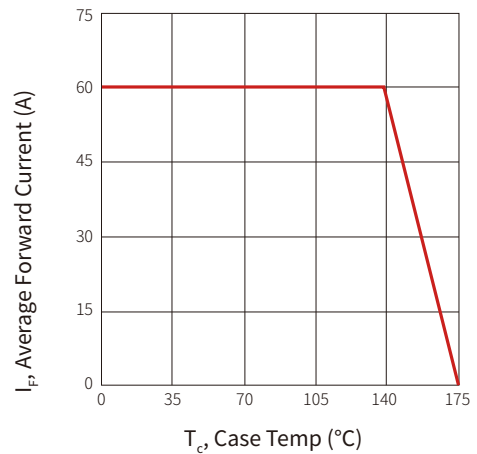
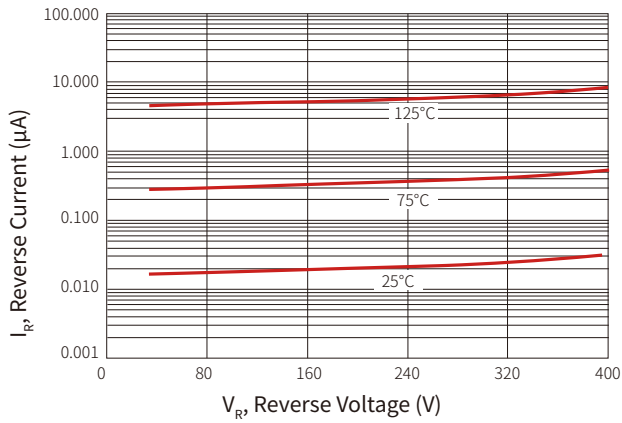
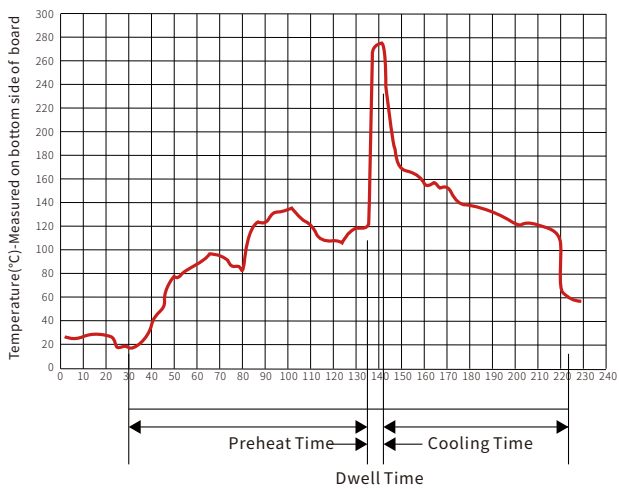

Fig2: Current Derating Curve, Per Element



**FIG3: The Reverse Leak Current And The Reverse Voltage (Single-Device) Curve.**

## WAVE SOLDERING



Wave Parameter		Lead-free assembly
Pre Heat	Temperature Min	100°C
	Temperature Max	150°C
	Time(min to max)	60 – 180 secs
Solder pot Temperature		280°C Max
Solder Dwell Time		2-5 seconds

## TO-247 PACKAGE INFORMATION

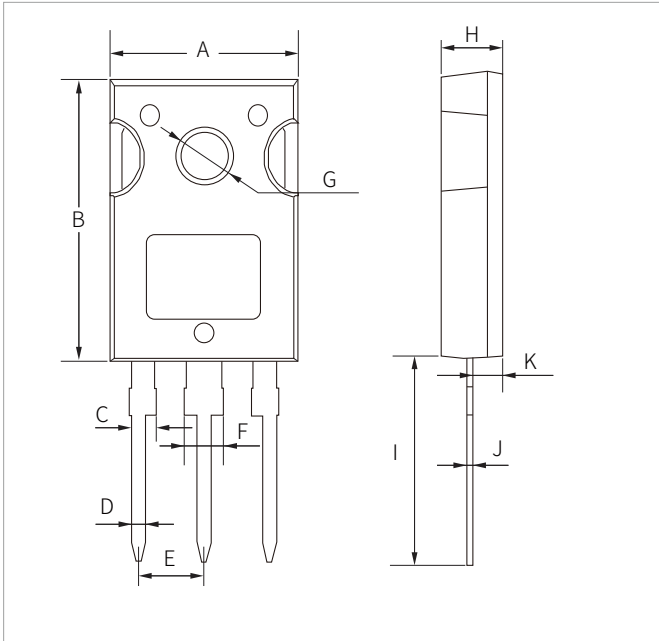

Ref.	Millimeters		Inches	
	Min.	Max.	Min.	Max.
A	15.4	15.8	0.606	0.662
B	19.5	20.5	0.767	0.807
C	1.8	2.2	0.070	0.087
D	1.15	1.25	0.045	0.050
E	5.2	5.7	0.204	0.225
F	2.8	3.2	0.110	0.126
G	3.4	3.8	0.133	0.149
H	4.8	5.0	0.188	0.204
I	14.0	14.5	0.550	0.570
J	0.4	0.7	0.015	0.029
K	2.4		0.095	

## ORDERING INFORMATION

Part Number	Component Package	Marking	QTY/Tube	QTY/Box	QTY/Carton
SFP6004	TO-247	SFP6004	30PCS	450PCS	2250PCS

**Headquarters**

No.3387 Shendu Road  
Pujiang I&E Park  
Minhang Shanghai China  
201000

**Hotline**

400-021-5756

**Web**

<https://www.semiware.com>

**Sales Center**

Tel: 86-21-3463-7458  
Email: [sales18@semiware.com](mailto:sales18@semiware.com)

**Customer Service**

Tel: 86-21-5484-1001  
Email: [sales17@semiware.com](mailto:sales17@semiware.com)

**Technical Support**

Tel: 86-21-3463-7654  
Email: [fae01@semiware.com](mailto:fae01@semiware.com)

**Complaint & Suggestions**

Tel: 86-21-3463-7172  
Ext: 8868  
Email: [cs03@semiware.com](mailto:cs03@semiware.com)

**By QR Code**

Website



Wechat

To find your local partner within Semiware's global website: [www.semiware.com](http://www.semiware.com)

© 2022 Semiware Semiconductor Inc.

The content of this document has been carefully checked and understood. However, neither Semiware nor its subsidiaries assume any liability whatsoever for any errors or inaccuracies of this document and the consequences thereof. Published specifications are subject to change without notice. Product suitability for any area of application must ultimately be determined by the customer. In all cases, products must never be operated outside their published specifications. Semiware does not guarantee the availability of all published products. This disclaimer shall be governed by substantive Chinese law and resulting disputes shall be settled by the courts at the place of business of Semiware. Latest publications and a complete disclaimer can be downloaded from the Semiware website. All trademarks recognized.