

## FEATURES

- | Surface Mounting Design 5.0\*5.0\*4.2mm
- | High Current Handling Capability 5000A @ 8/20  $\mu$ s
- | Low Capacitance and Insertion Loss
- | Quick Response and Long Service Life
- | Moisture sensitivity level: Level 1

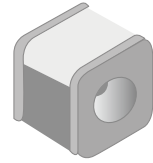

5.0\*5.0\*4.2mm

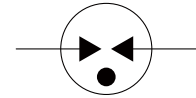



Schematic Symbol

## APPLICATION INFORMATION

- | Communication equipment.
- | Repeaters, Modems
- | Telephone Interface, Line cards.
- | Data communication equipment.

## AGENCY APPROVALS

Icon	Solderability
RoHS	Compliance with 2011/65/EU
HF	Compliance with IEC61249-2-21:2003
	Mean lead free
	UL Certificated E505857

## PRODUCT CHARACTERISTICS

Lead Material	Body Material	Terminal Finish
Copper or Fe-Ni alloy	Ceramics	100% Matte-Tin Plated

## ELECTRICAL PARAMETER

Parameter	Condition	Rating	Unit
DC Blocking Voltage 1)	100V/s	240-360	V
Impulse Spark-over Voltage	At 1kV/ $\mu$ s	for 99 % of measured values $\leq$ 900	V
	At 1kV/ $\mu$ s	Typical values of distribution $\leq$ 850	V
Impulse Discharge Current 2)	8/20 $\mu$ s	5000	A
AC Discharge Current	50Hz, 1S, 10times	5	A
Insulation Resistance	DC=100V	$\geq$ 1	G $\Omega$
Capacitance at 1MHz	V <sub>DC</sub> =0.5V	$\leq$ 0.8	pF
Operating and Storage Temperature		-40-125	°C

1) In ionized mode

2) Terms and waveforms in accordance with ITU-T Rec. K. 12; IEC 61643-21

## ENVIRONMENTAL RELIABILITY CHARACTERISTICS

Testing items	Technical standards
High Temperature Storage Test	Temperature: 85°C ; Time: 2H
Low Temperature Storage Test	Temperature: -40°C ; Time: 2H
Vibration	Frequency: 10-500Hz ; Amplitude: 0.15mm ; Time: 45min
Resistance of soldering heat	Temperature: 260 $\pm$ 5°C ; Time of dip soldering: 10s, 1time

**NOTE:** Up-screen program can be specified by customer's request via contacting Semiware service

## REFLOW PROFILE

Reflow Condition		Lead-free assembly
Pre Heat	Temperature Min	150°C
	Temperature Max	200°C
	Time(min to max)	60-180 secs
Average ramp up rate (Liquidus)Temp ( $T_L$ ) to peak $T_s$ (max) to $T_L$ - Ramp-up Rate		3°C/second max
Reflow	Temperature ( $T_L$ ) (Liquidus)	217°C
	Temperature ( $T_L$ )	60-150 seconds
Peak Temperature ( $T_p$ )		260+0/-5 °C
Time within 5°C of actual peak Temperature ( $t_p$ )		~10 seconds
Ramp-down Rate		6°C/second max
Time 25°C to peak Temperature ( $T_p$ )		8 minutes max.
Do not exceed		260°C

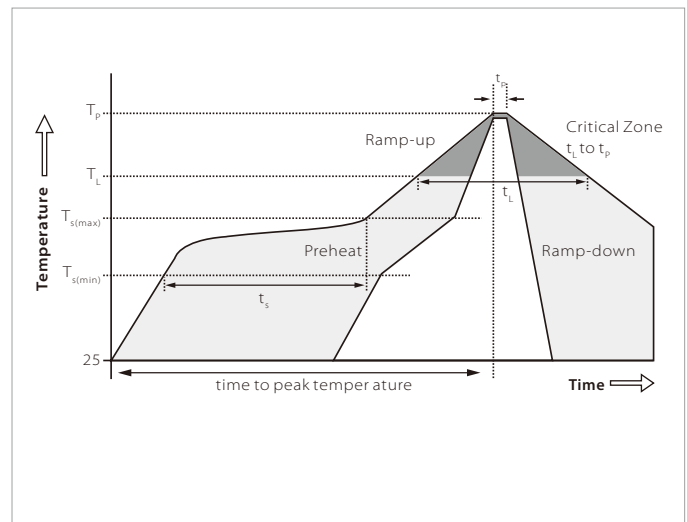

## PRODUCT DIMENSIONS AND RECOMMENDED SOLDERING PAD

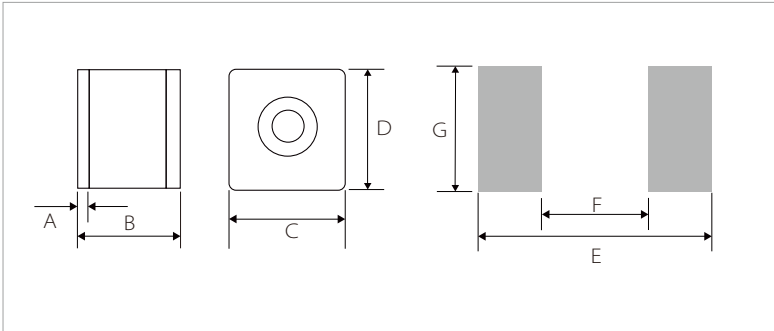

Ref.	mm
A	0.5±0.1
B	4.2±0.3
C	5.0±0.2
D	5.0±0.2
E	4.7
F	2.5
G	5.5

## PACKAGE REEL INFORMATION

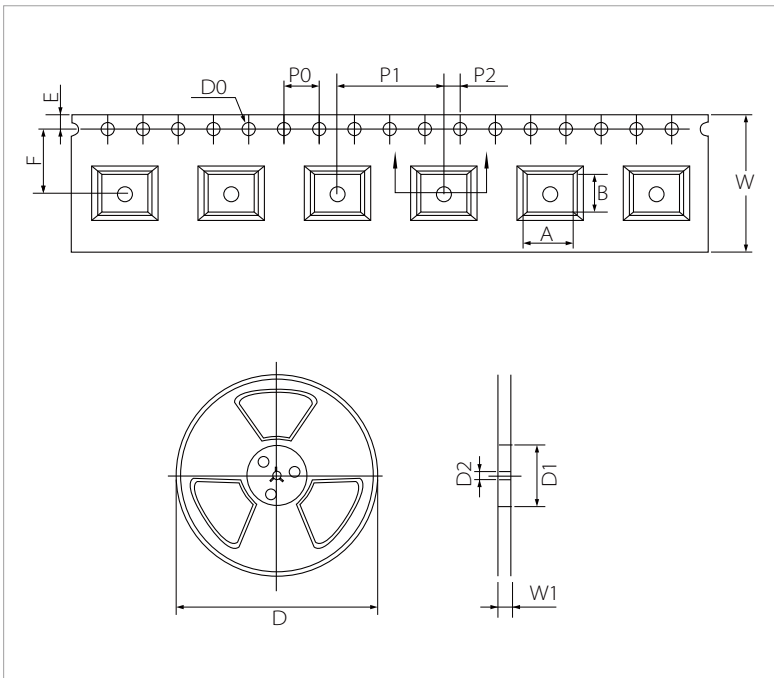

Ref.	mm	inch
A	5.5±0.1	0.217±0.004
B	4.7±0.2	0.185±0.008
D0	Φ 1.5±0.1	Φ 0.059±0.004
P0	4.0±0.1	0.157±0.004
P1	12.0±0.1	0.472±0.004
P2	2.0±0.1	0.079±0.004
E	1.75±0.1	0.069±0.004
F	7.5±0.1	0.295±0.004
W	16.0±0.3	0.630±0.012
D	Φ 330.0	Φ 13.0
D1	Φ 50Min	Φ 1.97Min
D2	Φ 13±0.15	0.512±0.006
W1	16.8±2.0	0.661±0.079

## ORDERING INFORMATION

Part Number	Size	QTY/Reel	Reel Size
SG5042B300	5.0*5.0*4.2mm	1000	13"

**Headquarters**

No.3387 Shendu Road Pujiang  
I&E Park  
Minhang Shanghai China  
201000

**Hotline**

400-021-5756

**Web**

<https://www.semiware.com>

**Sales Center**

Tel: 86-21-3463-7458  
Email: [sales18@semiware.com](mailto:sales18@semiware.com)

**Customer Service**

Tel: 86-21-5484-1001  
Email: [sales17@semiware.com](mailto:sales17@semiware.com)

**Technical Support**

Tel: 86-21-3463-7654  
Email: [fae01@semiware.com](mailto:fae01@semiware.com)

**Complaint & Suggestions**

Tel: 86-21-3463-7172  
Ext: 8868  
Email: [cs03@semiware.com](mailto:cs03@semiware.com)

**By QR Code**

Website



Wechat

To find your local partner within Semiware's global network: [www.semiware.com](http://www.semiware.com)

© 2022 Semiware Semiconductor Inc.

The content of this document has been carefully checked and understood. However, neither Semiware nor its subsidiaries assume any liability whatsoever for any errors or inaccuracies of this document and the consequences thereof. Published specifications are subject to change without notice. Product suitability for any area of application must ultimately be determined by the customer. In all cases, products must never be operated outside their published specifications. Semiware does not guarantee the availability of all published products. This disclaimer shall be governed by substantive Chinese law and resulting disputes shall be settled by the courts at the place of business of Semiware. Latest publications and a complete disclaimer can be downloaded from the Semiware website. All trademarks recognized.