

FEATURES

- | Surface-mounted package
- | Low Thermal Resistance

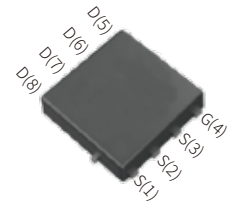

PDFN5×6-8L

APPLICATION

- | Motor drivers
- | DC - DC Converter

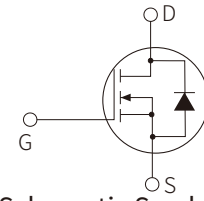

Schematic Symbol

APPROVALS

RoHS	Compliance with 2011/65/EU
HF	Compliance with IEC61249-2-21:2003

ABSOLUTE MAXIMUM RATINGS

Parameter	Symbol	Value	Unit
Drain-Source Voltage $T_c=25^\circ\text{C}$	V_{DS}	40	V
Drain Current (Pulsed) $T_c=25^\circ\text{C}$ $V_{GS}=10\text{V}$	I_{DM}^{**}	800	A
Drain Current (DC)	I_D^*	$T_c=25^\circ\text{C}$ $V_{GS}=10\text{V}$	178
		$T_c=100^\circ\text{C}$ $V_{GS}=10\text{V}$	126
Gate-Source Voltage $T_c=25^\circ\text{C}$	V_{GS}	± 20	V
Drain power dissipation $T_c=25^\circ\text{C}$	P_{tot}	93	W
Continuous-Source Current $T_c=25^\circ\text{C}$	I_S	178	A
Single Pulsed Avalanche Energy $V_{DD}=40\text{V}$, $L=1.0\text{mH}$	E_{AS}^*	544	mJ
Junction Temperature	T_J	175	$^\circ\text{C}$
Storage Temperature	T_{STG}	-55 to 175	$^\circ\text{C}$
Thermal Resistance – Junction to Ambient	$R_{\theta JA}^*$	62.5	$^\circ\text{C}/\text{W}$
Thermal Resistance- Junction to Case	$R_{\theta JC}^{**}$	1.6	$^\circ\text{C}/\text{W}$

Notes:

 * Surface Mounted on 1 in² pad area, $t \leq 10$ sec

 ** Pulse width $\leq 300\mu\text{s}$, duty cycle $\leq 2\%$

** limited by bonding wire

ELECTRICAL CHARACTERISTICS (T_A=25°C)

Parameter	Symbol	Test Conditions	Min.	Typ.	Max.	Unit
Static Characteristics						
Drain-source Breakdown Voltage	BV _{DSS}	V _{GS} =0V, I _{DS} =250μA	40			V
Gate Threshold Voltage	V _{GS(th)}	V _{DS} =V _{GS} , I _{DS} =250μA	1		2	V
Drain Leakage Current	I _{DSS}	V _{DS} =32V, V _{GS} =0V			1	μA
Gate Leakage Current	I _{GSS}	V _{GS} =±20V, V _{DS} =0V			±100	nA
On-State Resistance	R _{DS(on)} ^a	V _{GS} =10V, I _{DS} =30A		1.0	1.3	mΩ
		V _{GS} =4.5V, I _{DS} =20A		2.2	2.6	mΩ
Diode Characteristics						
Diode Forward Voltage	V _{SD} ^a	I _{SD} =30A, V _{GS} =0V			1.3	V
Reverse Recovery Time	t _{rr}	I _{DS} =30A, V _{GS} =0V dI _{SD} /dt=100A/μs		45		ns
Reverse Recovery Charge	Q _{rr}			26		nC
Dynamic Characteristics^b						
Input capacitance	C _{iss}	V _{GS} =0V, V _{DS} =20V, Frequency = 1 MHz		2838		pF
Output capacitance	C _{oss}			1233		pF
Reverse transfer capacitance	C _{rss}			123		pF
Turn-on Delay Time	t _{d(on)}	V _{DS} =20V, V _{GEN} =10V R _G =3.9Ω, R _L =0.66Ω, I _{DS} =30A		10		nS
Turn-on Rise Time	t _r			68		nS
Turn-Off Delay Time	t _{d(off)}			51		nS
Turn-Off Fall Time	t _f			46		nS
Gate Charge Characteristics^b						
Total Gate Charge	Q _g	V _{DS} =20V, V _{GS} =10V, I _{DS} =30A		58		nC
Gate-Source Charge	Q _{gs}			11		nC
Gate-Drain Charge	Q _{gd}			15		nC

Notes:

a : Pulse test ; pulse width ≤ 300μs, duty cycle ≤ 2 %

b : Guaranteed by design, not subject to production testing

PARAMETER CHARACTERISTIC CURVE

Figure1: Power Capability

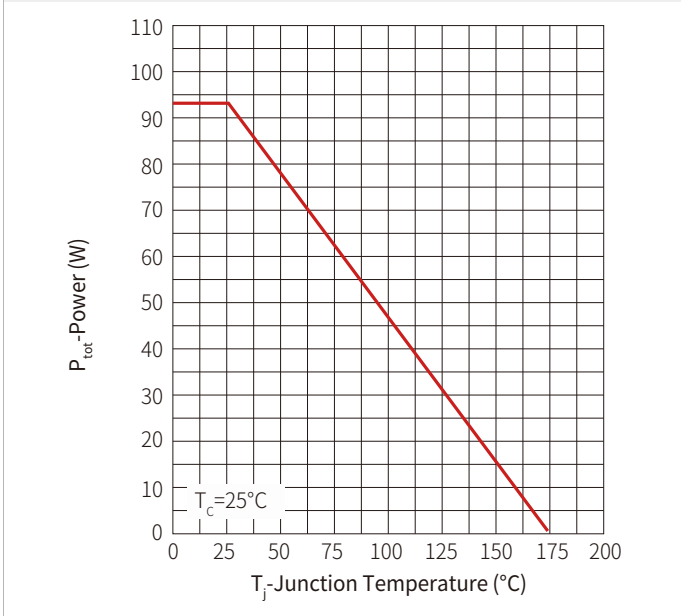

Figure2: Current Capability

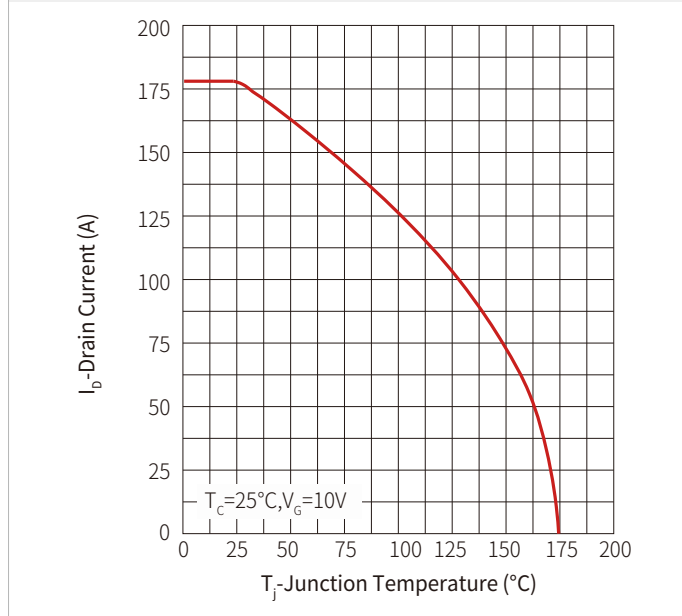

Figure3: Safe operating Area

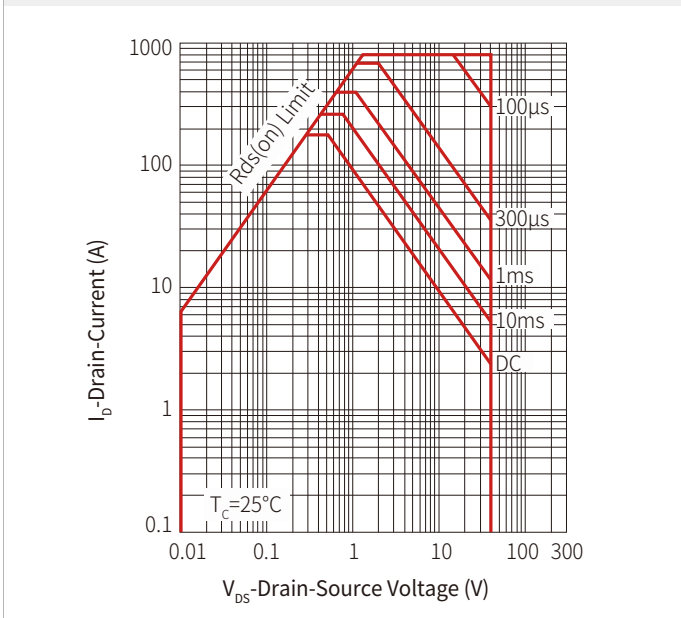

Figure 4: Transient Thermal Impedance

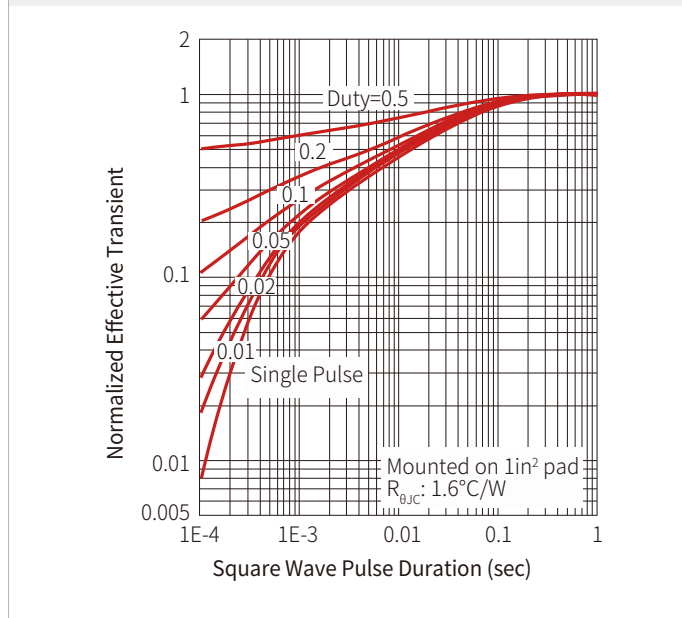

Figure 5: Output Characteristics

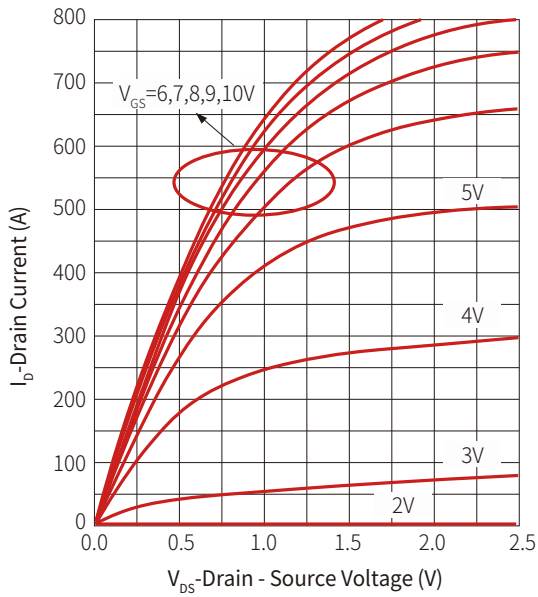

Figure 6: Drain-Source On Resistance

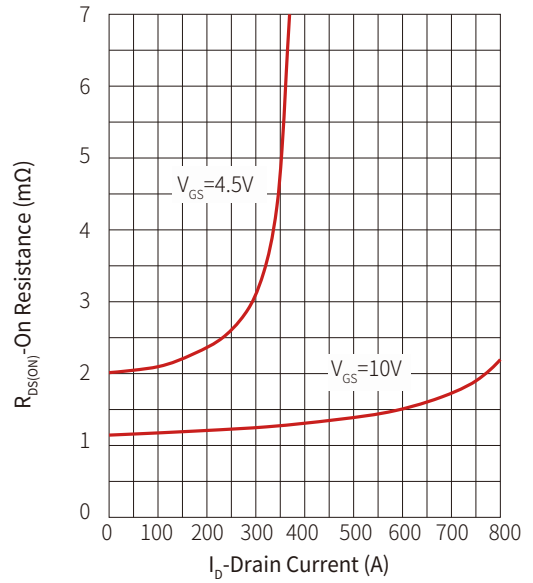

Figure 7: Transfer Characteristics

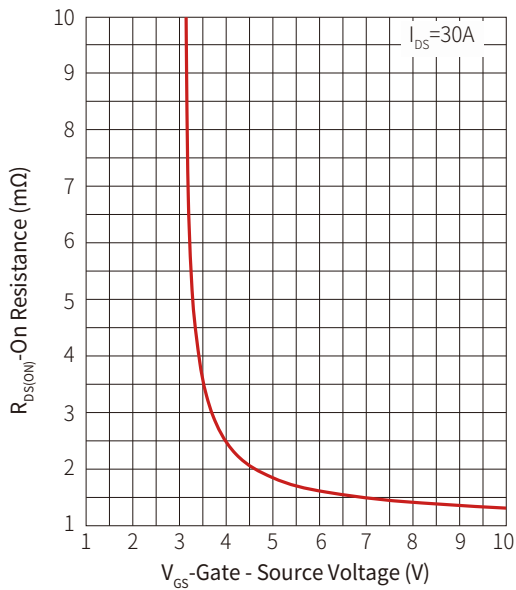

Figure 8: Gate Threshold Voltage

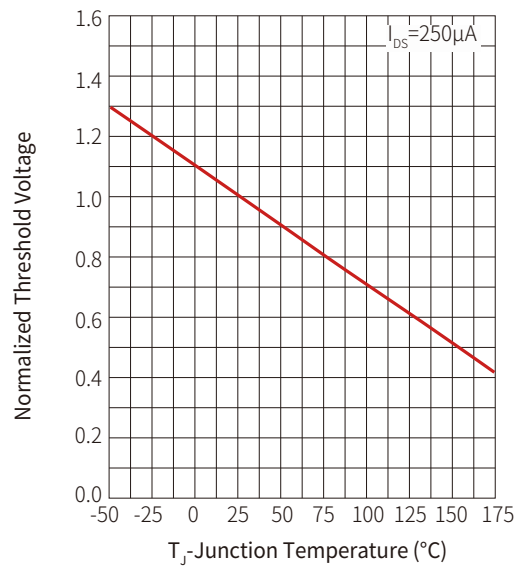

Figure 9: Normalized On Resistance

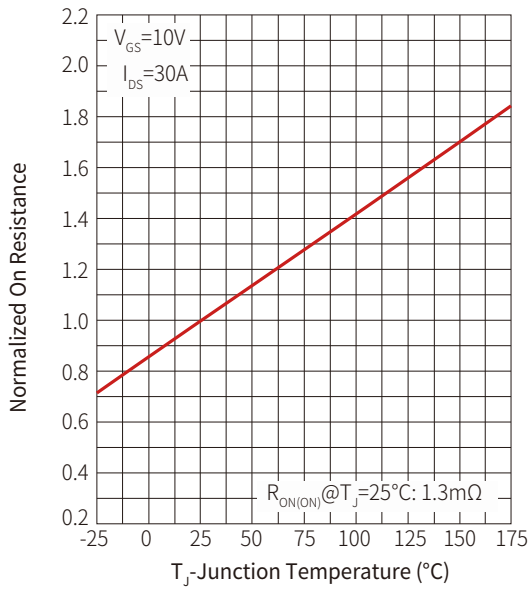

Figure 10: Body Diode Characteristics

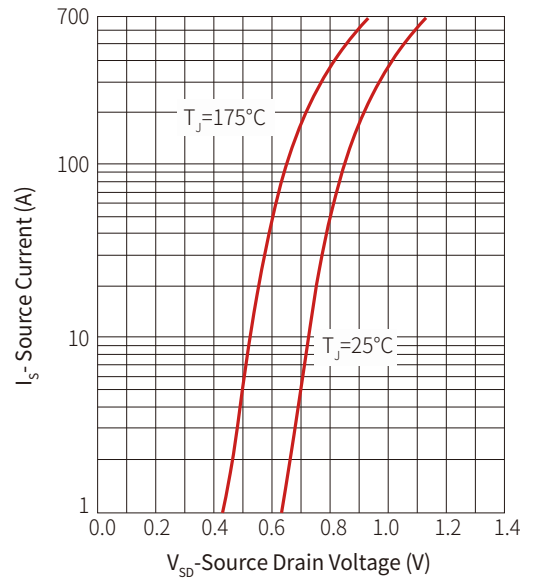

Figure 11: Capacitance

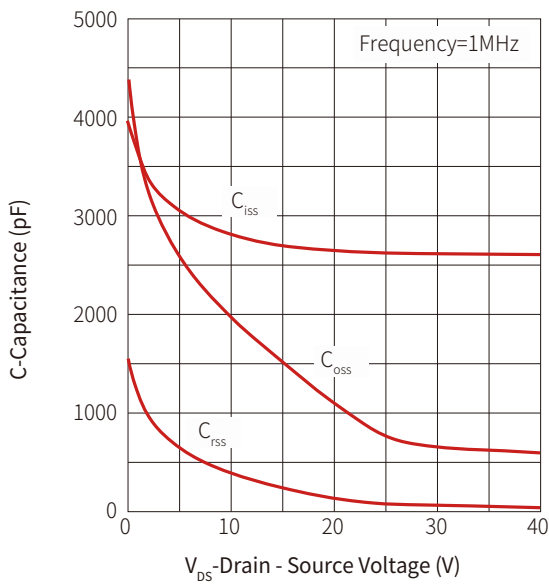
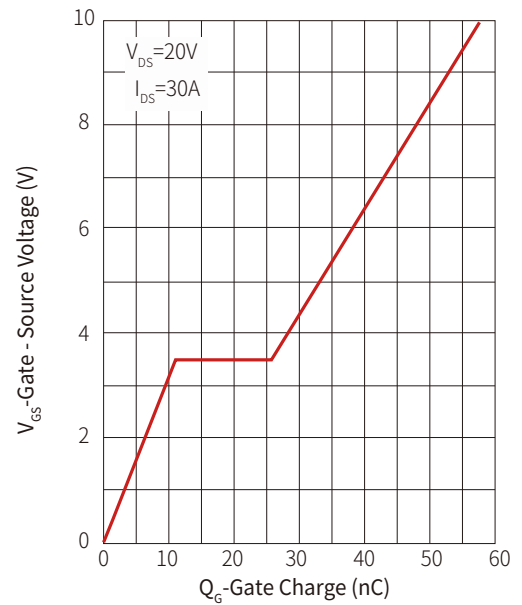
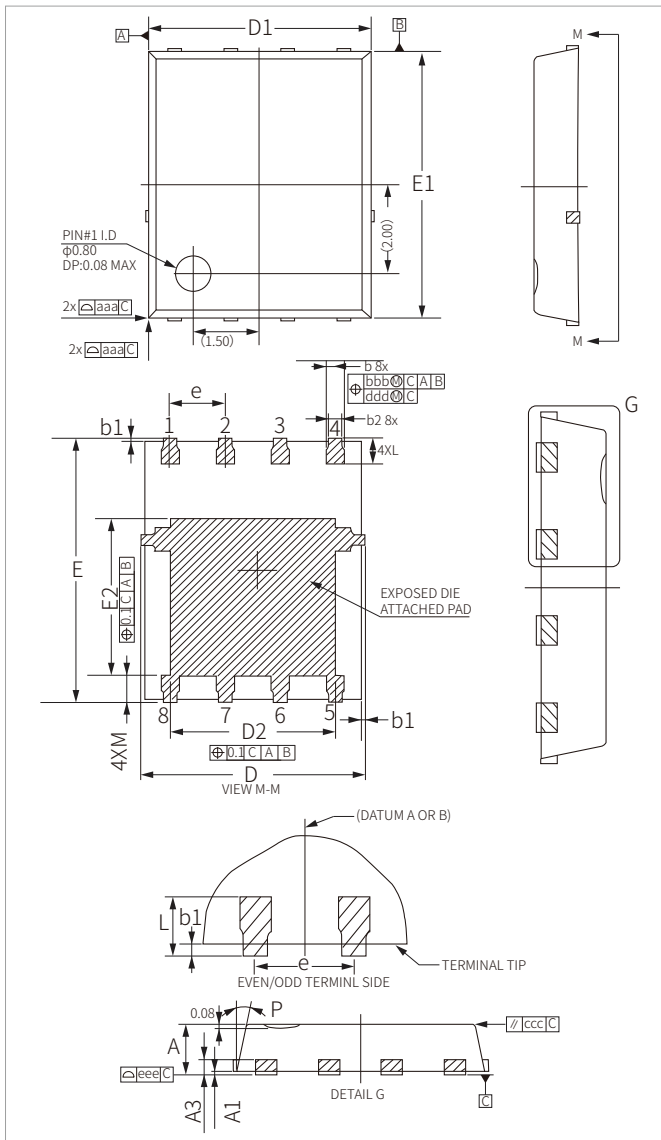

Figure 12: Gate Charge



PDFN5×6-8L PACKAGE INFORMATION



Ref.	Millimeters		Inches	
	Min.	Max.	Min.	Max.
A	0.90	1.17	0.035	0.046
A1	0.00	0.05	0.000	0.002
A3	0.254REF		0.010REF	
b	0.31	0.51	0.012	0.020
b1	0.03	0.13	0.001	0.005
b2	0.21	0.41	0.008	0.016
D	5.15BSC		0.203BSC	
D1	5.00BSC		0.197BSC	
D2	3.70	3.90	0.146	0.154
E	6.15BSC		0.242BSC	
E1	6.00BSC		0.236BSC	
E2	3.56	3.76	0.140	0.148
e	1.27BSC		0.050BSC	
L	0.51	0.71	0.020	0.028
M	0.51	0.71	0.020	0.028
P	10°	12°	0.394°	0.472°
aaa	0.10		0.004	
bbb	0.10		0.004	
ccc	0.10		0.004	
ddd	0.05		0.002	
eee	0.08		0.003	

ORDERING INFORMATION

Part Number	Component Package	Marking	QTY/Reel	Reel Size
SNM014N04G	PDFN5×6-8L	 014N04 XXXX	5000PCS	13"

Headquarters

No.3387 Shendu Road
Pujiang I&E Park
Minhang Shanghai China
201000

Hotline

400-021-5756

Web

<https://www.semiware.com>

Sales Center

Tel: 86-21-3463-7458
Email: sales18@semiware.com

Customer Service

Tel: 86-21-5484-1001
Email: sales17@semiware.com

Technical Support

Tel: 86-21-3463-7654
Email: fae01@semiware.com

Complaint & Suggestions

Tel: 86-21-3463-7172
Ext: 8868
Email: cs03@semiware.com

By QR Code

Website



Wechat

To find your local partner within Semiware's global website: www.semiware.com

© 2022 Semiware Semiconductor Inc.

The content of this document has been carefully checked and understood. However, neither Semiware nor its subsidiaries assume any liability whatsoever for any errors or inaccuracies of this document and the consequences thereof. Published specifications are subject to change without notice. Product suitability for any area of application must ultimately be determined by the customer. In all cases, products must never be operated outside their published specifications. Semiware does not guarantee the availability of all published products. This disclaimer shall be governed by substantive Chinese law and resulting disputes shall be settled by the courts at the place of business of Semiware. Latest publications and a complete disclaimer can be downloaded from the Semiware website. All trademarks recognized.