

FEATURES

Ultra low on-resistance: $V_{DS}=30V, R_{DS(ON)} \leq 52m\Omega$

@ $V_{GS}=10V, I_D=4.2A$

For PWM application

For Load switch application

Surface Mount device

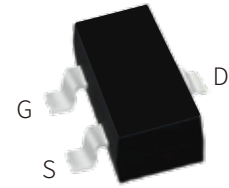

SOT-23

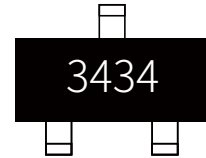

Marking

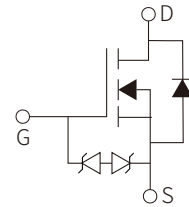

Schematic Symbol

APPLICATION

Case: SOT-23

Case Material: Molded Plastic. UL flammability

Classification Rating: 94V-0

APPROVALS

RoHS Compliance with 2011/65/EU

HF Compliance with IEC61249-2-21:2003

ABSOLUTE MAXIMUM RATINGS($T_a=25^\circ\text{C}$)

Parameter	Symbol	Value	Unit
Drain-Source Voltage	V_{DS}	30	V
Drain Current-Continuous	I_D	3.5	A
Drain Current-Continuous	I_D	2.8	A
Pulsed Drain Voltage	I_{DM}	30	A
Gate-Source Voltage	V_{GS}	± 20	V
Total Power Dissipation	P_D	1.0	W
Total Power Dissipation	P_D	0.64	W
Thermal resistance from Junction to ambient	$R_{\theta JA}$	125	$^\circ\text{C}/\text{W}$
Junction temperature	T_J	150	$^\circ\text{C}$
Storage temperature	T_{STG}	-55 to 150	$^\circ\text{C}$

ELECTRICAL CHARACTERISTICS(T_a=25°C)

Parameter	Symbol	Test Conditions	Min.	Typ.	Max.	Unit
Drain-source Breakdown Voltage*	BV _{DSS}	V _{GS} =0V, I _D =250μA	30			V
Zero Gate Voltage Drain Current*	I _{DSS}	V _{DS} =30V, V _{GS} =0V			1	μA
Gate-Body Leakage*	I _{GSS}	V _{GS} =±16V, V _{DS} =0V			±10	uA
Gate Threshold Voltage*	V _{GS(th)}	V _{DS} =V _{GS} , I _D =250μA	1	1.32	1.8	V
Static Drain-Source On-Resistance*	R _{DS(on)}	V _{GS} =10V, I _D =4.2A		43	52	mΩ
		V _{GS} =10V, I _D =4.2A, T _J =125°C		58	74	
		V _{GS} =4.5V, I _D =2A		59	75	
Forward Transconductance	g _{FS}	V _{DS} =5V, I _D =4.2A		8.5		S
Gate resistance	R _g	V _{GS} =0V, V _{DS} =0V, f=1MHz		1	1.5	Ω
Input Capacitance	C _{iss}	V _{DS} =15V, V _{GS} =0V, f=1.0MHz		269	340	pF
Output Capacitance	C _{oss}			65		
Reverse Transfer Capacitance	C _{rss}			41		
Turn-On Delay Time	t _{d(on)}	V _{GS} =10V, R _L =3.6Ω V _{DS} =15V, R _{GEN} =3Ω		2.6	3.8	ns
Turn-On Rise Time	t _r			5.5	8	
Turn-Off Delay Time	t _{d(off)}			15.2	23	
Turn-Off Fall Time	t _f			3.7	5.5	
Diode forward voltage	V _{SD}	I _S =1A, V _{GS} =0V		0.77	1	V
Total Gate Charge	Q _g	V _{GS} =10V, V _{DS} =15V, I _D =4.2A		5.7	7.2	nC
Gate Source Charge	Q _{gs}			1.37		
Gate Drain Charge	Q _{gd}			0.65		
Diode forward current	I _S				1.8	A
Body Diode Reverse Recovery Time	t _{rr}	I _F =4.2A, di/dt=100A/us		15.5	21	ns
Body Diode Reverse Recovery Charge	Q _{rr}	I _F =4.2A, di/dt=100A/us		7.1		nC

*Pulse test ; Pulse width ≤300μs, Duty cycle ≤ 0.5%

PARAMETER CHARACTERISTIC CURVE

Fig 1: On-Region Characteristics

Figure 2: Transfer Characteristics

Figure 3: On-Resistance vs. Drain Current and Gate Voltage

Figure 4: On-Resistance vs. Junction Temperature

Figure 5: On-Resistance vs. Gate-Source Voltage

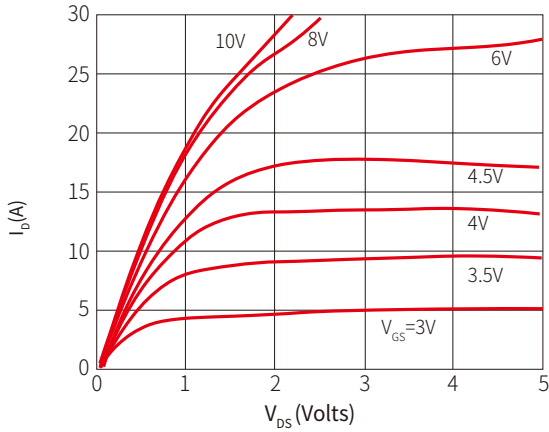
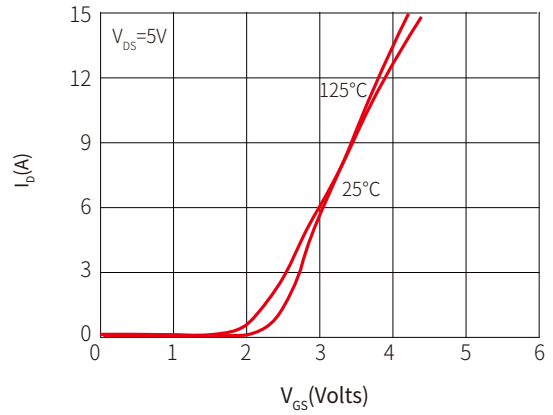
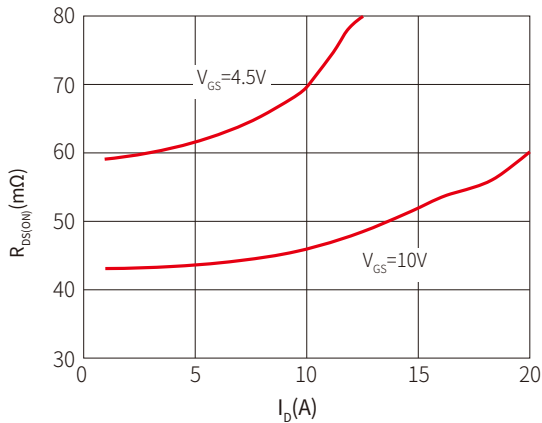
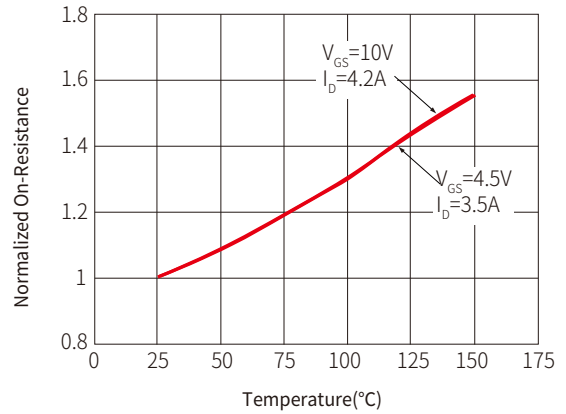
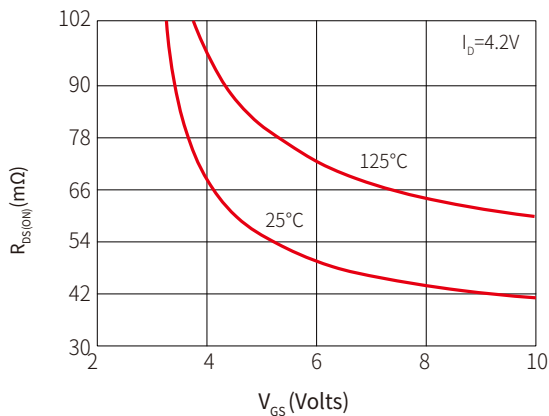
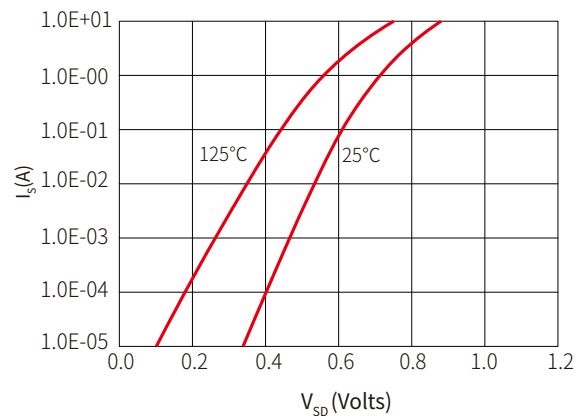
Figure 6: Body-Diode Characteristics

Figure 7: Gate-Charge Characteristics

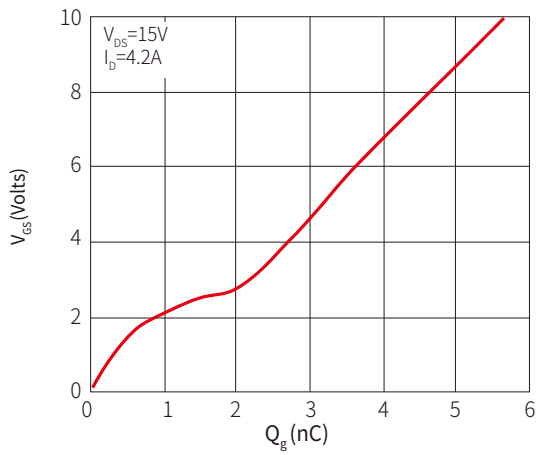

Figure 8: Capacitance Characteristics

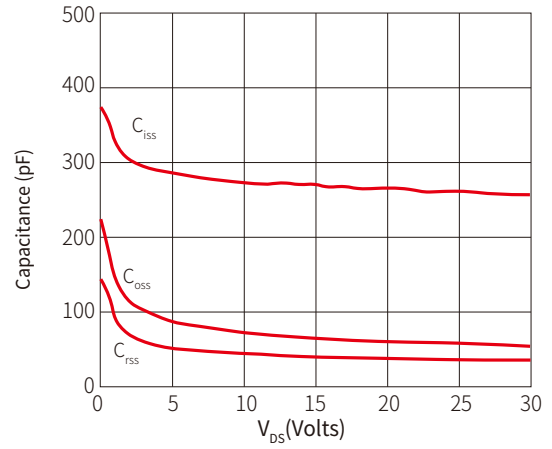

Figure 9: Maximum Forward Biased Safe Operating Area

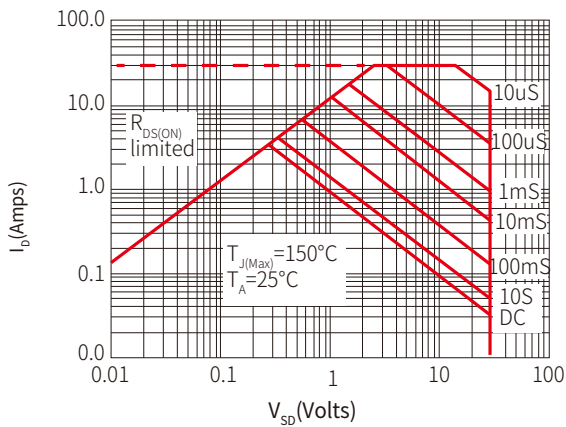

Figure 10: Single Pulse Power Rating Junction-to-Ambient

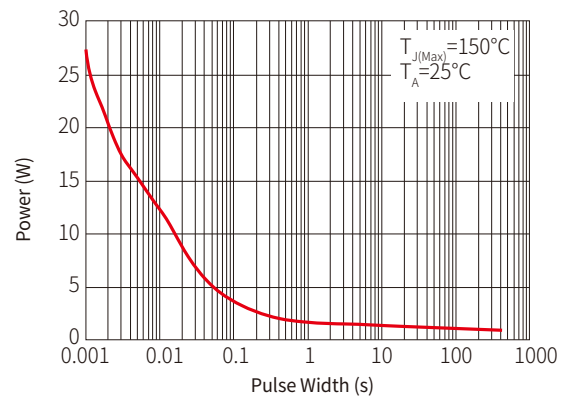
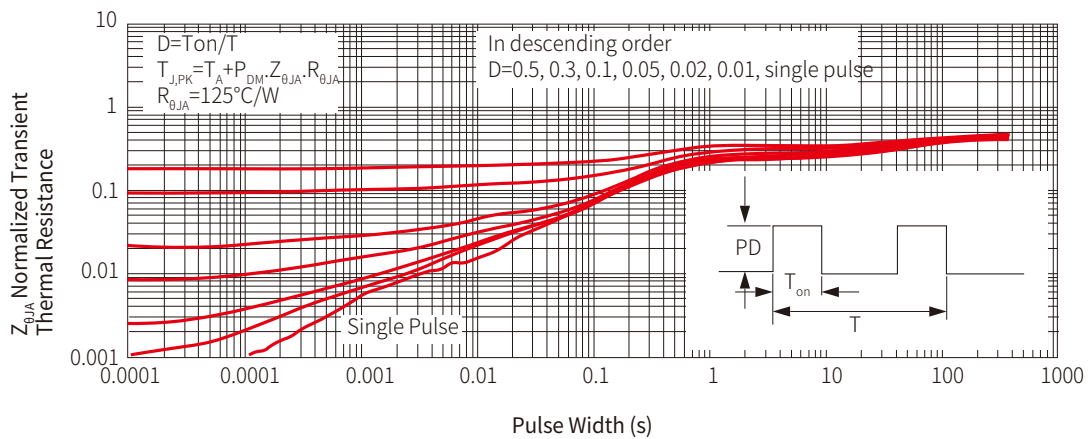
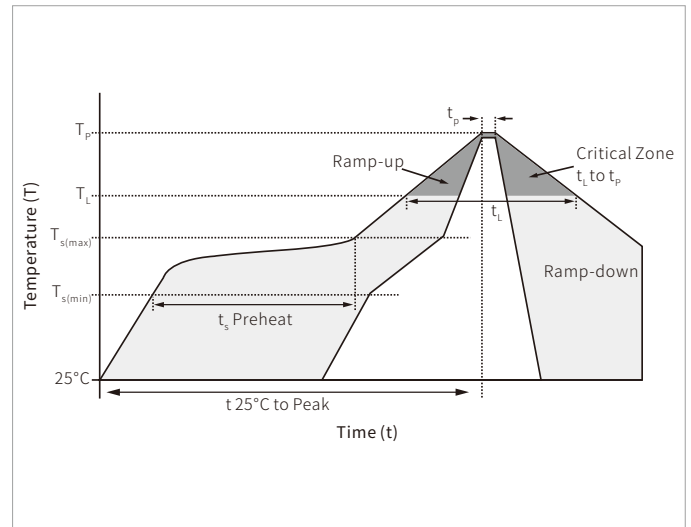

Figure 11: Normalized Maximum Transient Thermal Impedance



SOLDERING PARAMETERS

Reflow Condition		Lead-free assembly
Pre Heat	Temperature Max ($T_{s(min)}$)	150°C
	Temperature Max ($T_{s(max)}$)	200°C
	Time (min to max) (t_s)	60 – 180 secs
Average ramp up rate (Liquidus Temp (T_L) to peak)		3°C/second max
$T_{s(max)}$ to T_L - Ramp-up Rate		3°C/second max
Reflow	Temperature (T_L) (Liquidus)	217°C
	Time (min to max) (t_L)	60 – 150 seconds
Peak Temperature (T_p)		260°C
Time within 5°C of actual peak Temperature (t_p)		20 – 40 seconds
Ramp-down Rate		6°C/second max
Time 25°C to peak Temperature (T_p)		8 minutes max.
Do not exceed		260°C



SOT-23 PACKAGE INFORMATION

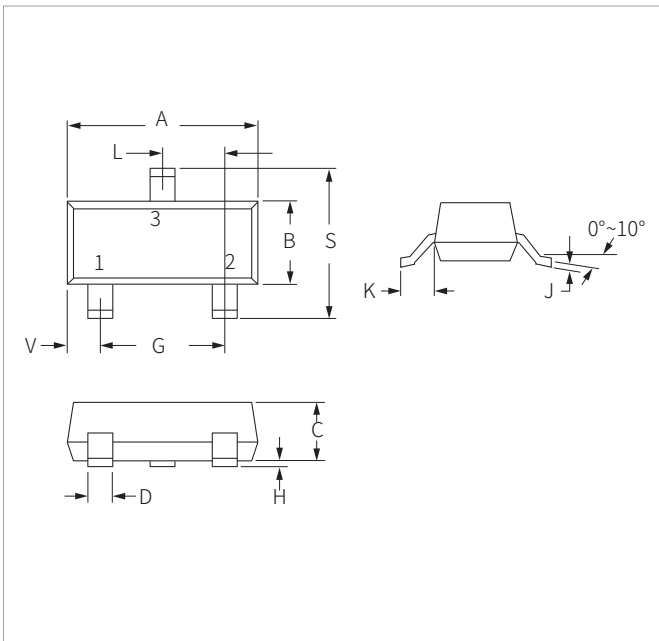

Ref.	Millimeters		Inches	
	Min.	Max.	Min.	Max.
A	2.80	3.05	0.110	0.120
B	1.20	1.40	0.047	0.055
C	0.90	1.15	0.035	0.045
D	0.37	0.50	0.015	0.020
G	1.75	2.05	0.069	0.081
H	0.01	0.100	0.001	0.004
J	0.085	0.180	0.003	0.007
K	0.35	0.69	0.014	0.029
L	0.89	1.02	0.035	0.040
S	2.10	2.65	0.083	0.104
V	0.45	0.60	0.018	0.024

RECOMMENDED PAD LAYOUT DIMENSIONS

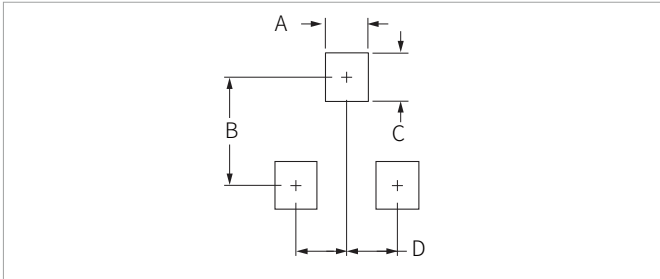

Ref.	Millimeters		Inches	
	Min.	Max.	Min.	Max.
A	0.71	0.97	0.028	0.038
B	1.88	2.13	0.074	0.084
C	0.71	0.97	0.028	0.038
D	0.81	1.07	0.032	0.042

ORDERING INFORMATION

Part Number	Component Package	QTY/Reel	Reel Size
SNM3434S	SOT-23	3000PCS	7"

Headquarters

No.3387 Shendu Road
Pujiang I&E Park
Minhang Shanghai China
201000

Hotline

400-021-5756

Web

<https://www.semiware.com>

Sales Center

Tel: 86-21-3463-7458
Email: sales18@semiware.com

Customer Service

Tel: 86-21-5484-1001
Email: sales17@semiware.com

Technical Support

Tel: 86-21-3463-7654
Email: fae01@semiware.com

Complaint & Suggestions

Tel: 86-21-3463-7172
Ext: 8868
Email: cs03@semiware.com

By QR Code

Website



Wechat

To find your local partner within Semiware' s global website: www.semiware.com

© 2022 Semiware Semiconductor Inc.

The content of this document has been carefully checked and understood. However, neither Semiware nor its subsidiaries assume any liability whatsoever for any errors or inaccuracies of this document and the consequences thereof. Published specifications are subject to change without notice. Product suitability for any area of application must ultimately be determined by the customer. In all cases, products must never be operated outside their published specifications. Semiware does not guarantee the availability of all published products. This disclaimer shall be governed by substantive Chinese law and resulting disputes shall be settled by the courts at the place of business of Semiware. Latest publications and a complete disclaimer can be downloaded from the Semiware website. All trademarks recognized.