

FEATURES

- | High Density Cell Design For Low $R_{DS(On)}$
- | Voltage Controlled Small Signal Switch
- | Rugged and Reliable
- | High Saturation Current Capability
- | Lead free product is acquired
- | ESD protected

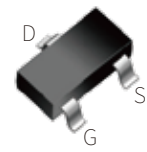

SOT-323

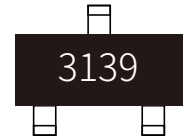

Marking

APPLICATION

- | Direct logic-level interface: TTL/CMOS
- | Drivers: relays, solenoids, lamps
- | hammers, display, memories, etc.
- | Battery operated systems
- | Solid-state relays

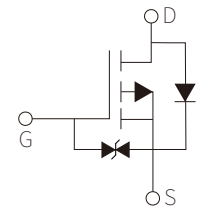

Schematic Symbol

APPROVALS

RoHS	Compliance with 2011/65/EU
HF	Compliance with IEC61249-2-21:2003

ABSOLUTE MAXIMUM RATINGS ($T_A=25^{\circ}\text{C}$)

Parameter	Symbol	Value	Unit
Drain-Source Voltage	V_{DSS}	-20	V
Gate-Source Voltage	V_{GS}	± 10	V
Continuous Drain Current	I_D	-1.5	A
Pulsed Drain Current ($t_p=10\mu\text{s}$)	I_{DM}	-3.0	A
Power Dissipation	P_D	0.38	W
Junction Temperature	T_J	-50- +150	$^{\circ}\text{C}$
Storage Temperature	T_{STG}	-50- +150	$^{\circ}\text{C}$
Thermal Resistance from Junction to Ambient	$R_{\theta JA}$	431	$^{\circ}\text{C}/\text{W}$

ELECTRICAL CHARACTERISTICS (T_A=25°C)

Parameter	Symbol	Test Conditions	Min	Typ	Max	Unit
Off Characteristics						
Drain-source Breakdown Voltage	V _{(BR)DSS}	V _{GS} =0V, I _D =-250μA	-20			V
Gate-source leakage ^a	I _{GSS}	V _{DS} =0V, V _{GS} =±10V			±10	μA
Zero gate voltage drain current	I _{DSS}	V _{DS} =-20V, V _{GS} =0V			-1	μA
Off Characteristics (Note 1)						
Gate-source threshold voltage	V _{GS(th)}	V _{DS} =V _{GS} , I _D =-250μA	-0.5	-0.7	-1.0	V
Drain-source on-state resistance ^a	R _{DS(on)}	V _{GS} =-4.5V, I _D =-0.5A		130	170	mΩ
		V _{GS} =-2.5V, I _D =-0.3A		180	235	mΩ
		V _{GS} =-1.8V, I _D =-0.2A		300	460	mΩ
Charges And Capacitances (Note 3)						
Input capacitance	C _{iss}	V _{DS} =-8.0V, V _{GS} =0V, f=1MHz		640		pF
Output capacitance	C _{oss}			120		pF
Reverse transfer capacitance	C _{rss}			82		pF
Switching Characteristics (Note 2,3)						
Total gate charge	Q _g	V _{DS} =-10V, V _{GS} =-2.5V, I _D =-3.0A		3.3	6	nC
Gate-source charge	Q _{gS}			0.7		nC
Gate-drain charge	Q _{gD}			1.3		nC
Turn-on delay time	t _{d(on)}	V _{GS} =-4.5V, V _{DD} =-4.0V, I _D =-1.0A, R _G =6.2Ω		6.2		ns
Rise Time	t _r			15		ns
Turn-Off Delay Time	t _{d(off)}			26		ns
Fall yime	t _f			18		ns
Drain-source Body Diode Characteristics						
Forward Diode Voltage	V _{SD}	V _{GS} =0V, I _S =-0.3A		-0.62	-1.2	V

Notes:

1. Pulse Test : pulse width ≤300μs, duty cycle ≤2%.
2. Switching characteristics are independent of operating junction temperatures.
3. These parameters have no way to verify.

CHARACTERISTIC CURVES

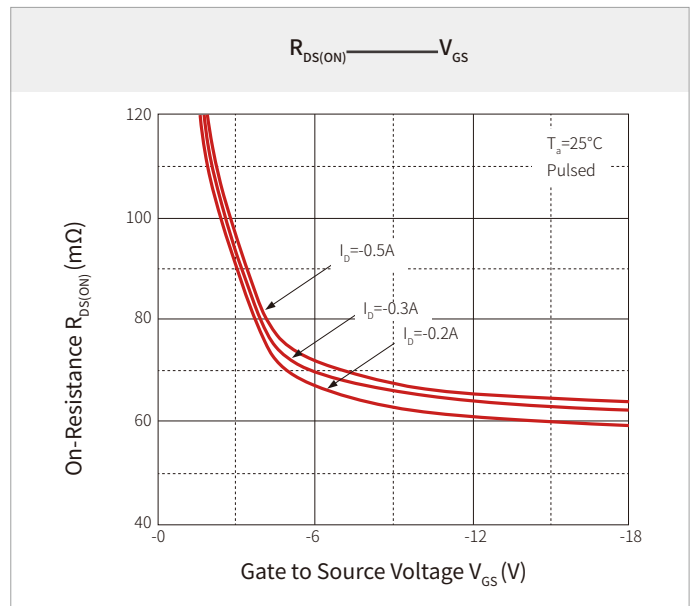
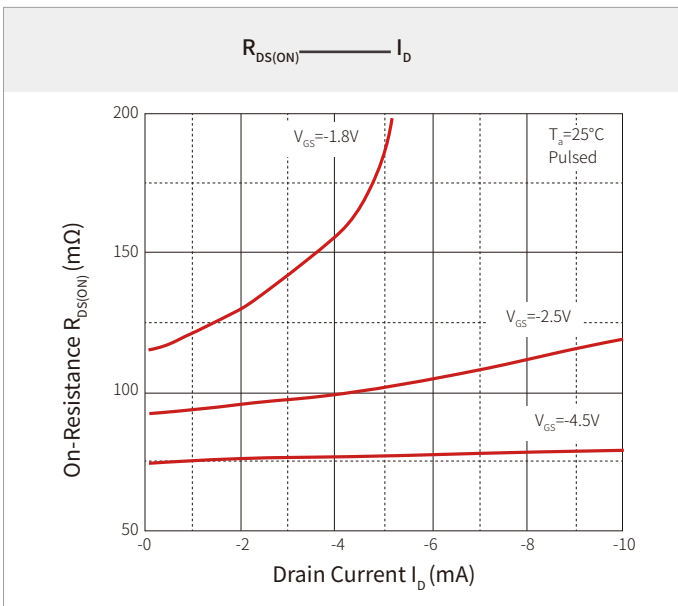
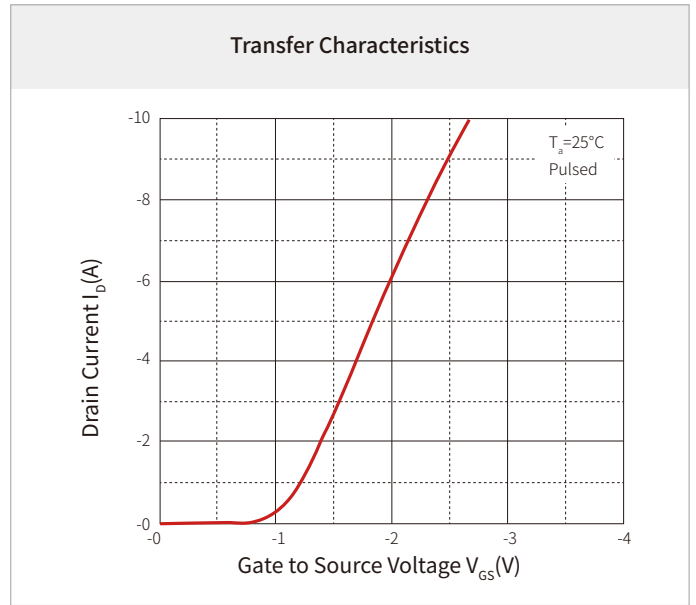
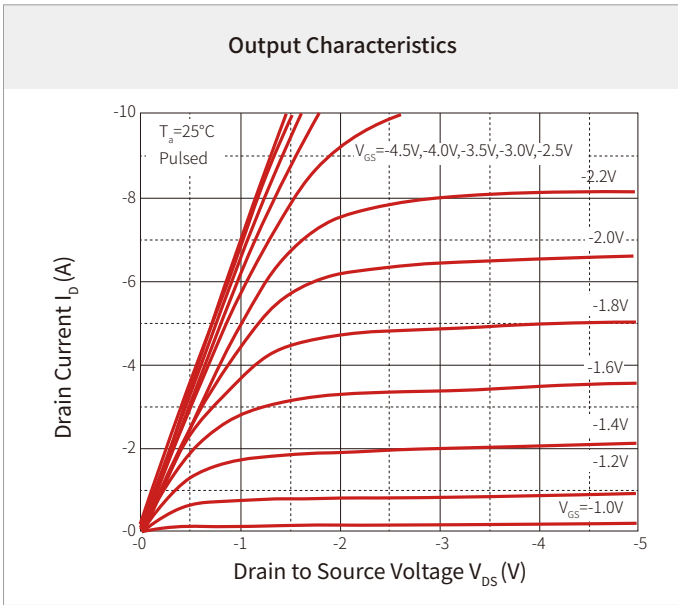

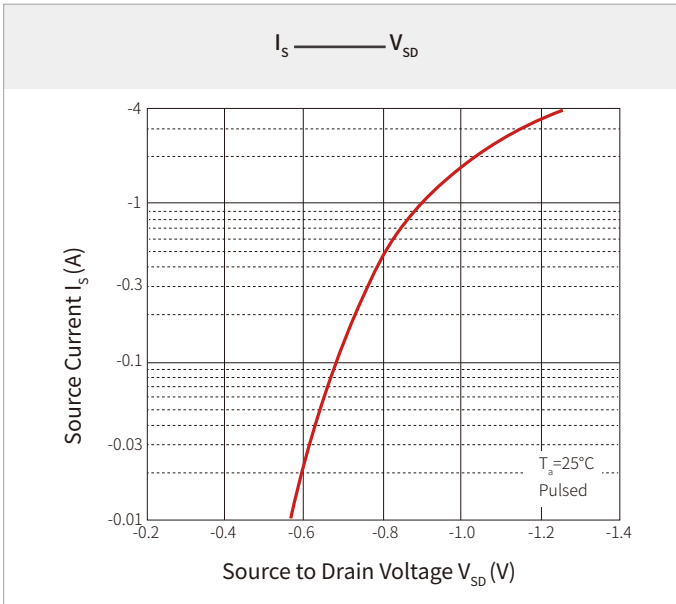

SOLDERING PARAMETERS

Reflow Condition		Lead-free assembly
Pre Heat	Temperature Max ($T_{s(\min)}$)	150°C
	Temperature Max ($T_{s(\max)}$)	200°C
	Time (min to max) (t_s)	60 – 180 secs
Average ramp up rate (Liquidus Temp (T_L) to peak)		3°C/second max
$T_{s(\max)}$ to T_L - Ramp-up Rate		3°C/second max
Reflow	Temperature (T_L) (Liquidus)	217°C
	Time (min to max) (t_L)	60 – 150 seconds
Peak Temperature (T_p)		260°C
Time within 5°C of actual peak Temperature (t_p)		20 – 40 seconds
Ramp-down Rate		6°C/second max
Time 25°C to peak Temperature (T_p)		8 minutes max.
Do not exceed		260°C

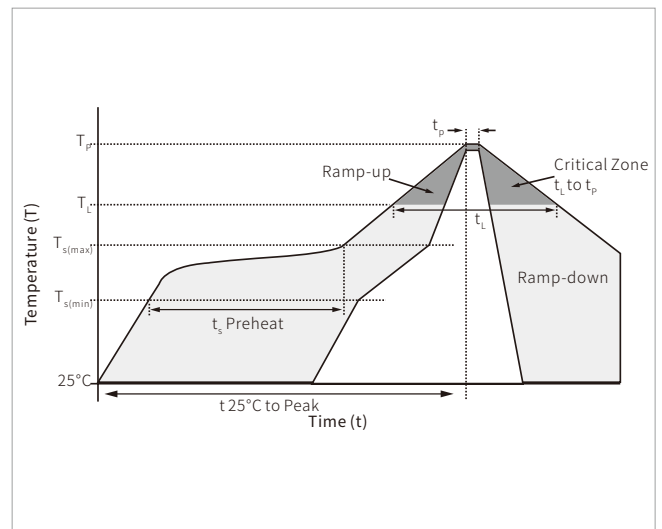

SOT-323 PACKAGE INFORMATION

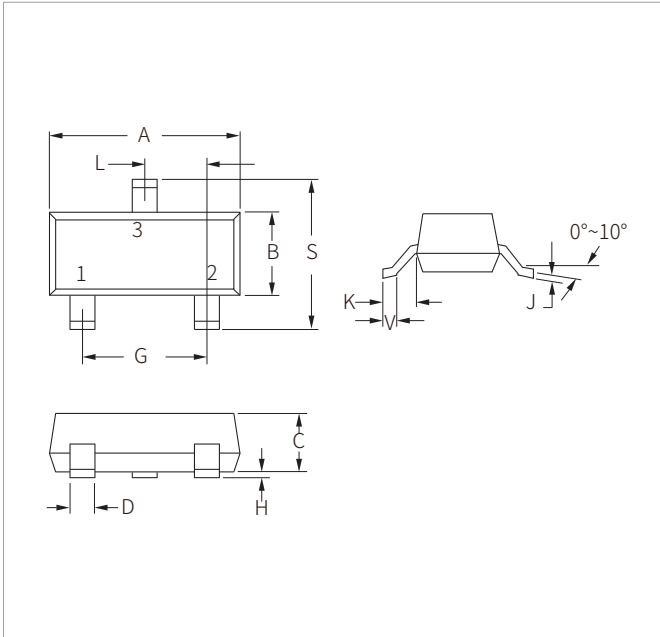

Ref.	Millimeters		Inches	
	Min.	Max.	Min.	Max.
A	2.00	2.20	0.079	0.087
B	1.15	1.35	0.045	0.053
C	0.80	1.10	0.031	0.043
D	0.20	0.40	0.008	0.016
G	1.20	1.40	0.047	0.055
H	0.00	0.10	0.000	0.004
J	0.08	0.15	0.003	0.006
K	0.525REF		0.021REF	
L	0.650TYP		0.026TYP	
S	2.15	2.45	0.085	0.096
V	0.26	0.46	0.010	0.018

RECOMMENDED PAD LAYOUT DIMENSIONS

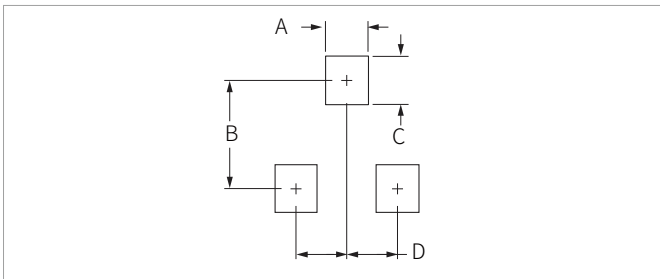

Ref.	Millimeters	Inches
	NOR	NOR
A	0.50	0.020
B	2.20	0.087
C	0.80	0.031
D	1.30	0.051

ORDERING INFORMATION

Part Number	Component Package	QTY/Reel	Reel Size
SPM3139W	SOT-323	3000PCS	7"

Headquarters

No.3387 Shendu Road
Pujiang I&E Park
Minhang Shanghai China
201000

Hotline

400-021-5756

Web

<https://www.semiware.com>

Sales Center

Tel: 86-21-3463-7458
Email: sales18@semiware.com

Customer Service

Tel: 86-21-5484-1001
Email: sales17@semiware.com

Technical Support

Tel: 86-21-3463-7654
Email: fae01@semiware.com

Complaint & Suggestions

Tel: 86-21-3463-7172
Ext: 8868
Email: cs03@semiware.com

By QR Code

Website



Wechat

To find your local partner within Semiware' s global website: www.semiware.com

© 2022 Semiware Semiconductor Inc.

The content of this document has been carefully checked and understood. However, neither Semiware nor its subsidiaries assume any liability whatsoever for any errors or inaccuracies of this document and the consequences thereof. Published specifications are subject to change without notice. Product suitability for any area of application must ultimately be determined by the customer. In all cases, products must never be operated outside their published specifications. Semiware does not guarantee the availability of all published products. This disclaimer shall be governed by substantive Chinese law and resulting disputes shall be settled by the courts at the place of business of Semiware. Latest publications and a complete disclaimer can be downloaded from the Semiware website. All trademarks recognized.