

## FEATURES

- | The plastic package carries Underwriters Laboratory Flammability Classification 94V-0
- | For surface mounted applications
- | Built-in strain relief, ideal for automated placement
- | Low reverse leakage
- | High forward surge current capability
- | High temperature soldering guaranteed 260°C/10 seconds at terminals

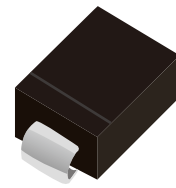

DO-214AA(SMB)

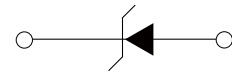

Schematic Symbol

## MECHANICAL DATA

- | Case : Molded plastic body
- | Polarity : Polarity symbol marking on body
- | Mounting Position : Any

## APPROVALS

<b>RoHS</b>	Compliance with 2011/65/EU
<b>HF</b>	Compliance with IEC61249-2-21:2003

## MAXIMUM RATINGS ( $T_A=25^{\circ}\text{C}$ )

Parameter	Symbol	SS22B	SS24B	SS25B	SS26B	SS28B	SS210B	SS215B	SS220B	Unit	
Marking		SS22	SS24	SS25	SS26	SS28	SS210	SS215	SS220		
Maximum repetitive peak reverse voltage	$V_{RRM}$	20	40	50	60	80	100	150	200	V	
Maximum RMS voltage	$V_{RMS}$	14	28	35	42	56	70	105	140	V	
Maximum DC blocking voltage	$V_{DC}$	20	40	50	60	80	100	150	200	V	
Maximum average forward rectified current at $T_L=100^{\circ}\text{C}$	$I_{(AV)}$	2.0								A	
Peak forward surge current, 8.3ms single half sine-wave superimposed on rated load	$I_{FSM}$	50								A	
Maximum instantaneous forward voltage at 2.0A	$V_F$	0.55			0.70	0.85		0.95		V	
Maximum DC reverse current at rated DC blocking voltage	$T_A=25^{\circ}\text{C}$	0.2			0.05					$\mu\text{A}$	
	$T_A=100^{\circ}\text{C}$	10			5					$\mu\text{A}$	
Typical thermal resistance	$R_{\theta JA}$	60								$^{\circ}\text{C}/\text{W}$	
Operating junction temperature range	$T_J$	-55 to +125				-55 to +150					$^{\circ}\text{C}$
Storage temperature range	$T_{STG}$	-55 to +150								$^{\circ}\text{C}$	

# CHARACTERISTIC CURVES

Fig. 1- Derating Curve Output Rectified Current

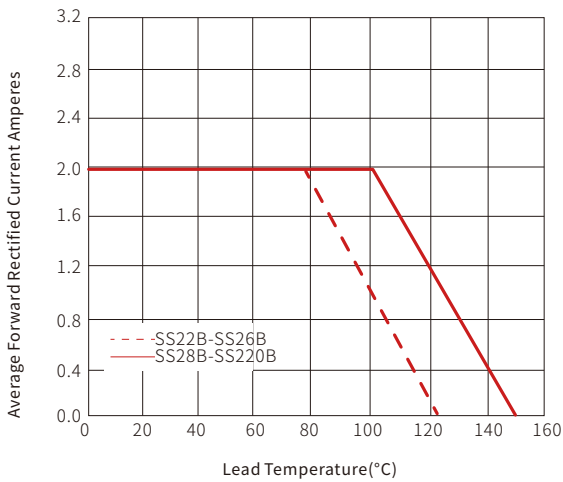

Fig. 2- Maximum Non-repetitive Peak Forward Surge Current Perleg

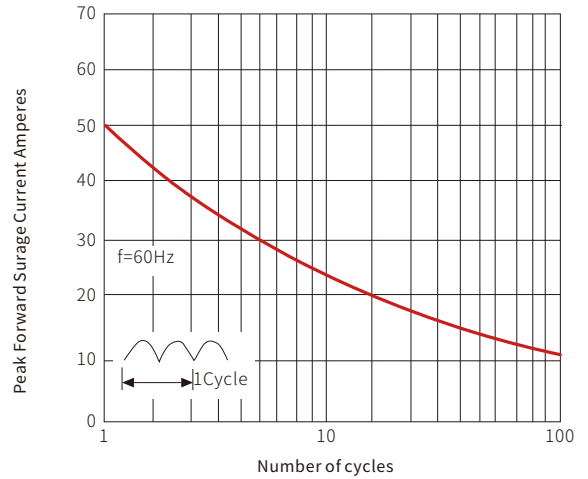

Fig. 3- Typical Forward Voltage Characteristics

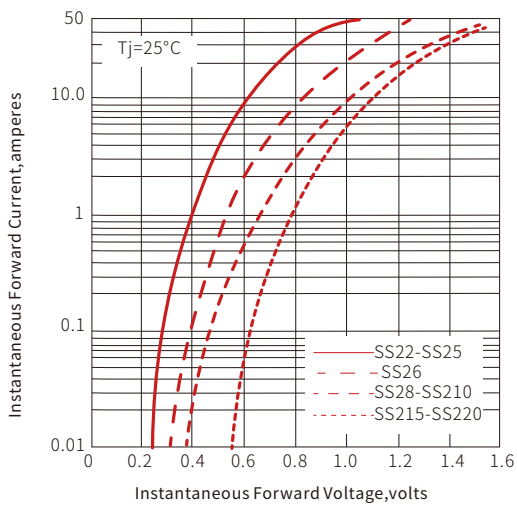
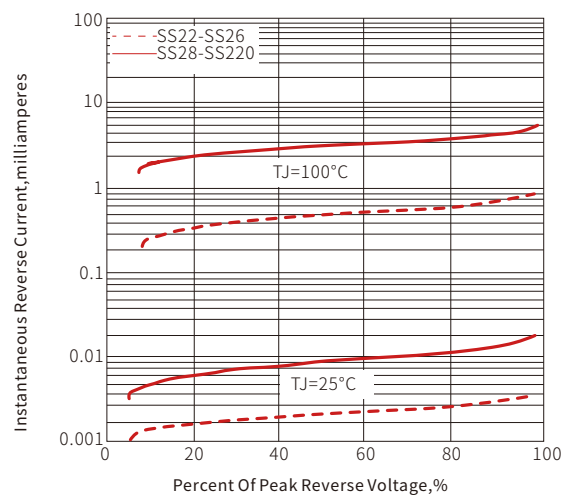
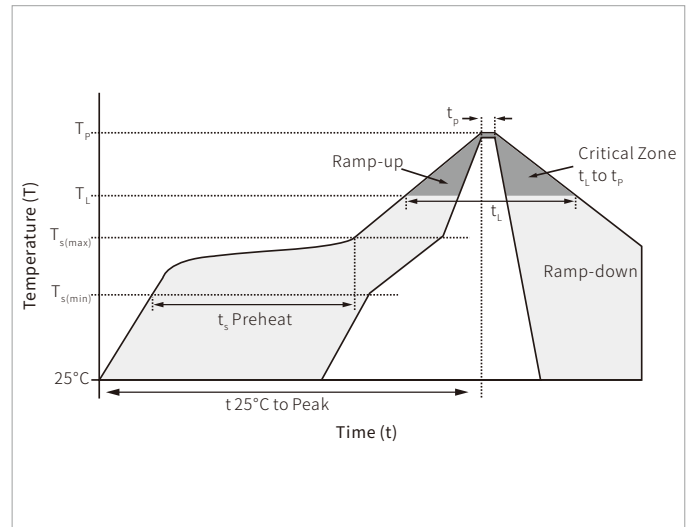

Fig. 4- Typical Reverse Leakage Characteristics



## SOLDERING PARAMETERS

Reflow Condition		Lead-free assembly
Pre Heat	Temperature Max ( $T_{s(min)}$ )	150°C
	Temperature Max ( $T_{s(max)}$ )	200°C
	Time (min to max) ( $t_s$ )	60 – 180 secs
Average ramp up rate (Liquidus Temp ( $T_L$ ) to peak)		3°C/second max
$T_{s(max)}$ to $T_L$ - Ramp-up Rate		3°C/second max
Reflow	Temperature ( $T_L$ ) (Liquidus)	217°C
	Time (min to max) ( $t_l$ )	60 – 150 seconds
Peak Temperature ( $T_p$ )		260°C
Time within 5°C of actual peak Temperature ( $t_p$ )		20 – 40 seconds
Ramp-down Rate		6°C/second max
Time 25°C to peak Temperature ( $T_p$ )		8 minutes max.
Do not exceed		260°C



## DO-214AA(SMB) PACKAGE INFORMATION

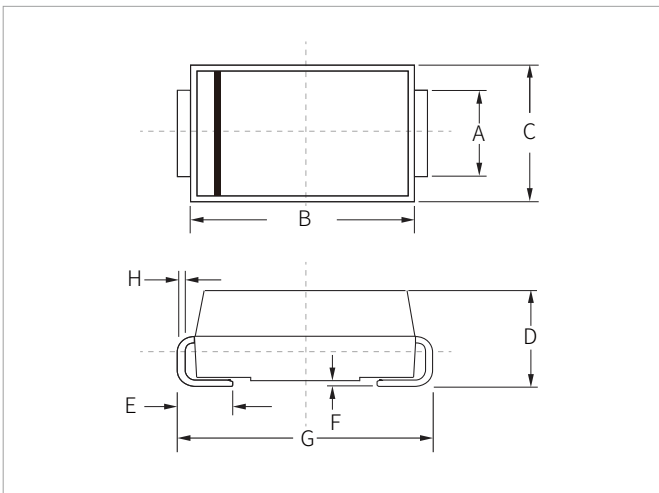

Ref.	Millimeters		Inches	
	Min.	Max.	Min.	Max.
A	1.80	2.20	0.071	0.087
B	4.30	4.70	0.170	0.185
C	3.40	3.90	0.134	0.153
D	2.15	2.75	0.085	0.108
E	1.00	1.50	0.039	0.059
F	0.02	0.20	0.001	0.008
G	5.10	5.50	0.200	0.216
H	0.15	0.30	0.006	0.012

## RECOMMENDED PAD LAYOUT DIMENSIONS

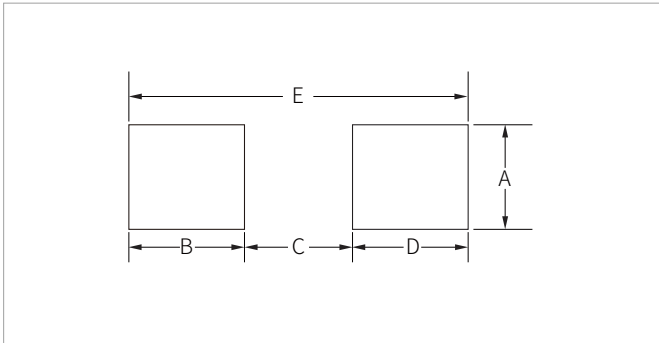

Ref.	Millimeters		Inches	
	Min.	Max.	Min.	Max.
A	2.20	-	0.087	-
B	1.45	-	0.057	-
C	-	2.55	-	0.010
D	1.45	-	0.057	-
E	5.60REF		0.220REF	

## ORDERING INFORMATION

Part Number	Component Package	QTY/Reel	Reel Size
SS22B-SS220B	DO-214AA(SMB)	3000PCS	13"

**Headquarters**

No.3387 Shendu Road  
Pujiang I&E Park  
Minhang Shanghai China  
201000

**Hotline**

400-021-5756

**Web**

<https://www.semiware.com>

**Sales Center**

Tel: 86-21-3463-7458  
Email: [sales18@semiware.com](mailto:sales18@semiware.com)

**Customer Service**

Tel: 86-21-5484-1001  
Email: [sales17@semiware.com](mailto:sales17@semiware.com)

**Technical Support**

Tel: 86-21-3463-7654  
Email: [fae01@semiware.com](mailto:fae01@semiware.com)

**Complaint & Suggestions**

Tel: 86-21-3463-7172  
Ext: 8868  
Email: [cs03@semiware.com](mailto:cs03@semiware.com)

**By QR Code**

Website



Wechat

To find your local partner within Semiware' s global website: [www.semiware.com](http://www.semiware.com)

© 2022 Semiware Semiconductor Inc.

The content of this document has been carefully checked and understood. However, neither Semiware nor its subsidiaries assume any liability whatsoever for any errors or inaccuracies of this document and the consequences thereof. Published specifications are subject to change without notice. Product suitability for any area of application must ultimately be determined by the customer. In all cases, products must never be operated outside their published specifications. Semiware does not guarantee the availability of all published products. This disclaimer shall be governed by substantive Chinese law and resulting disputes shall be settled by the courts at the place of business of Semiware. Latest publications and a complete disclaimer can be downloaded from the Semiware website. All trademarks recognized.