

## FEATURES

- Excellent capability of absorbing transient surge
- Quick response to surge voltage
- Eliminates over voltage caused by fast rising transients
- Solid-state silicon technology, non degenerate

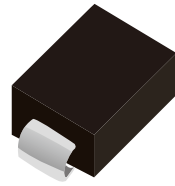

SMB(DO-214AA)



Marking



Schematic Symbol

## APPLICATIONS

- Audio/Video line
- Network and telecom
- Data lines and security systems
- Serial ports

## APPROVALS

<b>RoHS</b>	Compliance with 2011/65/EU
<b>HF</b>	Compliance with IEC61249-2-21:2003

## ELECTRICAL CHARACTERISTICS

Part Number	$V_{DRM}$	$V_S$	$V_T$	$I_{DRM}$	$I_S$	$I_T$	$I_H$	$C_o$
	Min. (V)	Max. (V)	Max. (V)	Max. ( $\mu$ A)	mA	Max. (A)	Min. (mA)	Typ.(pF)
STB80B320	320.0	400.0	4.0	5.0	800.0	2.2	120.0	40.0

## SURGE RATINGS

Part Number	$I_{PP}$ 2x10us	$I_{PP}$ 8x20us	$I_{PP}$ 10x560us	$I_{PP}$ 10x1000us	$V_{PP}$ 10x700us	$I_{TSM}$ 50/60Hz	$d_i/d_t$
	(A)	(A)	(A)	(A)	(V)	(A)	(A/us)
STB80B320	250	250	100	80	4000	25	500

## THERMAL CONSIDERATIONS

Symbol	Parameter	Value	Unit
$R_{\theta JA}$	Junction to Ambient on printed circuit	90	°C/W
$T_J$	Operating Junction Temperature	-55 to +125	°C
$T_{STG}$	Storage Temperature Range	-55 to +150	°C

## RATINGS AND CHARACTERISTIC CURVES ( $T_A=25^\circ\text{C}$ )

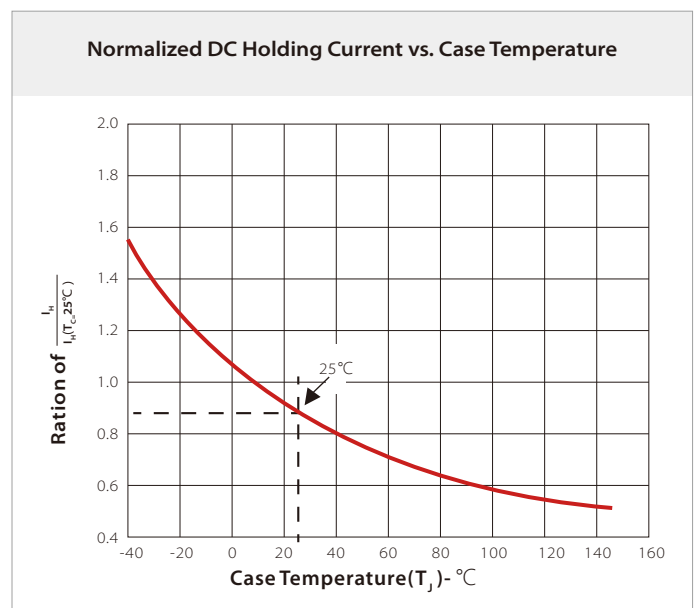
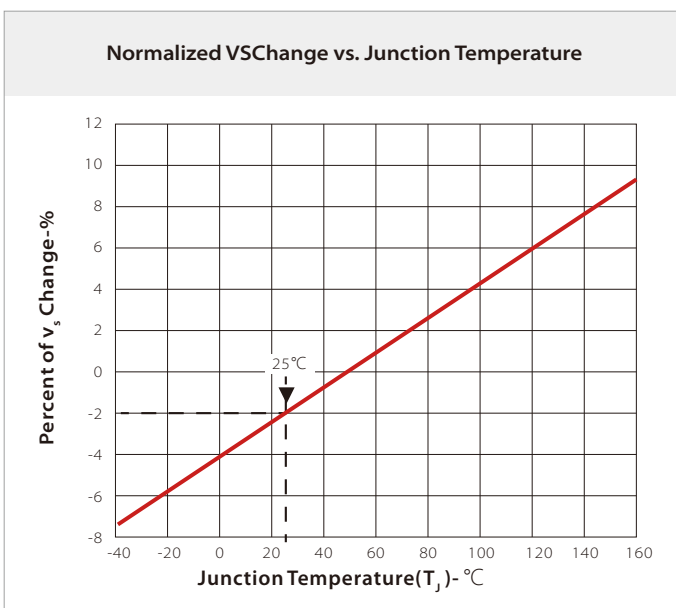
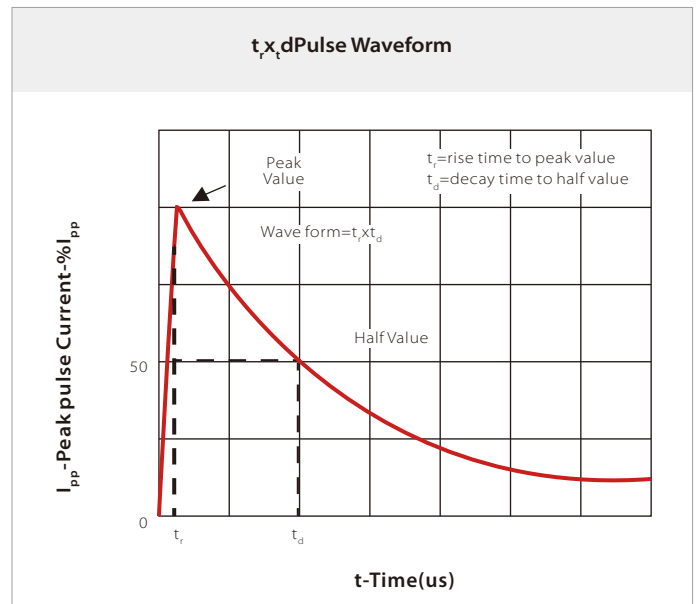
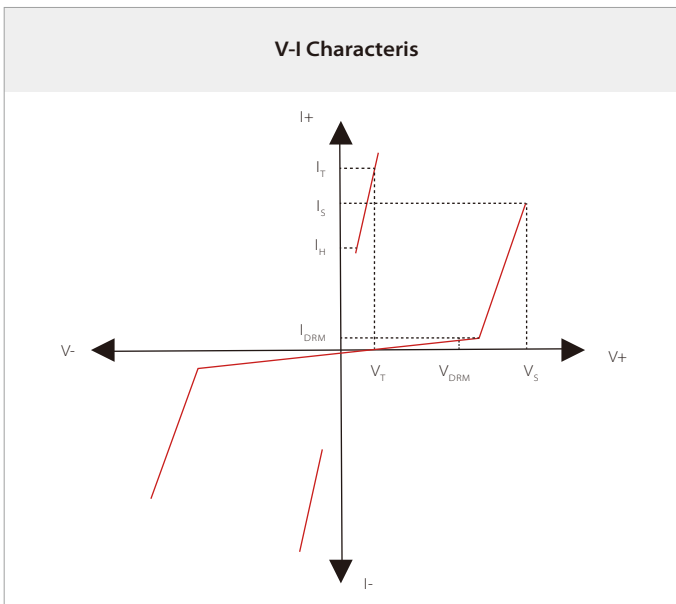

## SOLDERING PARAMETERS

Reflow Condition		Lead-free assembly
Pre Heat	Temperature Max ( $T_{s(min)}$ )	150°C
	Temperature Max ( $T_{s(max)}$ )	200°C
	Time (min to max) ( $t_p$ )	60 – 180 secs
Average ramp up rate (Liquidus Temp ( $T_L$ ) to peak		3°C/second max
$T_{s(max)}$ to $T_L$ - Ramp-up Rate		3°C/second max
Reflow	Temperature ( $T_L$ ) (Liquidus)	217°C
	Time (min to max) ( $t_r$ )	60 – 150 seconds
Peak Temperature ( $T_p$ )		260°C
Time within 5°C of actual peak Temperature ( $t_p$ )		20 – 40 seconds
Ramp-down Rate		6°C/second max
Time 25°C to peak Temperature ( $T_p$ )		8 minutes max.
Do not exceed		260°C

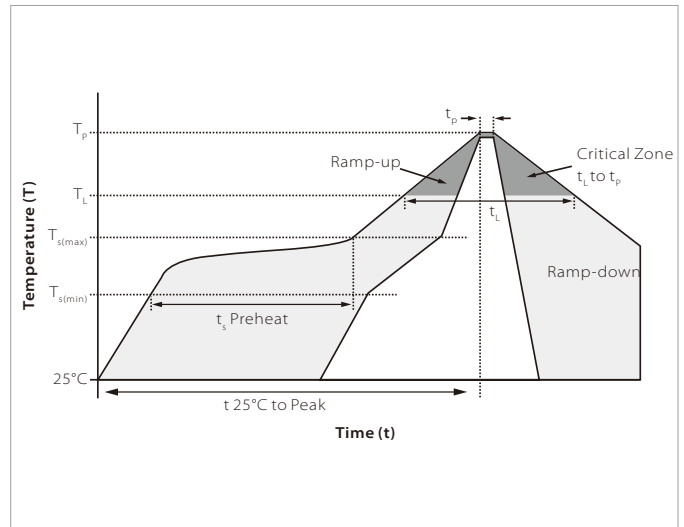

## DO-214AA(SMB) PACKAGE INFORMATION

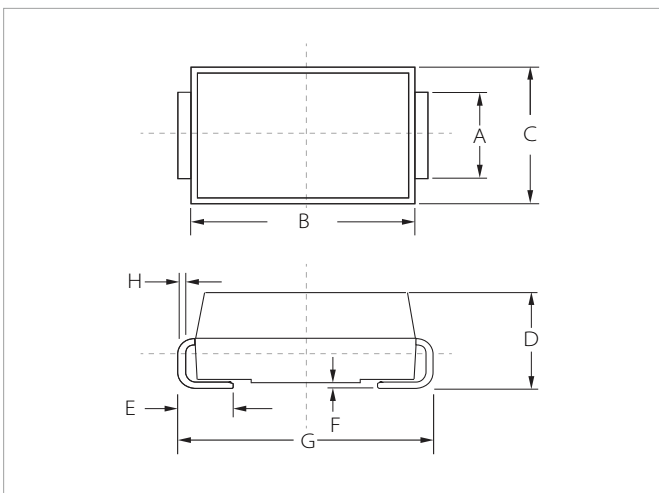

Ref.	Millimeters		Inches	
	Min.	Max.	Min.	Max.
A	1.80	2.20	0.071	0.087
B	4.30	4.70	0.170	0.185
C	3.40	3.90	0.134	0.153
D	2.15	2.55	0.085	0.100
E	1.00	1.50	0.039	0.059
F	0.02	0.20	0.001	0.008
G	5.10	5.50	0.200	0.216
H	0.15	0.30	0.006	0.012

## RECOMMENDED PAD LAYOUT DIMENSIONS

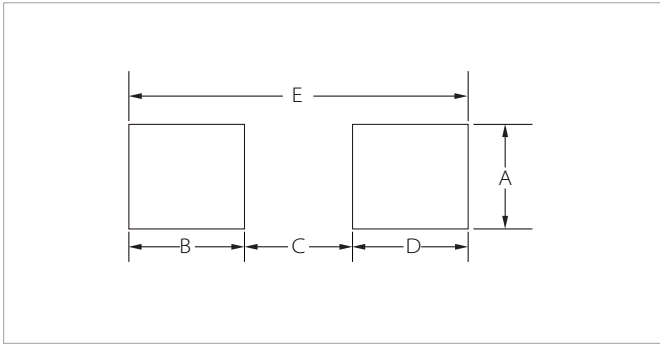

Ref.	Millimeters		Inches	
	Min.	Max.	Min.	Max.
A	2.20	-	0.087	-
B	1.45	-	0.057	-
C	-	2.55	-	0.010
D	1.45	-	0.057	-
E	5.60REF		0.220REF	

## ORDERING INFORMATION

Part Number	Component Package	QTY/Reel	Reel Size
STB80B320	DO-214AA(SMB)	3000PCS	13"

**Headquarters**

No.3387 Shendu Road Pujiang  
I&E Park  
Minhang Shanghai China  
201000

**Hotline**

400-021-5756

**Web**

<https://www.semiware.com>

**Sales Center**

Tel: 86-21-3463-7458  
Email: [sales18@semiware.com](mailto:sales18@semiware.com)

**Customer Service**

Tel: 86-21-5484-1001  
Email: [sales17@semiware.com](mailto:sales17@semiware.com)

**Technical Support**

Tel: 86-21-3463-7654  
Email: [fae01@semiware.com](mailto:fae01@semiware.com)

**Complaint & Suggestions**

Tel: 86-21-3463-7172  
Ext: 8868  
Email: [cs03@semiware.com](mailto:cs03@semiware.com)

**By QR Code**

Website



Wechat

To find your local partner within Semiware's global network: [www.semiware.com](http://www.semiware.com)

© 2022 Semiware Semiconductor Inc.

The content of this document has been carefully checked and understood. However, neither Semiware nor its subsidiaries assume any liability whatsoever for any errors or inaccuracies of this document and the consequences thereof. Published specifications are subject to change without notice. Product suitability for any area of application must ultimately be determined by the customer. In all cases, products must never be operated outside their published specifications. Semiware does not guarantee the availability of all published products. This disclaimer shall be governed by substantive Chinese law and resulting disputes shall be settled by the courts at the place of business of Semiware. Latest publications and a complete disclaimer can be downloaded from the Semiware website. All trademarks recognized.