

## FEATURES

- | Direct interfacing to logic level ICs
- | Direct interfacing to low power gate drive circuits
- | High blocking voltage capability
- | Planar passivated for voltage ruggedness and reliability
- | Triggering in all four quadrant

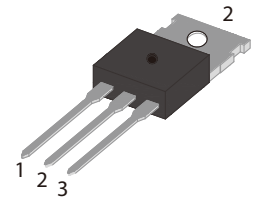

TO-220C

## APPLICATIONS

- | General purpose motor control circuits
- | Phase control operations in light dimmers and motor speed controllers
- | Home appliances

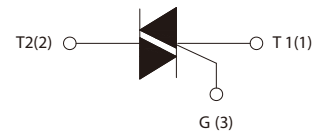

Schematic Symbol

## ABSOLUTE MAXIMUM RATINGS

Parameter	Symbol	Value	Unit
Repetitive peak off-state voltage ( $T_j=25^\circ\text{C}$ )	$V_{\text{DRM}}$	600	V
Repetitive peak reverse voltage ( $T_j=25^\circ\text{C}$ )	$V_{\text{RRM}}$	600	V
RMS on-state current ( $T_c=95^\circ\text{C}$ )	$I_{\text{T(RMS)}}$	8	A
Non repetitive surge peak on-state current (full cycle, F=50Hz)	$I_{\text{TSM}}$	65	
$I^2t$ value for fusing ( $t_p=10\text{ms}$ )	$I^2t$	21	$\text{A}^2\text{S}$
Critical rate of rise of on-state current ( $I_G=2*I_{GT}$ )	I - II - III	50	$\text{A}/\mu\text{s}$
	IV	10	
Peak gate current	$I_{\text{GM}}$	2	A
Average gate power dissipation	$P_{\text{G(AV)}}$	0.5	W
Peak gate power	$P_{\text{GM}}$	5	W
Operating junction temperature range	$T_j$	-40~+125	$^\circ\text{C}$
Storage junction temperature range	$T_{\text{STG}}$	-40~+150	

## ELECTRICAL CHARACTERISTICS ( $T_j=25^\circ\text{C}$ unless otherwise specified)

Symbol	Test Condition	Quadrant	Value				Unit
			D	E	F	G	
$I_{GT}$	$V_D=12\text{V}$	I - II - III	$\leq 5$	$\leq 10$	$\leq 25$	$\leq 50$	mA
		IV	$\leq 10$	$\leq 25$	$\leq 70$	$\leq 100$	
$V_{GT}$		ALL	$\leq 1.3$				V
$V_{GD}$	$V_D=V_{DRM}, R_L=3.3\text{K}\Omega, T_j=125^\circ\text{C}$		$\geq 0.2$				V
$I_H$	$I_T=100\text{mA}$		$\leq 10$	$\leq 15$	$\leq 40$	$\leq 60$	mA
$I_L$	$I_G=1.2I_{GT}$	I - III	$\leq 10$	$\leq 20$	$\leq 50$	$\leq 70$	
		II - IV	$\leq 20$	$\leq 30$	$\leq 70$	$\leq 100$	
$dV_D/dt$	$V_D=67\%V_{DRM}, T_j=125^\circ\text{C}$		$\geq 20$	$\geq 50$	$\geq 50$	$\geq 200$	V/ $\mu\text{s}$
$V_{TM}$	$I_{TM}=10\text{A}, t_p=380\mu\text{s}$		$\leq 1.6$				V
$I_{DRM}$	$V_D=V_{DRM}, V_R=V_{RRM}$	$T_j=25^\circ\text{C}$	$\leq 5$				$\mu\text{A}$
$I_{RRM}$		$T_j=125^\circ\text{C}$	$\leq 1$				mA

## THERMAL RESISTANCES

Symbol	Parameter	Value	Unit
$R_{th(j-c)}$	Junction to case(AC)	1.8	$^\circ\text{C}/\text{W}$

# PARAMETER CHARACTERISTIC CURVE

**FIG.1 Maximum power dissipation versus RMS on-state current**

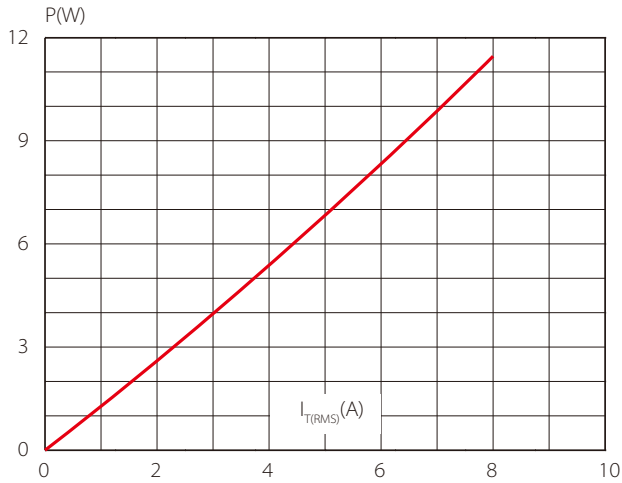

**FIG.2: RMS on-state current versus case temperature**

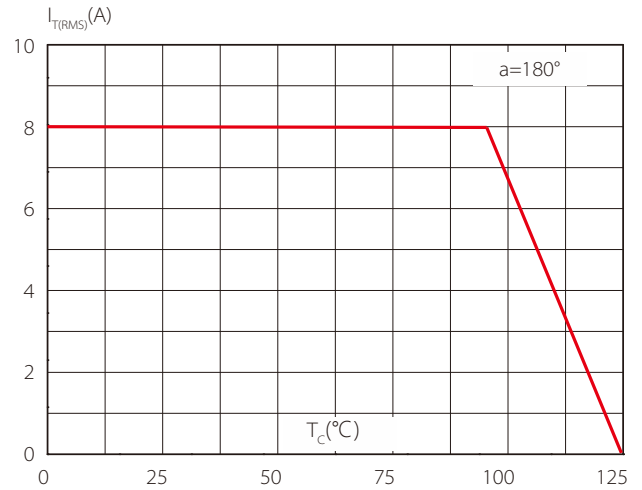

**FIG.3: Surge peak on-state current versus number of cycles**

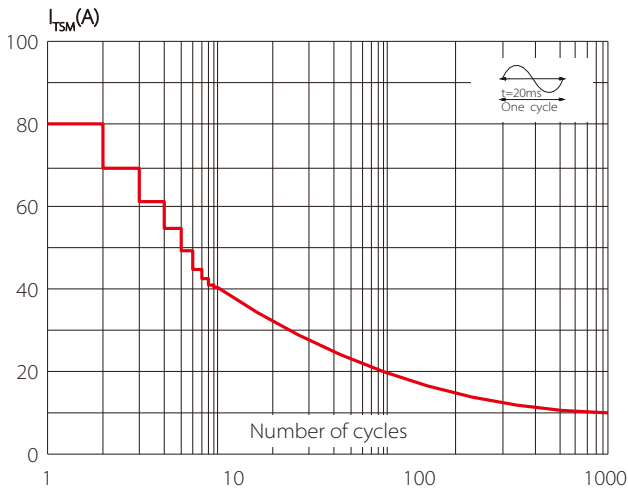

**FIG.4 On-state characteristics (maximum values)**

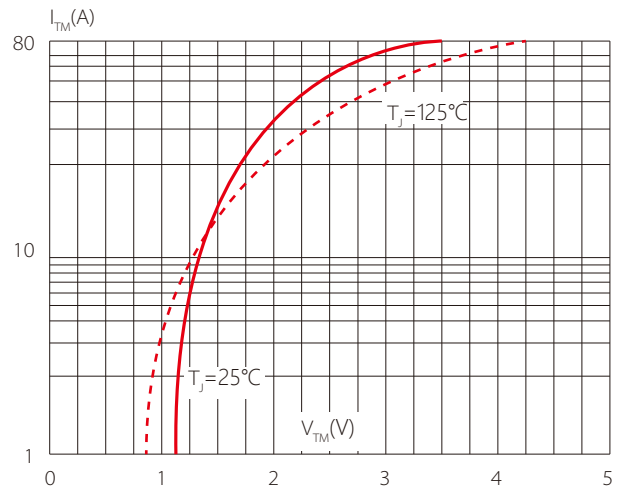

**FIG.5: Non-repetitive surge peak on-state current for a sinusoidal pulse with width  $t_p < 20\text{ms}$  and corresponding value of  $I^2t$  ( $di/dt < 50\text{A}/\mu\text{s}$ )**

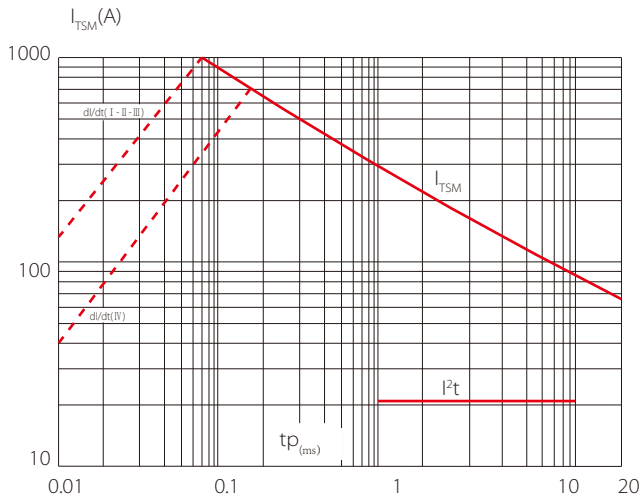

**FIG.6 Relative variations of gate trigger current versus junction temperature**

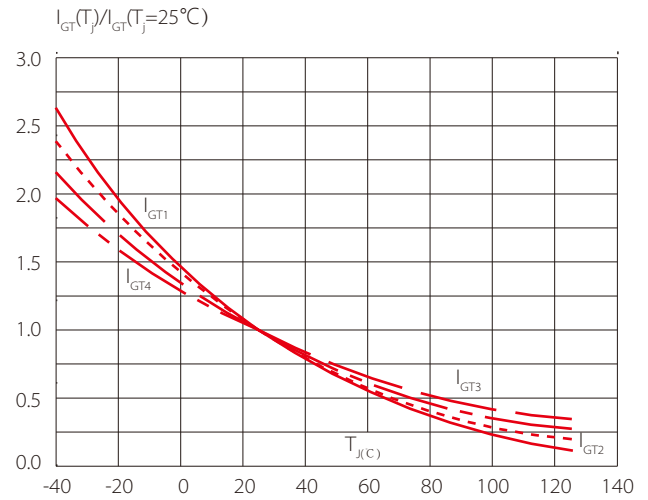

**FIG.7 Relative variations of holding current versus junction temperature**

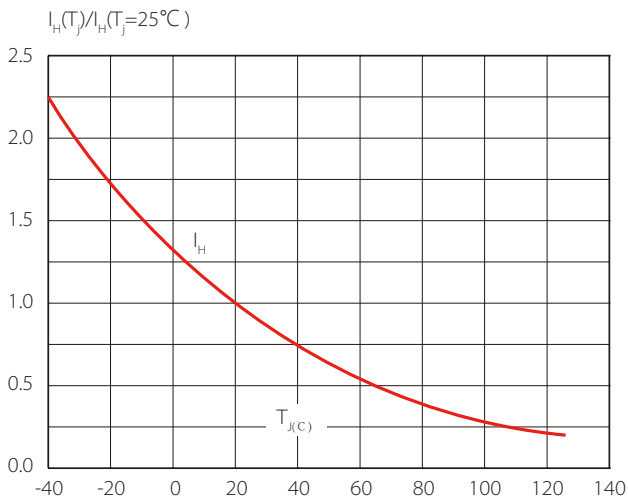

**FIG.8 Relative variations of latching current versus junction temperature**

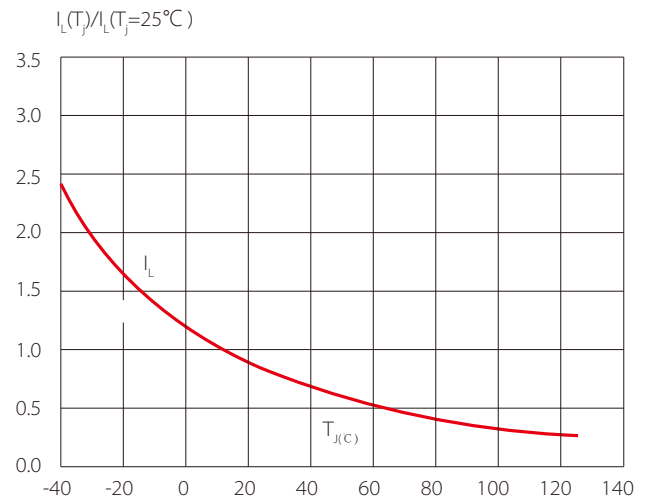

## PACKAGE MECHANICAL DATA

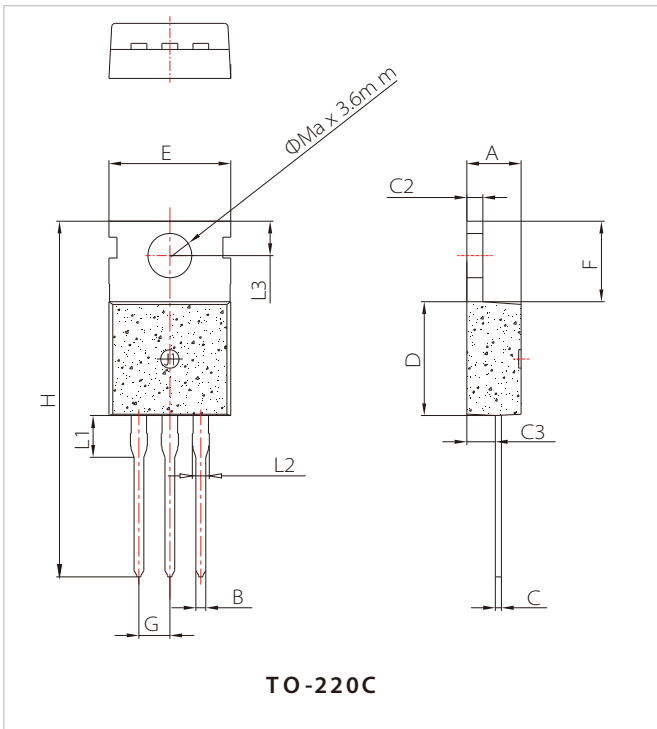

Ref.	Dimensions					
	Ref. Millimeters Inches			Inches		
	Min.	Typ.	Max.	Min.	Typ.	Max.
A	4.40		4.60	0.173		0.181
B	0.70		0.90	0.028		0.035
C	0.45		0.60	0.018		0.024
C2	1.23		1.32	0.048		0.052
C3	2.20		2.60	0.087		0.102
D	8.90		9.90	0.350		0.390
E	9.90		10.3	0.390		0.406
F	6.30		6.90	0.248		0.272
G		2.54			0.1	
H	28.0		29.8	1.102		1.173
L1		3.39			0.133	
L2	1.14		1.70	0.045		0.067
L3	2.65		2.95	0.104		0.116
Φ		3.6			0.142	

## ORDERING INFORMATION

Part Number	Package	Qty/pcs		
		Tube	Inner Box	Carton
STC8Q60D(E/F/G)	TO-220C	50	1000	5000

**Headquarters**

No.3387 Shendu Road Pujiang  
I&E Park  
Minhang Shanghai China  
201000

**Hotline**

400-021-5756

**Web**

<https://www.semiware.com>

**Sales center**

Tel: 86-21-3463-7458  
Email: [sales18@semiware.com](mailto:sales18@semiware.com)

**Customer Service**

Tel: 86-21-5484-1001  
Email: [sales17@semiware.com](mailto:sales17@semiware.com)

**Technical Support**

Tel: 86-21-3463-7654  
Email: [fae01@semiware.com](mailto:fae01@semiware.com)

**Complaint & Suggestions**

Tel: 86-21-3463-7172  
Ext: 8868  
Email: [cs03@semiware.com](mailto:cs03@semiware.com)

**By QR Code**

Website



Wechat

To find your local partner within Semiware's global network: [www.semiware.com](http://www.semiware.com)

© 2022 Semiware Semiconductor Inc.

The content of this document has been carefully checked and understood. However, neither Semiware nor its subsidiaries assume any liability whatsoever for any errors or inaccuracies of this document and the consequences thereof. Published specifications are subject to change without notice. Product suitability for any area of application must ultimately be determined by the customer. In all cases, products must never be operated outside their published specifications. Semiware does not guarantee the availability of all published products. This disclaimer shall be governed by substantive Swiss law and resulting disputes shall be settled by the courts at the place of business of Semiware. Latest publications and a complete disclaimer can be downloaded from the Semiware website. All trademarks recognized.