

FEATURES

- | High current 16 A RMS current Triac
- | Low thermal resistance
- | High commutation or very high commutation capability
- | RoHS (2002/95/EC) compliant packages
- | UL-94, V0 flammability package resin compliance

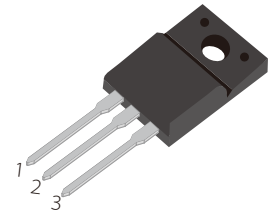

TO-220F

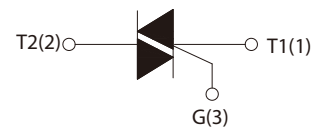

Schematic Symbol

APPLICATIONS

- | General purpose motor control circuits
- | Phase control operations in light dimmers and motor speed controllers
- | Home appliances

APPROVALS

| | |
|-------------|------------------------------------|
| RoHS | Compliance with 2011/65/EU |
| HF | Compliance with IEC61249-2-21:2003 |

THE MAIN PARAMETERS

| Symbol | Parameter | Value | Unit |
|--------------|-----------------------------------|-------|------|
| $I_{T(RMS)}$ | RMS on-state current | 16 | A |
| V_{DRM} | Off-state repetitive peak voltage | 600 | V |
| V_{TM} | On-state voltage | 1.5 | V |

ABSOLUTE MAXIMUM RATINGS

| Parameter | Symbol | Value | Unit |
|---|---------------------|----------|------------------|
| Repetitive peak off-state voltage ($T_j=25^\circ\text{C}$) | V_{DRM} | 600 | V |
| Repetitive peak reverse voltage ($T_j=25^\circ\text{C}$) | V_{RRM} | 600 | V |
| RMS on-state current ($T_c=90^\circ\text{C}$) | $I_{\text{T(RMS)}}$ | 16 | A |
| Non repetitive surge peak on-state current (full cycle, $F=50\text{Hz}$) | I_{TSM} | 160 | |
| I ² t value for fusing ($t_p=10\text{ms}$) | I ² t | 128 | A ² S |
| Critical rate of rise of on-state current ($I_G=2 \cdot I_{\text{GT}}$) | d/d_t | 50 | A/ μs |
| Peak gate current | I_{GM} | 4 | A |
| Average gate power dissipation | $P_{\text{G(AV)}}$ | 1 | W |
| Storage junction temperature range | T_{STG} | -40~+150 | °C |
| Operating junction temperature range | T_j | -40~+125 | |

ELECTRICAL CHARACTERISTICS ($T_j=25^\circ\text{C}$ unless otherwise specified)

| Symbol | Test Condition | Quadrant | Value | | | | Unit |
|------------------|--|-------------------------|------------|------------|------------|-------------|------------------|
| | | | TW | SW | CW | BW | |
| I_{GT} | $V_D=12\text{V}, R_L=33\Omega$ | I - II - III | ≤ 5 | ≤ 10 | ≤ 35 | ≤ 50 | mA |
| V_{GT} | | | ≤ 1.3 | | | | |
| V_{GD} | $V_D=V_{\text{DRM}}, R_L=3.3\text{K}\Omega, T_j=125^\circ\text{C}$ | | ≥ 0.2 | | | | V |
| I_{H} | $I_t=100\text{mA}$ | | ≤ 15 | ≤ 25 | ≤ 40 | ≤ 60 | mA |
| I_{L} | $I_G=1.2I_{\text{GT}}$ | I - III | ≤ 15 | ≤ 30 | ≤ 50 | ≤ 70 | |
| | | II | ≤ 20 | ≤ 40 | ≤ 60 | ≤ 80 | |
| dV_D/dt | $V_D=67\%V_{\text{DRM}}, T_j=125^\circ\text{C}$ | | ≥ 100 | ≥ 200 | ≥ 500 | ≥ 1000 | V/ μs |
| V_{TM} | $I_{\text{TM}}=22.5\text{A}, t_p=380\mu\text{s}$ | | ≤ 1.5 | | | | V |
| I_{DRM} | $V_D=V_{\text{DRM}}, V_R=V_{\text{RRM}}$ | $T_j=25^\circ\text{C}$ | ≤ 5 | | | | μA |
| I_{RRM} | | $T_j=125^\circ\text{C}$ | ≤ 1 | | | | mA |

THERMAL RESISTANCES

| Symbol | Parameter | Value | Unit |
|---------------|----------------------|-------|------|
| $R_{th(j-c)}$ | Junction to case(AC) | 2.3 | °C/W |

PARAMETER CHARACTERISTIC CURVE

FIG.1 Maximum power dissipation versus RMS on-state current

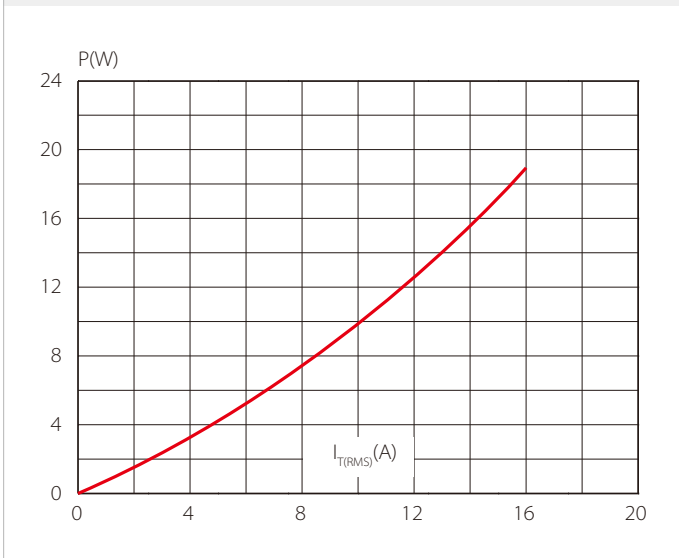

FIG.2: RMS on-state current versus case temperature

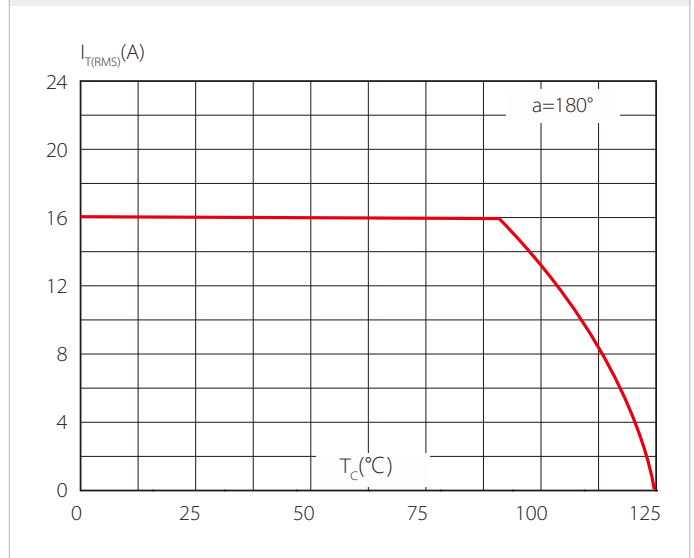

FIG.3: Surge peak on-state current versus number of cycles

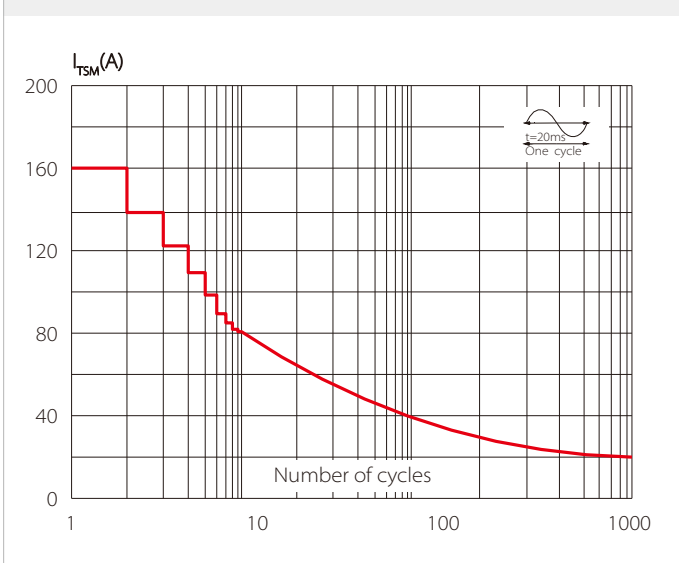

FIG.4 On-state characteristics (maximum values)

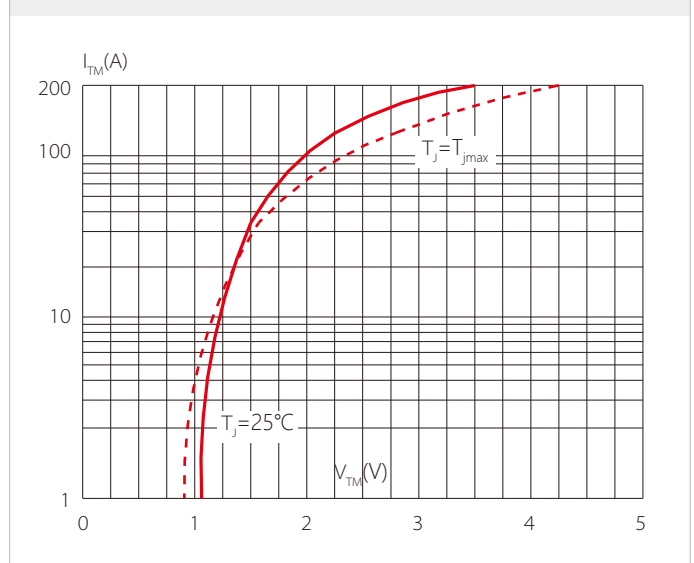

FIG.5: Non-repetitive surge peak on-state current for a sinusoidal pulse with width $t_p < 20\text{ms}$ and corresponding value of I^2t ($dI/dt < 50\text{A}/\mu\text{s}$)

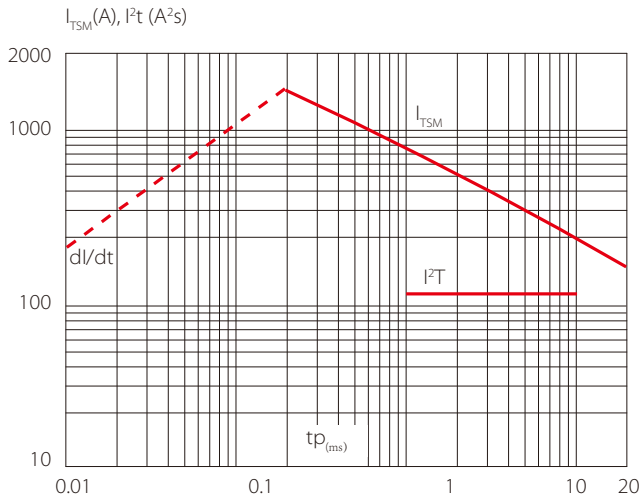

FIG.6 Relative variations of gate trigger current versus junction temperature

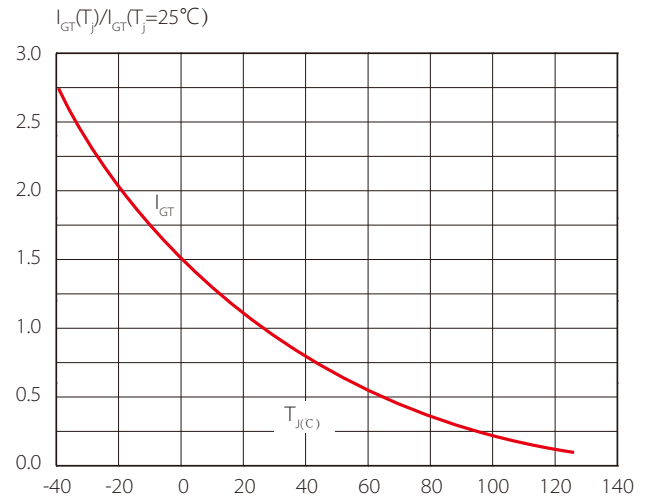

FIG.7 Relative variations of holding current versus junction temperature

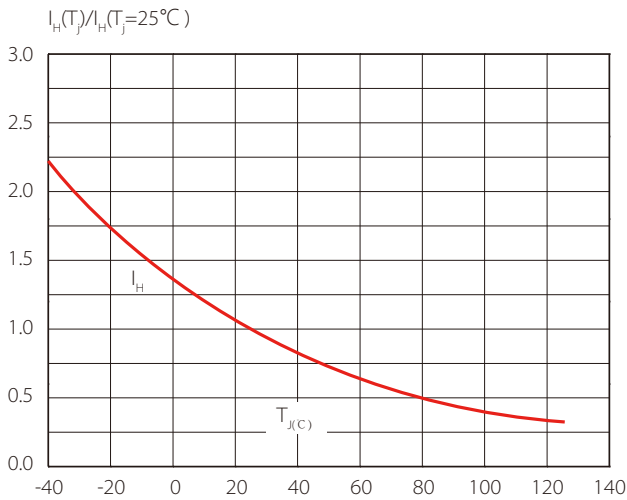
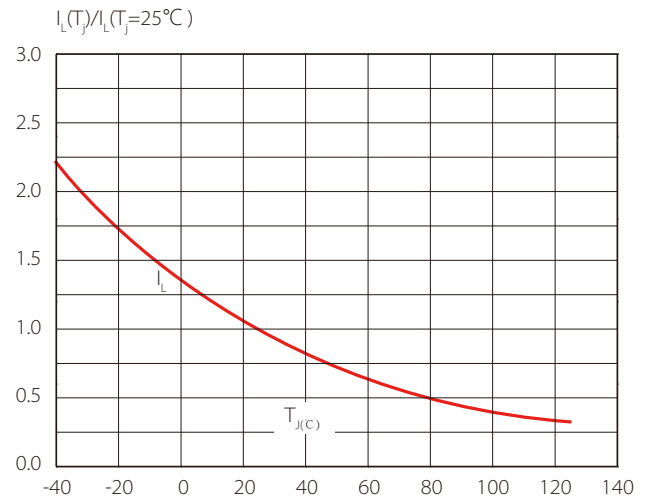
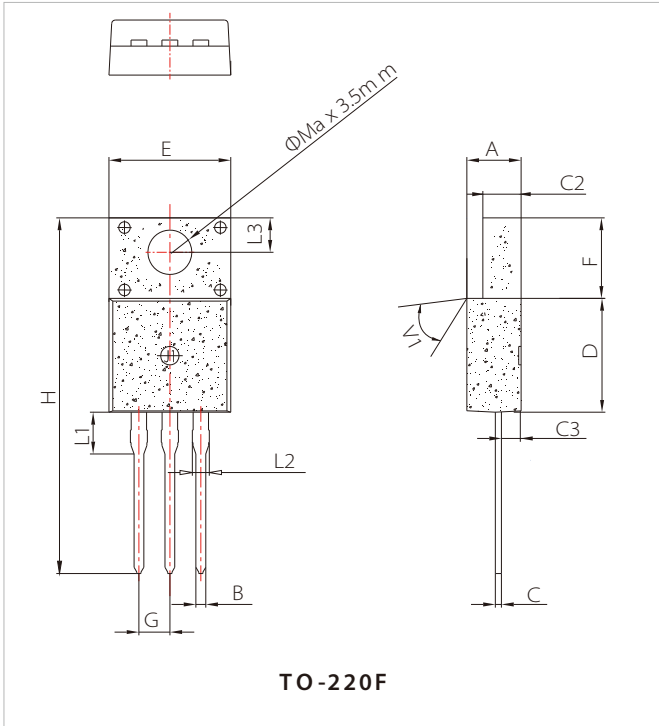

FIG.8 Relative variations of latching current versus junction temperature



PACKAGE MECHANICAL DATA



| Ref. | Dimensions | | | | | |
|------|------------------|------|------|--------|-------|-------|
| | Ref. Millimeters | | | Inches | | |
| | Min. | Typ. | Max. | Min. | Typ. | Max. |
| A | 4.40 | | 4.80 | 0.173 | | 0.181 |
| B | 0.74 | 0.80 | 0.83 | 0.029 | | 0.033 |
| C | 0.48 | | 0.75 | 0.019 | | 0.030 |
| C2 | 2.40 | | 2.70 | 0.094 | | 0.106 |
| C3 | 2.60 | | 3.00 | 0.102 | | 0.118 |
| D | 8.80 | | 9.30 | 0.346 | | 0.366 |
| E | 9.70 | | 10.3 | 0.382 | | 0.406 |
| F | 6.40 | | 7.00 | 0.252 | | 0.276 |
| G | | 2.54 | | | 0.1 | |
| H | 28.0 | | 29.8 | 1.102 | | 1.173 |
| L1 | | 3.63 | | | 0.143 | |
| L2 | 1.14 | | 1.70 | 0.045 | | 0.067 |
| L3 | | 3.30 | | | 0.130 | |
| V1 | | 45° | | | 45° | |

ORDERING INFORMATION

| Part Number | Package | Qty/pcs | | |
|----------------------|---------|---------|-----------|--------|
| | | Tube | Inner Box | Carton |
| STF16A60TW(SW/CW/BW) | TO-220F | 50 | 1000 | 5000 |

Headquarters

No.3387 Shendu Road Pujiang
I&E Park
Minhang Shanghai China
201000

Hotline

400-021-5756

Web

<https://www.semiware.com>

Sales center

Tel: 86-21-3463-7458
Email: sales18@semiware.com

Customer Service

Tel: 86-21-5484-1001
Email: sales17@semiware.com

Technical Support

Tel: 86-21-3463-7654
Email: fae01@semiware.com

Complaint & Suggestions

Tel: 86-21-3463-7172
Ext: 8868
Email: cs03@semiware.com

By QR Code

Website



Wechat

To find your local partner within Semiware's global network: www.semiware.com

© 2022 Semiware Semiconductor Inc.

The content of this document has been carefully checked and understood. However, neither Semiware nor its subsidiaries assume any liability whatsoever for any errors or inaccuracies of this document and the consequences thereof. Published specifications are subject to change without notice. Product suitability for any area of application must ultimately be determined by the customer. In all cases, products must never be operated outside their published specifications. Semiware does not guarantee the availability of all published products. This disclaimer shall be governed by substantive Swiss law and resulting disputes shall be settled by the courts at the place of business of Semiware. Latest publications and a complete disclaimer can be downloaded from the Semiware website. All trademarks recognized.