

## FEATURES

- | Low profile package
- | Ideal for automated placement
- | 5000 Watt peak pulse power capability with a 10/1000 $\mu$ s waveform
- | For surface mounted applications to optimize board space
- | Excellent clamping capability
- | Very fast response time
- | Low incremental surge resistance

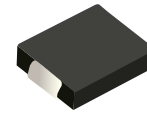

DO-214AB(SMC)

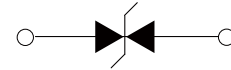

Schematic Symbol

## APPLICATIONS

- | Power supply protection
- | Automotive application
- | Industrial application
- | Power management

## APPROVALS

<b>RoHS</b>	Compliance with 2011/65/EU
<b>HF</b>	Compliance with IEC61249-2-21:2003

## MAXIMUM RATINGS ( $T_A=25^\circ\text{C}$ )

Parameter	Symbol	Value	Unit
Peak Pulse Power Dissipation on 10/1000 $\mu$ s waveform (Note1, Note2).	$P_{PPM}$	5000	Watts
Steady State Power Dissipation at $T_L=50^\circ\text{C}$ , Lead lengths.375"(9.5mm) ( Note2)	$P_D$	6.5	Watts

- Notes :** 1.Non-repetitive current pulse, $T_A=25^\circ\text{C}$ .  
 2.Mounted on 5.0mm\*5.0mm (0.03mm thick) Copper Pads to each terminal.

## THERMAL CONSIDERATIONS

Parameter	Symbol	Value	Unit
Operating Junction Temperature	$T_J$	-55 to +150	$^\circ\text{C}$
Storage Temperature Range	$T_{STG}$	-55 to +150	$^\circ\text{C}$
Junction to Ambient on printed circuit	$R_{\theta JA}$	75	$^\circ\text{C}/\text{W}$

## ELECTRICAL CHARACTERISTICS (T<sub>A</sub>=25°C)

Part Number	Device Marking Code	Reverse Stand-off Voltage	Breakdown Voltage Min.@I <sub>T</sub>	Breakdown Voltage Max.@I <sub>T</sub>	Test Current	Maximum Clamping Voltage @I <sub>pp</sub>	Peak Pulse Current	Reverse Leakage @V <sub>RWM</sub>
		V <sub>RWM</sub> (V)	V <sub>BR</sub> (V)	V <sub>BR</sub> (V)	I <sub>T</sub> (mA)	V <sub>C</sub> (V)	I <sub>pp</sub> (A)	I <sub>R</sub> (uA)
SVC500B5.0	5BDE	5.0	6.4	7.25	50	9.2	554.3	5000

## CHARACTERISTIC CURVES

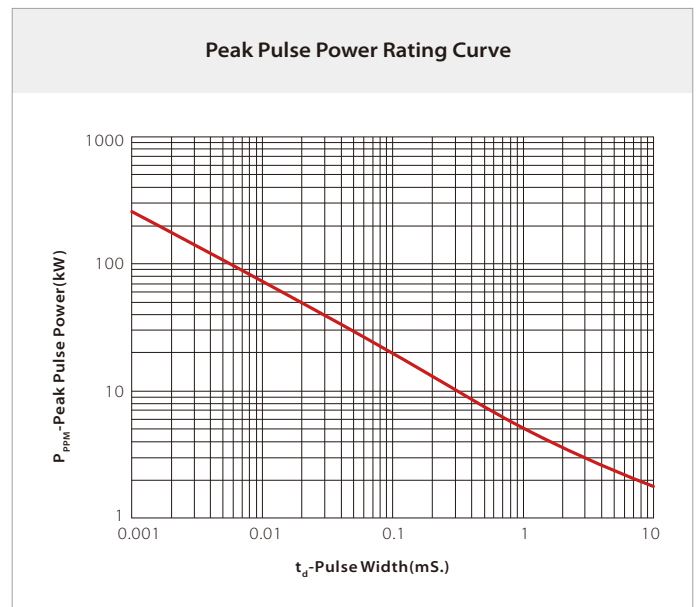
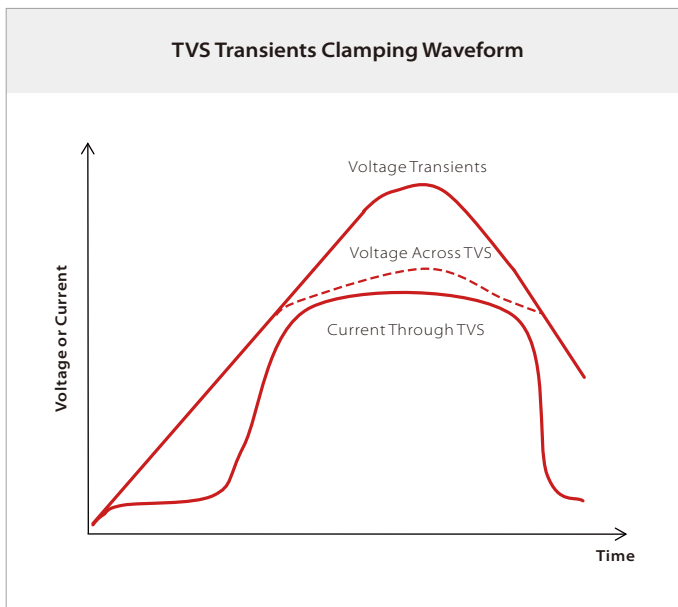

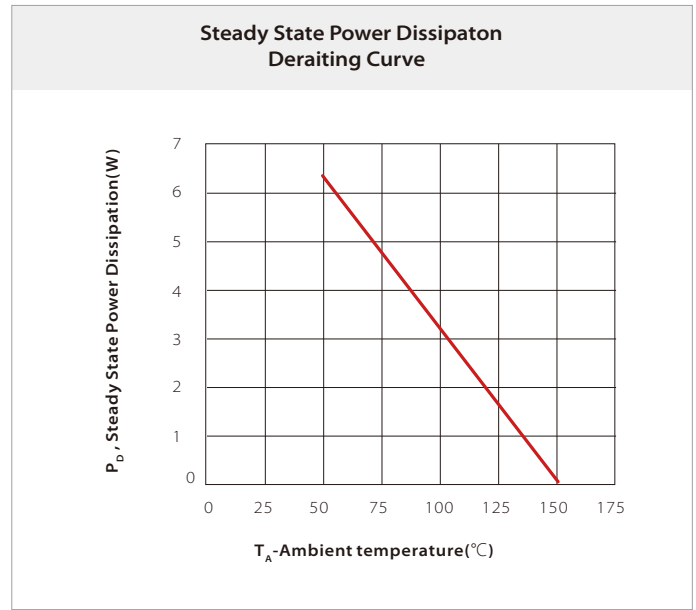
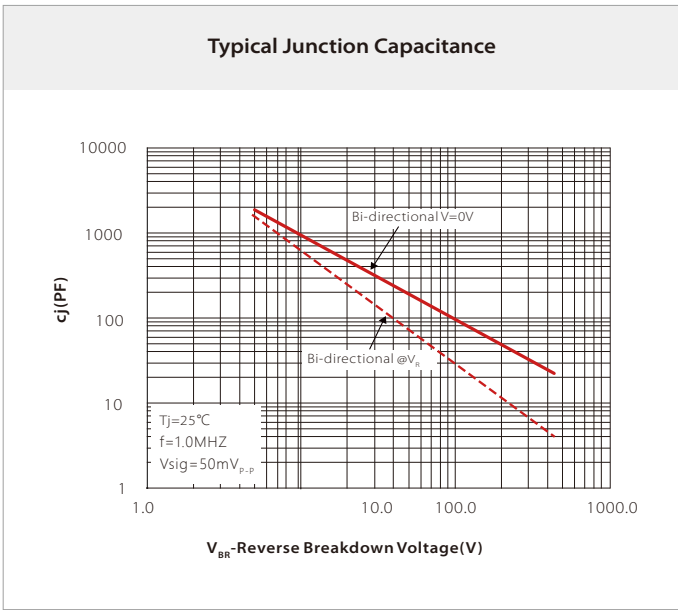

## SOLDERING PARAMETERS

Reflow Condition		Lead-free assembly
Pre Heat	Temperature Max ( $T_{s(min)}$ )	150 $^\circ\text{C}$
	Temperature Max ( $T_{s(max)}$ )	200 $^\circ\text{C}$
	Time (min to max) ( $t_2$ )	60 – 180 secs
Average ramp up rate (Liquidus Temp ( $T_L$ ) to peak)		3 $^\circ\text{C}/\text{second}$ max
$T_{s(max)}$ to $T_L$ - Ramp-up Rate		3 $^\circ\text{C}/\text{second}$ max
Reflow	Temperature ( $T_L$ ) (Liquidus)	217 $^\circ\text{C}$
	Time (min to max) ( $t_1$ )	60 – 150 seconds
Peak Temperature ( $T_p$ )		260 $^\circ\text{C}$
Time within 5 $^\circ\text{C}$ of actual peak Temperature ( $t_p$ )		20 – 40 seconds
Ramp-down Rate		6 $^\circ\text{C}/\text{second}$ max
Time 25 $^\circ\text{C}$ to peak Temperature ( $T_p$ )		8 minutes max.
Do not exceed		260 $^\circ\text{C}$

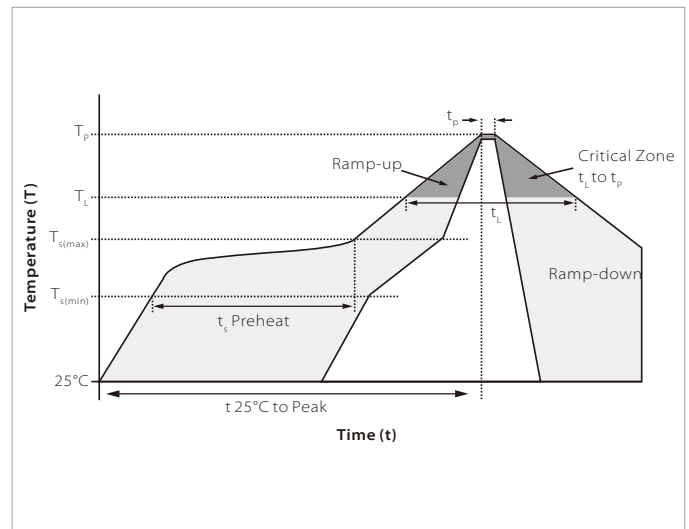

## DO-214AB(SMC) PACKAGE INFORMATION

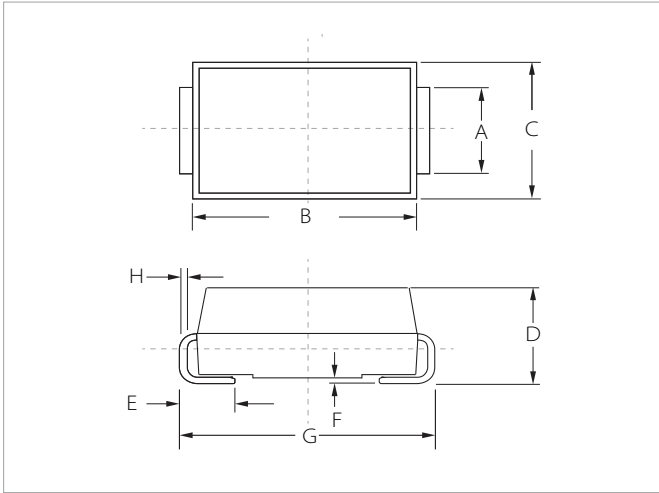

Ref.	Millimeters		Inches	
	Min.	Max.	Min.	Max.
A	2.80	3.20	0.110	0.126
B	6.60	7.20	0.260	0.283
C	5.70	6.10	0.224	0.240
D	2.15	2.75	0.085	0.108
E	1.00	1.60	0.039	0.063
F	0.02	0.20	0.000	0.008
G	7.60	8.00	0.299	0.315
H	0.15	0.30	0.006	0.012

## RECOMMENDED PAD LAYOUT DIMENSIONS

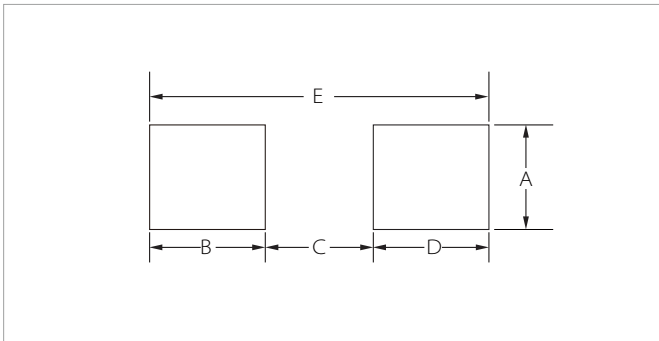

Ref.	Millimeters		Inches	
	Min.	Max.	Min.	Max.
A	3.30	-	0.129	-
B	2.40	-	0.094	-
C	-	4.20	-	0.165
D	2.40	-	0.094	-
E	8.20REF		0.323REF	

## ORDERING INFORMATION

Part Number	Component Package	QTY/Reel	Reel Size
SVC500B5.0	DO-214AB(SMC)	3000PCS	13"

**Headquarters**

No.3387 Shendu Road Pujiang  
I&E Park  
Minhang Shanghai China  
201000

**Hotline**

400-021-5756

**Web**

<https://www.semiware.com>

**Sales Center**

Tel: 86-21-3463-7458  
Email: [sales18@semiware.com](mailto:sales18@semiware.com)

**Customer Service**

Tel: 86-21-5484-1001  
Email: [sales17@semiware.com](mailto:sales17@semiware.com)

**Technical Support**

Tel: 86-21-3463-7654  
Email: [fae01@semiware.com](mailto:fae01@semiware.com)

**Complaint & Suggestions**

Tel: 86-21-3463-7172  
Ext: 8868  
Email: [cs03@semiware.com](mailto:cs03@semiware.com)

**By QR Code**

Website



Wechat

To find your local partner within Semiware's global network: [www.semiware.com](http://www.semiware.com)

© 2022 Semiware Semiconductor Inc.

The content of this document has been carefully checked and understood. However, neither Semiware nor its subsidiaries assume any liability whatsoever for any errors or inaccuracies of this document and the consequences thereof. Published specifications are subject to change without notice. Product suitability for any area of application must ultimately be determined by the customer. In all cases, products must never be operated outside their published specifications. Semiware does not guarantee the availability of all published products. This disclaimer shall be governed by substantive Chinese law and resulting disputes shall be settled by the courts at the place of business of Semiware. Latest publications and a complete disclaimer can be downloaded from the Semiware website. All trademarks recognized.