

FEATURES

- | Ideal For Automated Placement
- | Glass passivated chip junction
- | High Forward Surge Capability
- | Meet AEC-Q101 Requirements



DO-214AC(SMA)



Schematic Symbol

APPLICATIONS

- | For Use In General Purpose Rectification Of Power Supplies, Inverters, Converters, And Freewheeling Diodes For Consumer, And Telecommunication

APPROVALS

RoHS	Compliance with 2011/65/EU
HF	Compliance with IEC61249-2-21:2003

MAXIMUM RATINGS AND CHARACTERISTICS (T_A=25°C)

Parameter	Symbol	US 1AQ	US 1BQ	US 1DQ	US 1FQ	US 1GQ	US 1JQ	US 1KQ	US 1MQ	Unit
		US 1AQ	US 1BQ	US 1DQ	US 1FQ	US 1GQ	US 1JQ	US 1KQ	US 1MQ	
Marking		US 1AQ	US 1BQ	US 1DQ	US 1FQ	US 1GQ	US 1JQ	US 1KQ	US 1MQ	
Maximum Repetitive peak reverse voltage	V _{RRM}	50	100	200	300	400	600	800	1000	V
Maximum RMS Voltage	V _{RMS}	35	70	140	210	280	420	560	700	
Maximum DC Blocking Voltage	V _{DC}	50	100	200	300	400	600	800	1000	
Average rectified output current @60Hz sine wave, Resistance load, TL (FIG.1)	I _o	1.0								A
Forward Surge Current (Non-Repetitive) @60Hz Half-sine Wave, 1 cycle, T _J =25°C	I _{FSM}	30								
Forward Surge Current (Non-Repetitive) @1ms, square Wave, 1 cycle, T _J =25°C		60								
Maximum Instantaneous Forward Voltage I _{FM} =1.0A	V _F	1.0		1.3		1.7			V	
Maximum DC Reverse Current at Rated DC Blocking Voltage	I _R	5								μA
		100								
Typical Junction Capacitance Measured at 1MHz and Applied Reverse Voltage Of 4.0 V.D.C	C _J	15		10		7			pF	
Maximum reverse recovery time I _F =0.5A, I _R =1.0A, I _{rr} =0.25A	t _{rr}	50					75			ns
Current squared time @1ms ≤ t ≤ 8.3ms T _J =25°C	I ² t	3.735								A ² s
Typical Thermal Resistance ⁽¹⁾	R _{θJ-A}	70								°C/W
	R _{θJ-L}	25								
	R _{θJ-C}	20								
Operating junction and storage temperature range	T _J , T _{STG}	-55 to +150								°C

Note : (1) Thermal resistance from junction to ambient and from junction to lead mounted on P.C.B. with 0.2" x 0.2" (5.0 mm x 5.0 mm) copper pad areas

CHARACTERISTIC CURVES

Fig. 1- I_o-TL Curve

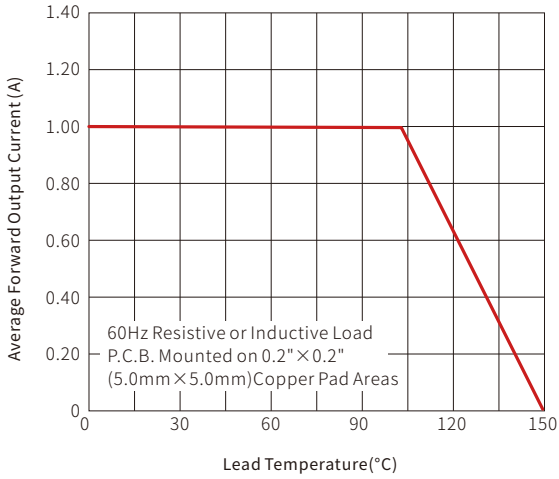

Fig. 2-Forward Surge Current Capability

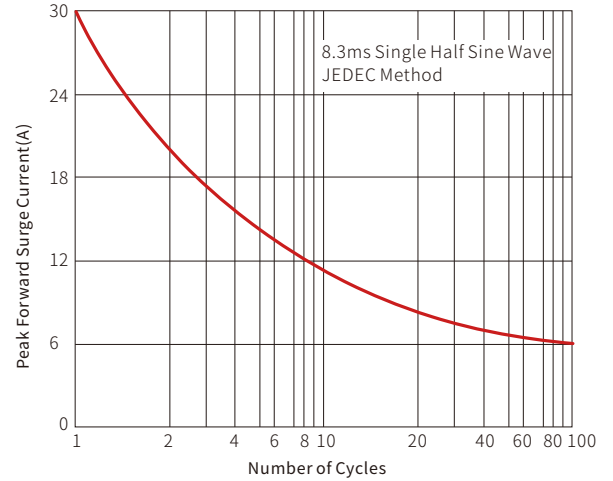

Fig. 3-Typical Forward Voltage

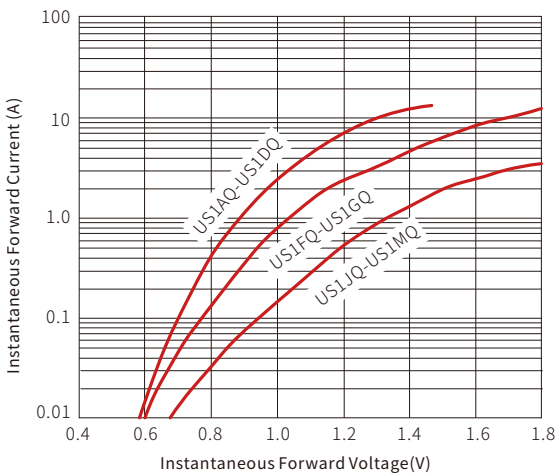

Fig. 4-Typical Reverse Characteristics

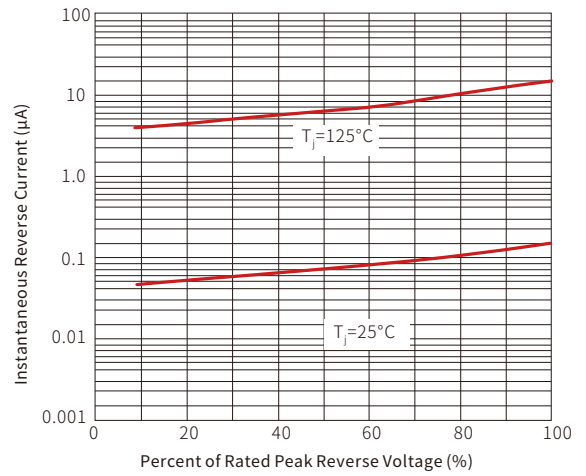
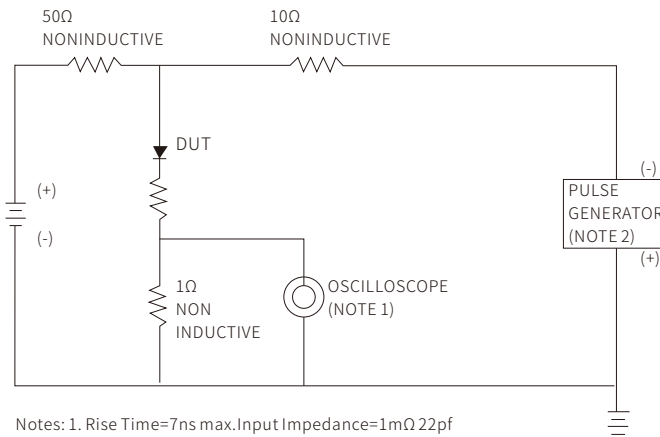
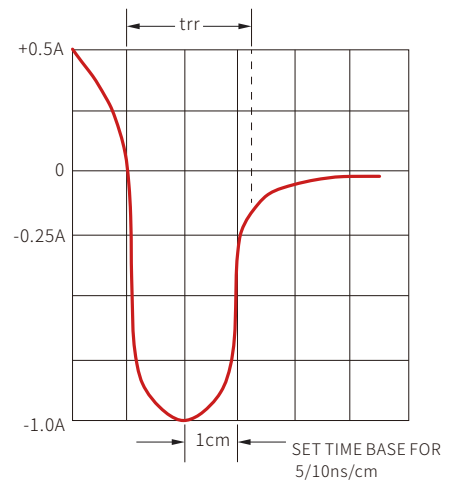

Fig. 5-Diagram of circuit and Testing wave form of reverse recovery time

Notes: 1. Rise Time=7ns max. Input Impedance=1mΩ 22pf
 2. Rise Time=10ns max. Source Impedance=50Ω



SOLDERING PARAMETERS

Reflow Condition		Lead-free assembly
Pre Heat	Temperature Max ($T_{s(min)}$)	150°C
	Temperature Max ($T_{s(max)}$)	200°C
	Time (min to max) (t_s)	60 – 180 secs
Average ramp up rate (Liquidus Temp (T_L) to peak)		3°C/second max
$T_{s(max)}$ to T_L - Ramp-up Rate		3°C/second max
Reflow	Temperature (T_L) (Liquidus)	217°C
	Time (min to max) (t_L)	60 – 150 seconds
Peak Temperature (T_p)		260°C
Time within 5°C of actual peak Temperature (t_p)		20 – 40 seconds
Ramp-down Rate		6°C/second max
Time 25°C to peak Temperature (T_p)		8 minutes max.
Do not exceed		260°C

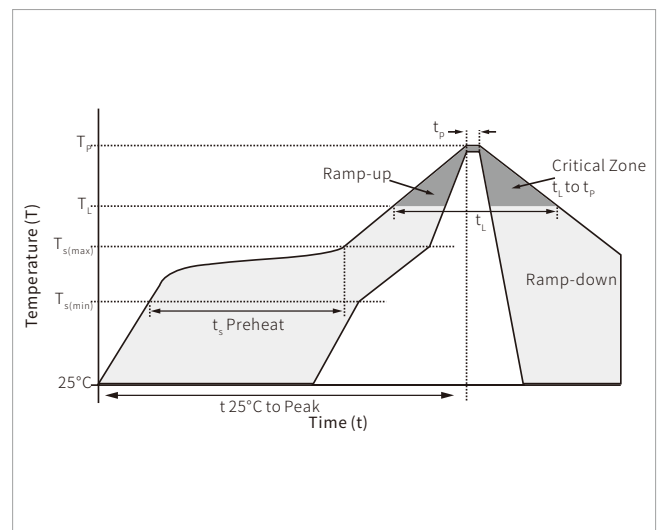

DO-214AC(SMA) PACKAGE INFORMATION

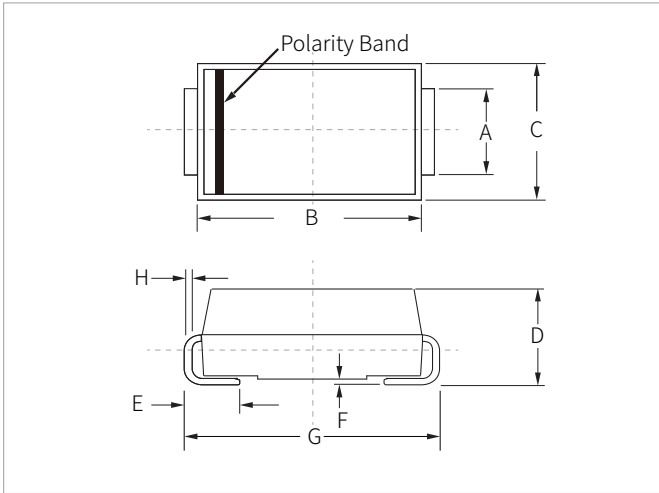

Ref.	Millimeters		Inches	
	Min.	Max.	Min.	Max.
A	1.20	1.60	0.047	0.063
B	4.20	4.60	0.165	0.181
C	2.40	2.80	0.094	0.110
D	2.00	2.40	0.079	0.094
E	0.76	1.52	0.030	0.060
F	0.02	0.20	0.001	0.008
G	4.85	5.25	0.191	0.207
H	0.15	0.30	0.006	0.012

RECOMMENDED PAD LAYOUT DIMENSIONS

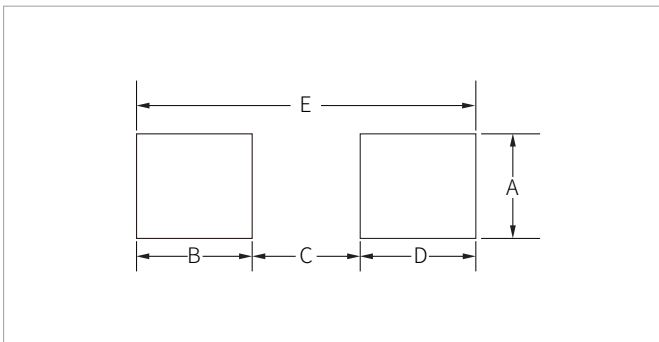

Ref.	Millimeters		Inches	
	Min.	Max.	Min.	Max.
A	1.63	-	0.064	-
B	1.45	-	0.057	-
C	-	2.80	-	0.090
D	1.45	-	0.057	-
E	5.28REF		0.208REF	

ORDERING INFORMATION

Part Number	Component Package	QTY/Reel	Reel Size
US1AQ-US1MQ	DO-214AC(SMA)	5000PCS	13"

Headquarters

No.3387 Shendu Road
Pujiang I&E Park
Minhang Shanghai China
201000

Hotline

400-021-5756

Web

<https://www.semiware.com>

Sales Center

Tel: 86-21-3463-7458
Email: sales18@semiware.com

Customer Service

Tel: 86-21-5484-1001
Email: sales17@semiware.com

Technical Support

Tel: 86-21-3463-7654
Email: fae01@semiware.com

Complaint & Suggestions

Tel: 86-21-3463-7172
Ext: 8868
Email: cs03@semiware.com

By QR Code

Website



Wechat

To find your local partner within Semiware's global website: www.semiware.com

© 2022 Semiware Semiconductor Inc.

The content of this document has been carefully checked and understood. However, neither Semiware nor its subsidiaries assume any liability whatsoever for any errors or inaccuracies of this document and the consequences thereof. Published specifications are subject to change without notice. Product suitability for any area of application must ultimately be determined by the customer. In all cases, products must never be operated outside their published specifications. Semiware does not guarantee the availability of all published products. This disclaimer shall be governed by substantive Chinese law and resulting disputes shall be settled by the courts at the place of business of Semiware. Latest publications and a complete disclaimer can be downloaded from the Semiware website. All trademarks recognized.