

## FEATURES

- | Glass Passivated Chip Junction
- | Ideal For Automated Placement
- | High Surge Current Capability
- | Super fast reverse recovery time

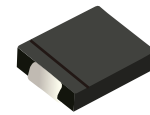

DO-214AB(SMC)



Schematic Symbol

## APPLICATIONS

- | For use in general purpose rectification of power supplies, inverters, converters, and freewheeling diodes for consumer, and telecommunication

## APPROVALS

<b>RoHS</b>	Compliance with 2011/65/EU
<b>HF</b>	Compliance with IEC61249-2-21:2003

## MAXIMUM RATINGS AND CHARACTERISTICS (T<sub>A</sub>=25°C)

Parameter	Symbol	US5A	US5B	US5D	US5F	US5G	US5J	US5K	US5M	Unit	
Marking		US5A	US5B	US5D	US5F	US5G	US5J	US5K	US5M		
Maximum repetitive peak reverse voltage	V <sub>RRM</sub>	50	100	200	300	400	600	800	1000	V	
Maximum RMS voltage	V <sub>RMS</sub>	35	70	140	210	280	420	560	700		
Maximum DC blocking voltage	V <sub>DC</sub>	50	100	200	300	400	600	800	1000		
Average Rectified Output Current @60Hz sine wave, Resistance load, TL (FIG.1)	I <sub>O</sub>	5.0									A
Forward Surge Current (Non-repetitive) @60Hz Half-sine wave, 1 cycle, T <sub>J</sub> =25°C	I <sub>FSM</sub>	150									
Forward Surge Current (Non-repetitive) @1ms, square wave, 1 cycle, T <sub>J</sub> =25°C		300									
Maximum instantaneous forward voltage I <sub>FM</sub> =5.0A	V <sub>F</sub>	1.0			1.3		1.7			V	
Maximum DC reverse current at rated DC blocking voltage	I <sub>R</sub>	5									μA
		100									
Typical junction capacitance Measured at 1MHz and Applied Reverse Voltage of 4.0 V.D.C	C <sub>J</sub>	72			46		52			pF	
Maximum reverse recovery time I <sub>F</sub> =0.5A, I <sub>R</sub> =1.0A, I <sub>rr</sub> =0.25A	t <sub>rr</sub>	50					75				ns
Current squared time @1ms ≤ t ≤ 8.3ms T <sub>J</sub> =25°C	I <sup>2</sup> t	94									A <sup>2</sup> s
Typical Thermal Resistance <sup>(1)</sup>	R <sub>θJ-A</sub>	48									°C/W
	R <sub>θJ-L</sub>	15									
	R <sub>θJ-C</sub>	12									
Operating junction and storage temperature range	T <sub>J</sub> , T <sub>STG</sub>	-55 to +150									°C

Note

(1) Thermal resistance from junction to ambient and from junction to lead mounted on P.C.B. with 0.6" x 0.6" (16 mm x 16 mm) copper pad areas

# CHARACTERISTIC CURVES

Fig. 1- I<sub>o</sub>-TL Curve

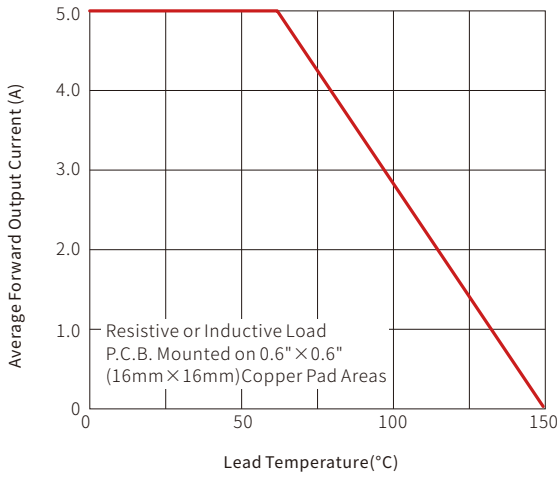

Fig. 2-Forward Surge Current Capability

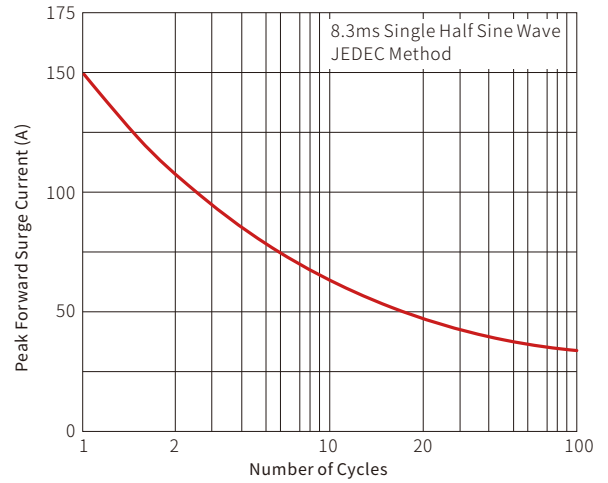

Fig. 3-Typical Forward Voltage

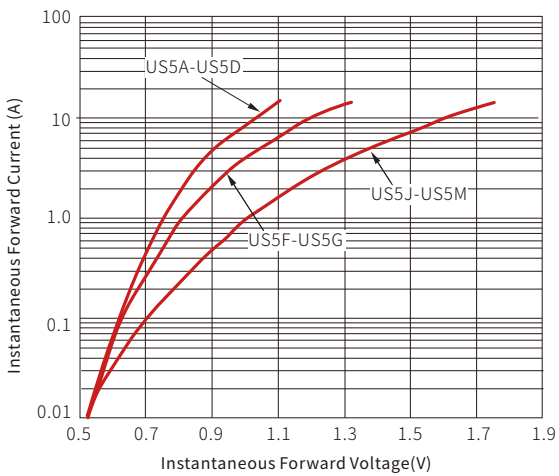
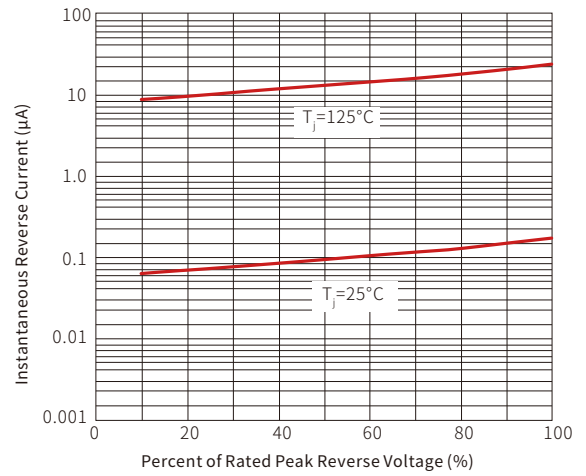
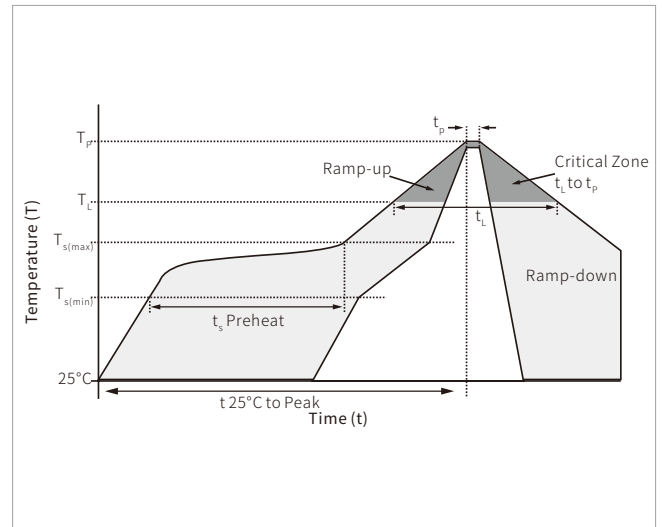

Fig. 4-Typical Reverse Characteristics



## SOLDERING PARAMETERS

Reflow Condition		Lead-free assembly
Pre Heat	Temperature Max ( $T_{s(min)}$ )	150°C
	Temperature Max ( $T_{s(max)}$ )	200°C
	Time (min to max) ( $t_s$ )	60 – 180 secs
Average ramp up rate (Liquidus Temp ( $T_L$ ) to peak)		3°C/second max
$T_{s(max)}$ to $T_L$ - Ramp-up Rate		3°C/second max
Reflow	Temperature ( $T_L$ ) (Liquidus)	217°C
	Time (min to max) ( $t_L$ )	60 – 150 seconds
Peak Temperature ( $T_p$ )		260°C
Time within 5°C of actual peak Temperature ( $t_p$ )		20 – 40 seconds
Ramp-down Rate		6°C/second max
Time 25°C to peak Temperature ( $T_p$ )		8 minutes max.
Do not exceed		260°C



## DO-214AB(SMC) PACKAGE INFORMATION

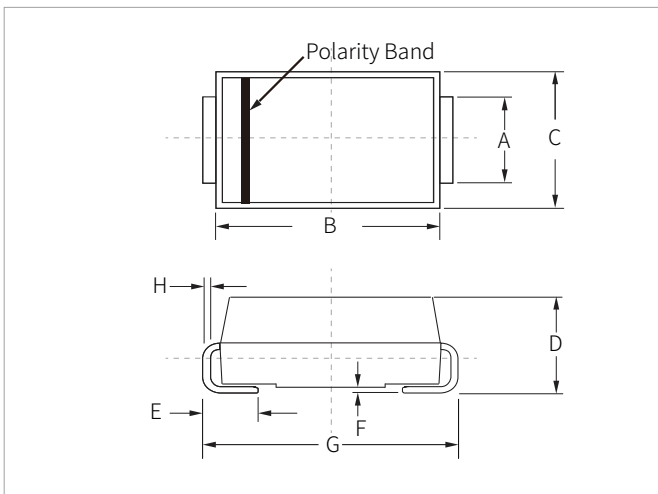

Ref.	Millimeters		Inches	
	Min.	Max.	Min.	Max.
A	2.80	3.20	0.110	0.126
B	6.60	7.20	0.260	0.283
C	5.70	6.10	0.224	0.240
D	2.15	2.75	0.085	0.108
E	1.00	1.60	0.039	0.063
F	0.02	0.20	0.000	0.008
G	7.60	8.00	0.299	0.315
H	0.15	0.30	0.006	0.012

## RECOMMENDED PAD LAYOUT DIMENSIONS

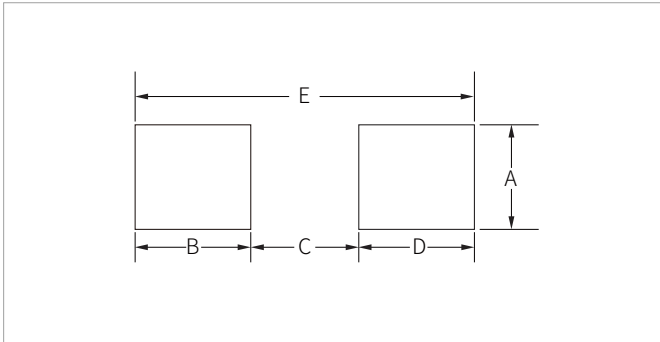

Ref.	Millimeters		Inches	
	Min.	Max.	Min.	Max.
A	3.30	-	0.129	-
B	2.40	-	0.094	-
C	-	4.20	-	0.165
D	2.40	-	0.094	-
E	8.20REF		0.323REF	

## ORDERING INFORMATION

Part Number	Component Package	QTY/Reel	Reel Size
US5A-US5M	DO-214AB(SMC)	3000PCS	13"

**Headquarters**

No.3387 Shendu Road  
Pujiang I&E Park  
Minhang Shanghai China  
201000

**Hotline**

400-021-5756

**Web**

<https://www.semiware.com>

**Sales Center**

Tel: 86-21-3463-7458  
Email: [sales18@semiware.com](mailto:sales18@semiware.com)

**Customer Service**

Tel: 86-21-5484-1001  
Email: [sales17@semiware.com](mailto:sales17@semiware.com)

**Technical Support**

Tel: 86-21-3463-7654  
Email: [fae01@semiware.com](mailto:fae01@semiware.com)

**Complaint & Suggestions**

Tel: 86-21-3463-7172  
Ext: 8868  
Email: [cs03@semiware.com](mailto:cs03@semiware.com)

**By QR Code**

Website



Wechat

To find your local partner within Semiware' s global website: [www.semiware.com](http://www.semiware.com)

© 2022 Semiware Semiconductor Inc.

The content of this document has been carefully checked and understood. However, neither Semiware nor its subsidiaries assume any liability whatsoever for any errors or inaccuracies of this document and the consequences thereof. Published specifications are subject to change without notice. Product suitability for any area of application must ultimately be determined by the customer. In all cases, products must never be operated outside their published specifications. Semiware does not guarantee the availability of all published products. This disclaimer shall be governed by substantive Chinese law and resulting disputes shall be settled by the courts at the place of business of Semiware. Latest publications and a complete disclaimer can be downloaded from the Semiware website. All trademarks recognized.